Description

The DIODES™ AZ1117C is a low dropout three-terminal regulator optimized for a low voltage where transient response and minimum input voltage are critical. The device provides current-limit and thermal-shutdown features. Its circuit includes a trimmed bandgap reference to assure output voltage accuracy of within $\pm 1\%$. On-chip thermal shutdown provides protection against a combination of high current and ambient temperature that would create excessive junction temperature.

The AZ1117C is available in 1.2V, 1.5V, 1.8V, 2.5V, 3.3V, and 5.0V fixed output voltage versions and an ADJ output voltage version. The fixed versions integrate the adjust resistors. It is also available in an adjustable version which can set the output voltage with two external resistors.

The AZ1117C is available in the industry-standard TO252-2 Series (including TO252-2 (3), TO252-2 (4), and TO252-2 (5)), SOT89, and SOT223 packages.

Features

- Current Limit: 1.35A (Typ)
- Output Noise from 10Hz to 10kHz: 0.003% of V_{OUT}
- PSRR at $I_{OUT} = 300\text{mA}$ and $f = 120\text{Hz}$: 70dB
- Output Voltage Accuracy: $\pm 1\%$ (Except 1.2V Version)
- On-Chip Thermal Shutdown
- Maximum Quiescent Current: $I_{QMAX} = 6\text{mA}$
- Compatible with Low ESR Ceramic Capacitor
- Operation Junction Temperature: -20°C to $+125^{\circ}\text{C}$
- **Totally Lead-Free & Fully RoHS Compliant (Notes 1 & 2)**
- **Halogen and Antimony Free. "Green" Device (Note 3)**
- **For automotive applications requiring specific change control (i.e. parts qualified to AEC-Q100/101/104/200, PPAP capable, and manufactured in IATF 16949 certified facilities), please [contact us](mailto:contact_us) or your local Diodes representative. <https://www.diodes.com/quality/product-definitions/>**

Applications

- USB devices
- Add-on cards
- DVD players
- PC motherboards

- Notes:
1. No purposely added lead. Fully EU Directive 2002/95/EC (RoHS), 2011/65/EU (RoHS 2) & 2015/863/EU (RoHS 3) compliant.
 2. See <https://www.diodes.com/quality/lead-free/> for more information about Diodes Incorporated's definitions of Halogen- and Antimony-free, "Green" and Lead-free.
 3. Halogen- and Antimony-free "Green" products are defined as those which contain <900ppm bromine, <900ppm chlorine (<1500ppm total Br + Cl) and <1000ppm antimony compounds.

Pin Assignments

(Top View)

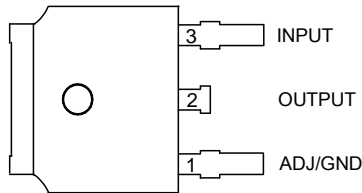

TO252-2 (3) Option 1

(Top View)

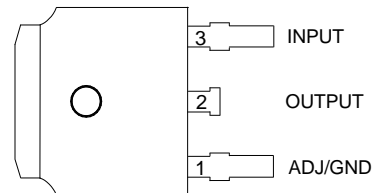

TO252-2 (3) Option 2 / TO252 (Type CJ)

(Top View)

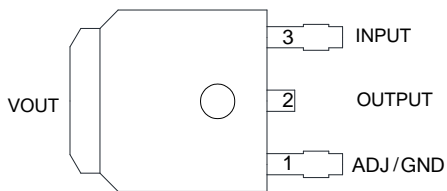

TO252-2 (4)

(Top View)

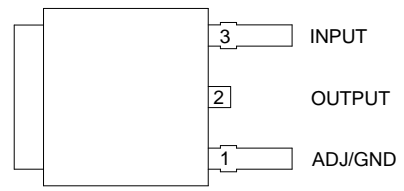

TO252-2 (5)

(Top View)

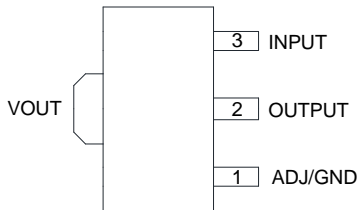

SOT89 Option 1/ R Package

(Top View)

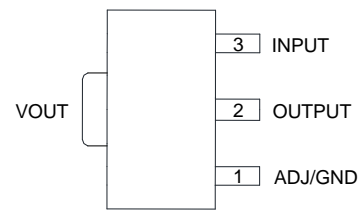

SOT89 Option 2/ R Package

(Top View)

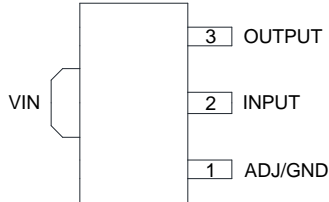

SOT89 Option 1/ R2 Package

(Top View)

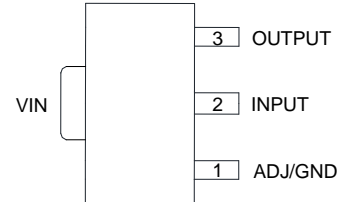

SOT89 Option 2/ R2 Package

(Top View)

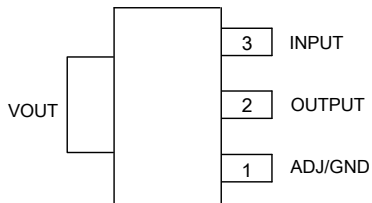

SOT223/ H Package

(Top View)

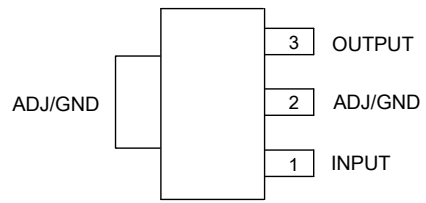

SOT223/ H2 Package

Typical Applications Circuit (Note 4)

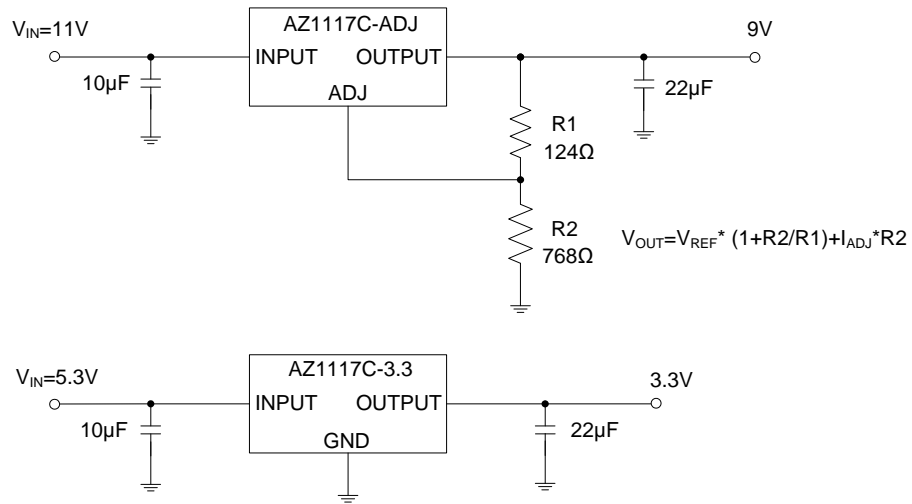

Note: 4. The AZ1117C is compatible with low ESR ceramic capacitor. The ESR of the output capacitors must be less than 20Ω. A minimum of 10µF output capacitor is required.

Functional Block Diagram

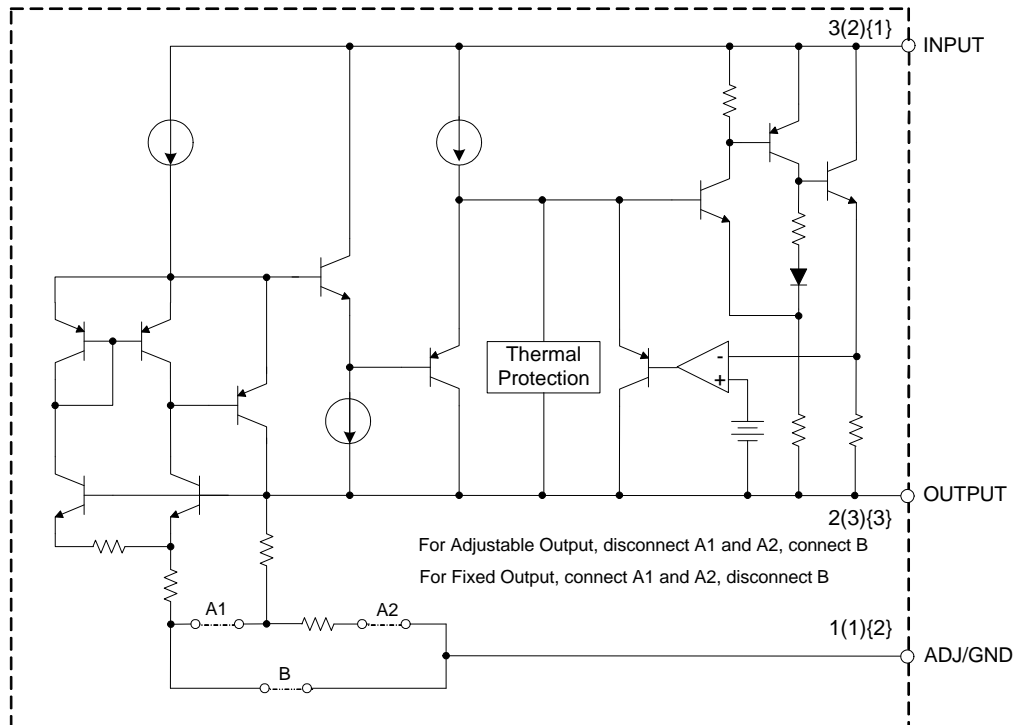

A(B){C}
A for TO252-2 Series/SOT223 (H)/SOT89 (R)
B for SOT89 (R2)
C for SOT223 (H2)

Absolute Maximum Ratings (Note 5)

Symbol	Parameter	Rating	Unit	
V _{IN}	Input Voltage	18	V	
T _J	Operating Junction Temperature Range	+150	°C	
T _{STG}	Storage Temperature Range	-65 to +150	°C	
θ _{JA}	Thermal Resistance (Without Heatsink)	SOT89	170	°C/W
		SOT223	125	
		TO252-2 Series	100	
θ _{JA}	Thermal Resistance (With Heatsink) (Note 6)	SOT89	150	°C/W
		SOT223	100	
		TO252-2 Series	70	
T _{LEAD}	Lead Temperature (Soldering, 10sec)	+260	°C	
—	ESD (Human Body Model)	4000	V	

Notes: 5. Stresses greater than those listed under "Absolute Maximum Ratings" may cause permanent damage to the device. These are stress ratings only, and functional operation of the device at these or any other conditions beyond those indicated under "Recommended Operating Conditions" is not implied. Exposure to "Absolute Maximum Ratings" for extended periods may affect device reliability.
6. Chip is soldered to 100mm²(10mm*10mm) copper (top side solder mask) on 2oz.2 layers FR-4 PCB with 8*0.5mm vias.

Recommended Operating Conditions

Symbol	Parameter	Min	Max	Unit
V _{IN}	Input Voltage	—	15	V
T _J	Operating Junction Temperature Range	-20	+125	°C

Electrical Characteristics AZ1117C-ADJ

(Operating Conditions: V_{IN} = V_{OUT}+2V, I_{OUT} = 10mA, T_J = +25°C, unless otherwise specified. (P ≤ maximum power dissipation). Limits appearing in **Boldface** type apply over the entire junction temperature range for operation, -20°C to +125°C.)

Symbol	Parameter	Conditions	Min	Typ	Max	Unit	
V _{REF}	Reference Voltage	1.5V ≤ V _{IN} -V _{OUT} ≤ 10V	1.238	1.250	1.262	V	
			1.225	1.250	1.270		
V _{RLINE}	Line Regulation	1.5V ≤ V _{IN} -V _{OUT} ≤ 10V	—	0.001	0.1	%	
			—	—	0.2		
V _{RLOAD}	Load Regulation	—	—	0.4	1.0	%	
V _{DROP}	Dropout Voltage	ΔV _{REF} = 1%, I _{OUT} = 0.8A	SOT223	—	1.2	1.3	V
			TO252-2 Series	—	1.3	1.4	V
I _{LIMIT}	Current Limit	—	1	1.35	—	A	
—	Adjust Pin Current	—	—	60	120	μA	
—	Adjust Pin Current Change	1.5 ≤ (V _{IN} -V _{OUT}) ≤ 10V	—	0.2	5	μA	
—	Minimum Load Current	1.5 ≤ (V _{IN} -V _{OUT}) ≤ 10V	—	1.7	5	mA	
PSRR	Ripple Rejection	f = 120Hz, C _{OUT} = 22μF (V _{IN} -V _{OUT}) = 3V, I _{OUT} = 300mA	—	70	—	dB	
—	Temperature Stability	—	—	0.5	—	%	
—	RMS Output Noise (% of V _{OUT})	T _A = +25°C, 10Hz ≤ f ≤ 10kHz	—	0.003	—	%	
—	Thermal Shutdown	Junction Temperature	—	+160	—	°C	
—	Thermal Shutdown Hysteresis	—	—	+16	—	°C	
θ _{JC}	Thermal Resistance (Junction to Case)	SOT89	—	30	—	°C/W	
		SOT223	—	15	—		
		TO252-2 Series	—	10	—		

Electrical Characteristics AZ1117C-1.2

(Operating Conditions: $V_{IN} \leq 10V$, $I_{OUT} = 10mA$, $T_J = +25^\circ C$, unless otherwise specified. ($P \leq$ maximum power dissipation). Limits appearing in **Boldface** type apply over the entire junction temperature range for operation, $-20^\circ C$ to $+125^\circ C$.)

Symbol	Parameter	Conditions	Min	Typ	Max	Unit
V_{OUT}	Output Voltage	$1.5V \leq V_{IN}-V_{OUT} \leq 10V$	1.176 1.152	1.2 1.2	1.224 1.228	V
V_{RLINE}	Line Regulation	$1.5V \leq V_{IN}-V_{OUT} \leq 10V$	—	0.5	6 10	mV
V_{RLOAD}	Load Regulation	—	—	2	15	mV
V_{DROP}	Dropout Voltage	$\Delta V_{OUT} = 1\%$, $I_{OUT} = 0.8A$	—	1.2	1.3	V
		SOT223	—	1.3	1.4	V
		TO252-2 Series	—	1.3	1.4	V
I_{LIMIT}	Current Limit	—	1	1.35	—	A
I_Q	Quiescent Current	$I_{OUT} = 0$	—	4	6	mA
PSRR	Ripple Rejection	$f = 120Hz$, $C_{OUT} = 22\mu F$ $(V_{IN}-V_{OUT}) = 3V$, $I_{OUT} = 300mA$	—	70	—	dB
—	Temperature Stability	—	—	0.5	—	%
—	RMS Output Noise (% of V_{OUT})	$T_A = +25^\circ C$, $10Hz \leq f \leq 10kHz$	—	0.003	—	%
—	Thermal Shutdown	Junction Temperature	—	+160	—	$^\circ C$
—	Thermal Shutdown Hysteresis	—	—	+16	—	$^\circ C$
θ_{JC}	Thermal Resistance (Junction to Case)	SOT89	—	30	—	$^\circ C/W$
		SOT223	—	15	—	
		TO252-2 Series	—	10	—	

Electrical Characteristics AZ1117C-1.5

(Operating Conditions: $V_{IN} \leq 10V$, $I_{OUT} = 10mA$, $T_J = +25^\circ C$, unless otherwise specified. ($P \leq$ maximum power dissipation). Limits appearing in **Boldface** type apply over the entire junction temperature range for operation, $-20^\circ C$ to $+125^\circ C$.)

Symbol	Parameter	Conditions	Min	Typ	Max	Unit
V_{OUT}	Output Voltage	$1.5V \leq V_{IN}-V_{OUT} \leq 10V$	1.485 1.470	1.5 1.5	1.515 1.530	V
V_{RLINE}	Line Regulation	$1.5V \leq V_{IN}-V_{OUT} \leq 10V$	—	0.5	6 10	mV
V_{RLOAD}	Load Regulation	—	—	2	15	mV
V_{DROP}	Dropout Voltage	$\Delta V_{OUT} = 1\%$, $I_{OUT} = 0.8A$	—	1.2	1.3	V
		SOT223	—	1.3	1.4	V
		TO252-2 Series	—	1.3	1.4	V
I_{LIMIT}	Current Limit	—	1	1.35	—	A
I_Q	Quiescent Current	$I_{OUT} = 0$	—	4	6	mA
PSRR	Ripple Rejection	$f = 120Hz$, $C_{OUT} = 22\mu F$ $(V_{IN}-V_{OUT}) = 3V$, $I_{OUT} = 300mA$	—	70	—	dB
—	Temperature Stability	—	—	0.5	—	%
—	RMS Output Noise (% of V_{OUT})	$T_A = +25^\circ C$, $10Hz \leq f \leq 10kHz$	—	0.003	—	%
—	Thermal Shutdown	Junction Temperature	—	+160	—	$^\circ C$
—	Thermal Shutdown Hysteresis	—	—	+16	—	$^\circ C$
θ_{JC}	Thermal Resistance (Junction to Case)	SOT89	—	30	—	$^\circ C/W$
		SOT223	—	15	—	
		TO252-2 Series	—	10	—	

Electrical Characteristics AZ1117C-1.8

(Operating Conditions: $V_{IN} \leq 10V$, $I_{OUT} = 10mA$, $T_J = +25^\circ C$, unless otherwise specified. ($P \leq$ maximum power dissipation). Limits appearing in **Boldface** type apply over the entire junction temperature range for operation, $-20^\circ C$ to $+125^\circ C$.)

Symbol	Parameter	Conditions	Min	Typ	Max	Unit	
V_{OUT}	Output Voltage	$1.5V \leq V_{IN}-V_{OUT} \leq 10V$	1.782	1.8	1.818	V	
			1.764	1.8	1.836		
V_{RLINE}	Line Regulation	$1.5V \leq V_{IN}-V_{OUT} \leq 10V$	—	0.5	6	mV	
			—	—	10		
V_{RLOAD}	Load Regulation	—	—	2	15	mV	
V_{DROP}	Dropout Voltage	$\Delta V_{OUT} = 1\%$, $I_{OUT} = 0.8A$	SOT223	—	1.2	1.3	V
			TO252-2 Series	—	1.3	1.4	V
I_{LIMIT}	Current Limit	—	1	1.35	—	A	
I_Q	Quiescent Current	$I_{OUT} = 0$	—	4	6	mA	
PSRR	Ripple Rejection	$f = 120Hz$, $C_{OUT} = 22\mu F$ $(V_{IN}-V_{OUT}) = 3V$, $I_{OUT} = 300mA$	—	70	—	dB	
—	Temperature Stability	—	—	0.5	—	%	
—	RMS Output Noise (% of V_{OUT})	$T_A = +25^\circ C$, $10Hz \leq f \leq 10kHz$	—	0.003	—	%	
—	Thermal Shutdown	Junction Temperature	—	+160	—	$^\circ C$	
—	Thermal Shutdown Hysteresis	—	—	+16	—	$^\circ C$	
θ_{JC}	Thermal Resistance (Junction to Case)	SOT89	—	30	—	$^\circ C/W$	
		SOT223	—	15	—		
		TO252-2 Series	—	10	—		

Electrical Characteristics AZ1117C-2.5

(Operating Conditions: $V_{IN} \leq 10V$, $I_{OUT} = 10mA$, $T_J = +25^\circ C$, unless otherwise specified. ($P \leq$ maximum power dissipation). Limits appearing in **Boldface** type apply over the entire junction temperature range for operation, $-20^\circ C$ to $+125^\circ C$.)

Symbol	Parameter	Conditions	Min	Typ	Max	Unit	
V_{OUT}	Output Voltage	$1.5V \leq V_{IN}-V_{OUT} \leq 10V$	2.475	2.5	2.525	V	
			2.455	2.5	2.545		
V_{RLINE}	Line Regulation	$1.5V \leq V_{IN}-V_{OUT} \leq 10V$	—	0.5	6	mV	
			—	—	10		
V_{RLOAD}	Load Regulation	—	—	2	15	mV	
V_{DROP}	Dropout Voltage	$\Delta V_{OUT} = 1\%$, $I_{OUT} = 0.8A$	SOT223	—	1.2	1.3	V
			TO252-2 Series	—	1.3	1.4	V
I_{LIMIT}	Current Limit	—	1	1.35	—	A	
I_Q	Quiescent Current	$I_{OUT} = 0$	—	4	6	mA	
PSRR	Ripple Rejection	$f = 120Hz$, $C_{OUT} = 22\mu F$ $(V_{IN}-V_{OUT}) = 3V$, $I_{OUT} = 300mA$	—	70	—	dB	
—	Temperature Stability	—	—	0.5	—	%	
—	RMS Output Noise (% of V_{OUT})	$T_A = +25^\circ C$, $10Hz \leq f \leq 10kHz$	—	0.003	—	%	
—	Thermal Shutdown	Junction Temperature	—	+160	—	$^\circ C$	
—	Thermal Shutdown Hysteresis	—	—	+16	—	$^\circ C$	
θ_{JC}	Thermal Resistance (Junction to Case)	SOT89	—	30	—	$^\circ C/W$	
		SOT223	—	15	—		
		TO252-2 Series	—	10	—		

Electrical Characteristics AZ1117C-3.3

(Operating Conditions: $V_{IN} \leq 10V$, $I_{OUT} = 10mA$, $T_J = +25^\circ C$, unless otherwise specified. ($P \leq$ maximum power dissipation). Limits appearing in **Boldface** type apply over the entire junction temperature range for operation, $-20^\circ C$ to $+125^\circ C$.)

Symbol	Parameter	Conditions	Min	Typ	Max	Unit
V_{OUT}	Output Voltage	$1.5V \leq V_{IN}-V_{OUT} \leq 10V$	3.267 3.235	3.3 3.3	3.333 3.365	V
V_{RLINE}	Line Regulation	$1.5V \leq V_{IN}-V_{OUT} \leq 10V$	—	0.5	6 10	mV
V_{RLOAD}	Load Regulation	—	—	2	15	mV
V_{DROP}	Dropout Voltage	$\Delta V_{OUT} = 1\%$, $I_{OUT} = 0.8A$	—	1.2	1.3	V
		SOT223	—	1.3	1.4	V
		TO252-2 Series	—	1.3	1.4	V
I_{LIMIT}	Current Limit	—	1	1.35	—	A
I_Q	Quiescent Current	$I_{OUT} = 0$	—	4	6	mA
PSRR	Ripple Rejection	$f = 120Hz$, $C_{OUT} = 22\mu F$ $(V_{IN}-V_{OUT}) = 3V$, $I_{OUT} = 300mA$	—	70	—	dB
—	Temperature Stability	—	—	0.5	—	%
—	RMS Output Noise (% of V_{OUT})	$T_A = +25^\circ C$, $10Hz \leq f \leq 10kHz$	—	0.003	—	%
—	Thermal Shutdown	Junction Temperature	—	+160	—	$^\circ C$
—	Thermal Shutdown Hysteresis	—	—	+16	—	$^\circ C$
θ_{JC}	Thermal Resistance (Junction to Case)	SOT89	—	30	—	$^\circ C/W$
		SOT223	—	15	—	
		TO252-2 Series	—	10	—	

Electrical Characteristics AZ1117C-5.0

(Operating Conditions: $V_{IN} \leq 10V$, $I_{OUT} = 10mA$, $T_J = +25^\circ C$, unless otherwise specified. ($P \leq$ maximum power dissipation). Limits appearing in **Boldface** type apply over the entire junction temperature range for operation, $-20^\circ C$ to $+125^\circ C$.)

Symbol	Parameter	Conditions	Min	Typ	Max	Unit
V_{OUT}	Output Voltage	$1.5V \leq V_{IN}-V_{OUT} \leq 10V$	4.950 4.900	5.0 5.0	5.050 5.100	V
V_{RLINE}	Line Regulation	$1.5V \leq V_{IN}-V_{OUT} \leq 10V$	—	0.5	6 10	mV
V_{RLOAD}	Load Regulation	—	—	2	15	mV
V_{DROP}	Dropout Voltage	$\Delta V_{OUT} = 1\%$, $I_{OUT} = 0.8A$	—	1.2	1.3	V
		SOT223	—	1.3	1.4	V
		TO252-2 Series	—	1.3	1.4	V
I_{LIMIT}	Current Limit	—	1	1.35	—	A
I_Q	Quiescent Current	$I_{OUT} = 0$	—	4	6	mA
PSRR	Ripple Rejection	$f = 120Hz$, $C_{OUT} = 22\mu F$ $(V_{IN}-V_{OUT}) = 3V$, $I_{OUT} = 300mA$	—	70	—	dB
—	Temperature Stability	—	—	0.5	—	%
—	RMS Output Noise (% of V_{OUT})	$T_A = +25^\circ C$, $10Hz \leq f \leq 10kHz$	—	0.003	—	%
—	Thermal Shutdown	Junction Temperature	—	+160	—	$^\circ C$
—	Thermal Shutdown Hysteresis	—	—	+16	—	$^\circ C$
θ_{JC}	Thermal Resistance (Junction to Case)	SOT89	—	30	—	$^\circ C/W$
		SOT223	—	15	—	
		TO252-2 Series	—	10	—	

Performance Characteristics

Line Regulation vs. Junction Temperature

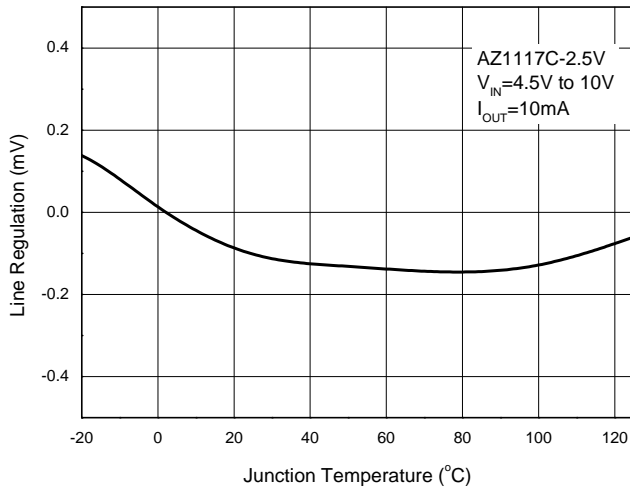

Load Regulation vs. Junction Temperature

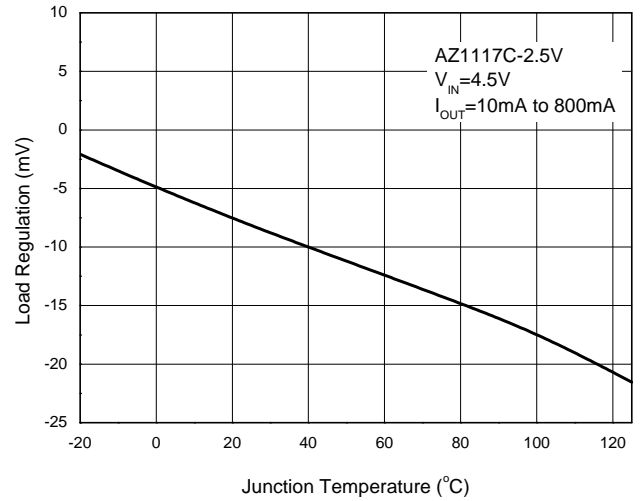

Reference Voltage vs. Junction Temperature

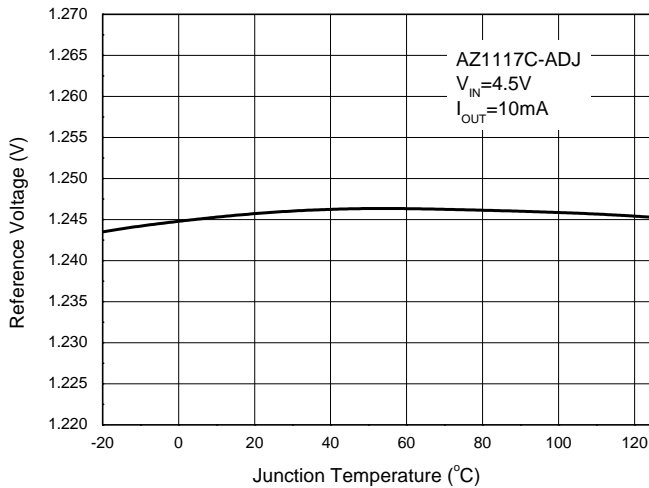

Output Voltage vs. Junction Temperature

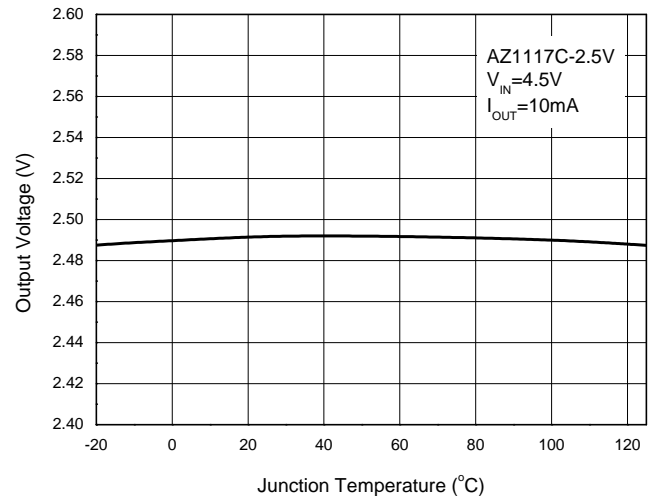

Minimum Load Current vs. Junction Temperature

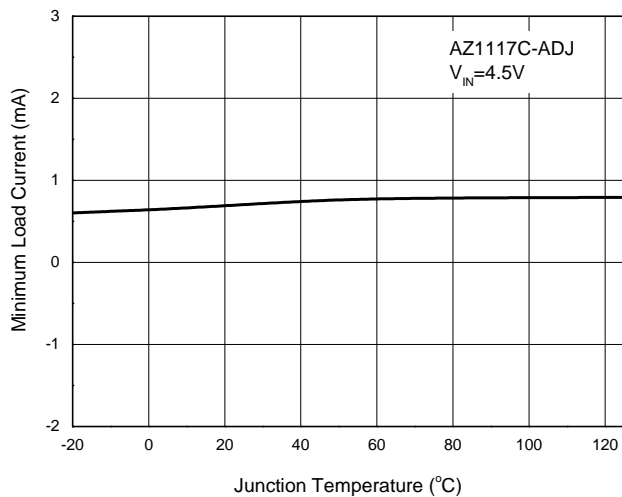

Adjust Pin Current vs. Junction Temperature

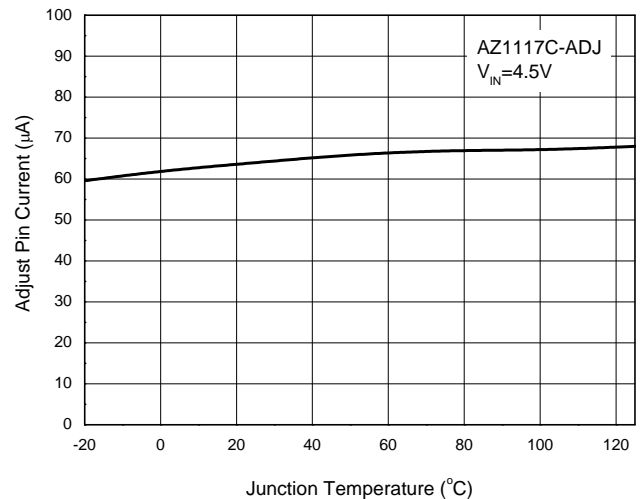

Performance Characteristics (continued)

Dropout Voltage vs. Output Current

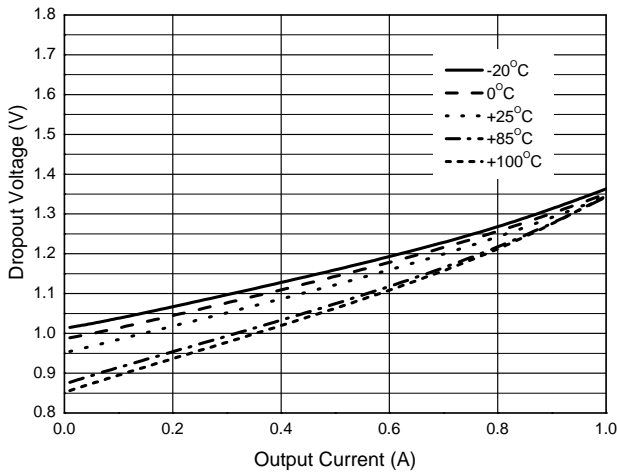

Power Dissipation vs. Case Temperature

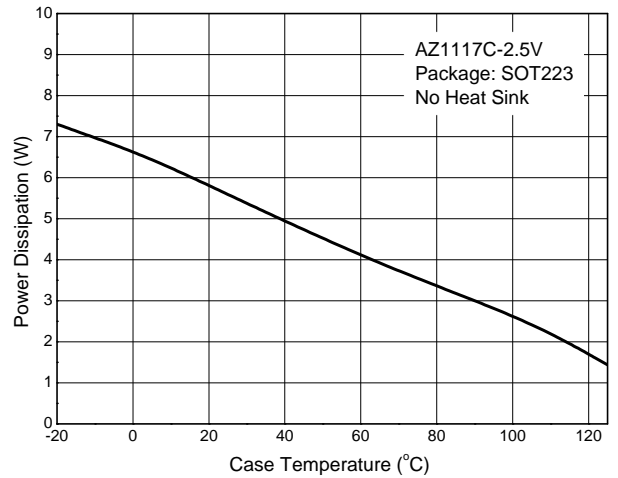

Line Transient Response

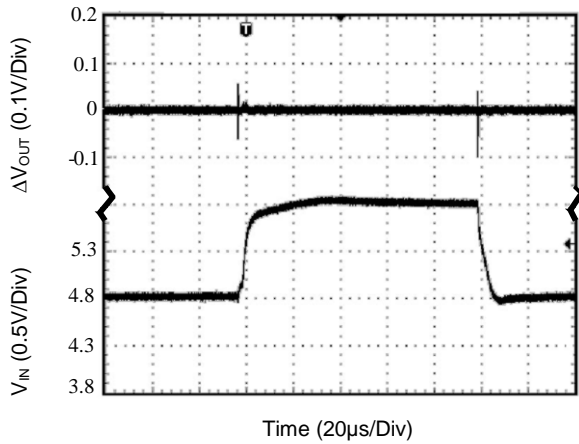

Load Transient Response

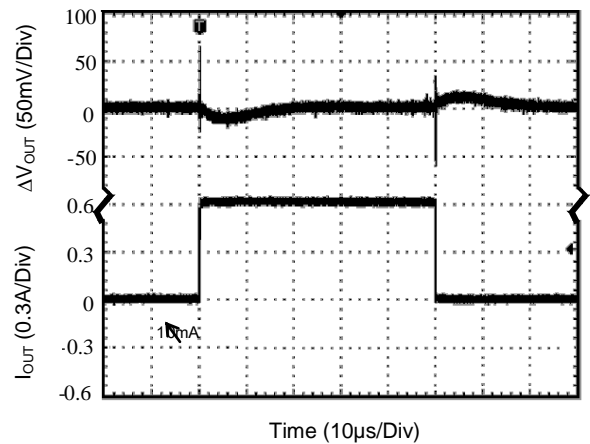

PSRR vs. Frequency

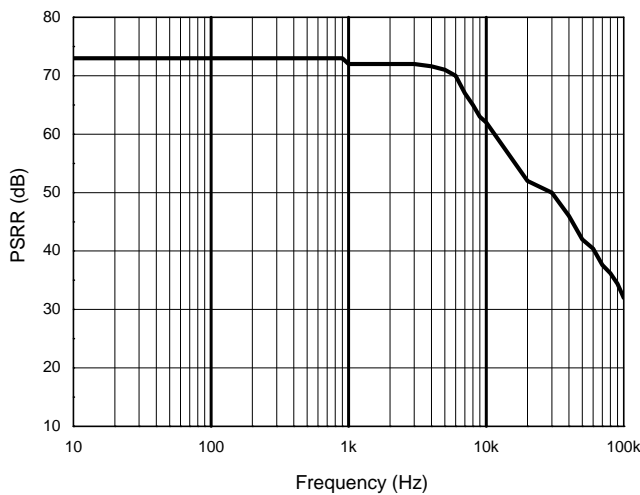

Current Limit vs. Junction Temperature

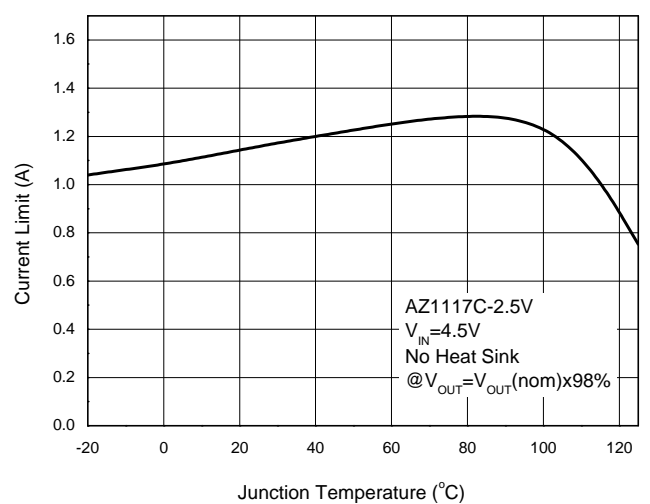

Performance Characteristics (continued)

Dropout Voltage vs. Junction Temperature

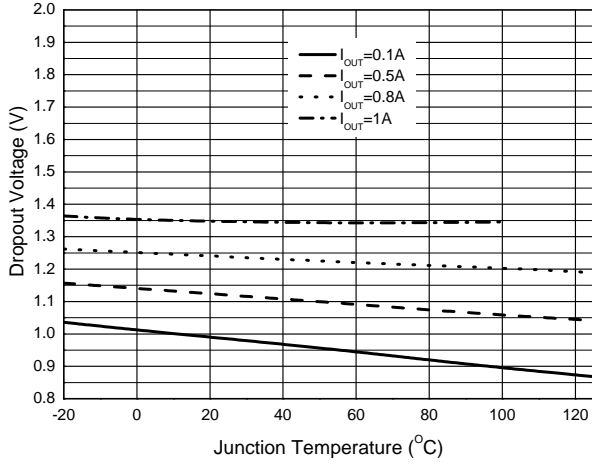

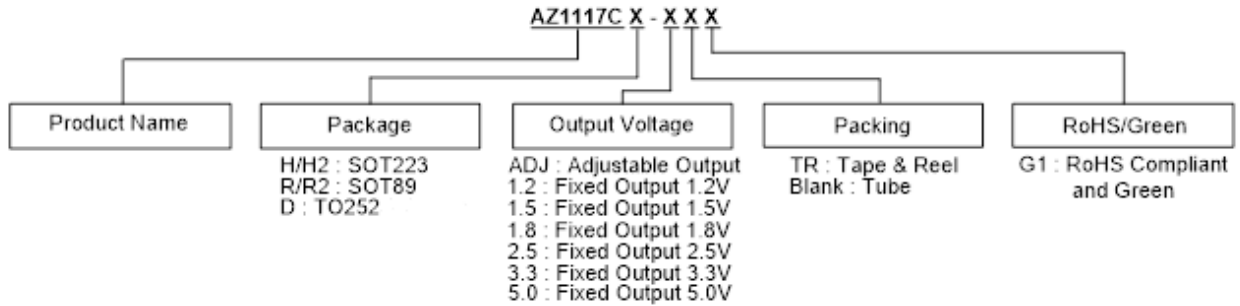
Ordering Information

Package	Temperature Range	Part Number	Marking ID	Packing
SOT223	-20°C to +125°C	AZ1117CH-ADJTRG1	GH15B	4000/Tape & Reel
		AZ1117CH-1.2TRG1	GH16B	4000/Tape & Reel
		AZ1117CH-1.5TRG1	GH15C	4000/Tape & Reel
		AZ1117CH-1.8TRG1	GH16C	4000/Tape & Reel
		AZ1117CH-2.5TRG1	GH15D	4000/Tape & Reel
		AZ1117CH-3.3TRG1	GH16D	4000/Tape & Reel
SOT223		AZ1117CH-5.0TRG1	GH15E	4000/Tape & Reel
		AZ1117CH2-ADJTRG1	GH14H	4000/Tape & Reel
		AZ1117CH2-1.2TRG1	GH15H	4000/Tape & Reel
		AZ1117CH2-1.5TRG1	GH17H	4000/Tape & Reel
		AZ1117CH2-1.8TRG1	GH27H	4000/Tape & Reel
		AZ1117CH2-2.5TRG1	GH28H	4000/Tape & Reel
SOT89	-20°C to +125°C	AZ1117CH2-3.3TRG1	GH38H	4000/Tape & Reel
		AZ1117CH2-5.0TRG1	GH13H	4000/Tape & Reel
		AZ1117CR-ADJTRG1	G27N	1000/Tape & Reel
		AZ1117CR-1.2TRG1	G28J	1000/Tape & Reel
		AZ1117CR-1.5TRG1	G28K	1000/Tape & Reel
		AZ1117CR-1.8TRG1	G28L	1000/Tape & Reel
SOT89		AZ1117CR-2.5TRG1	G28M	1000/Tape & Reel
		AZ1117CR-3.3TRG1	G28N	1000/Tape & Reel
		AZ1117CR-5.0TRG1	G27M	1000/Tape & Reel
		AZ1117CR2-ADJTRG1	G42O	1000/Tape & Reel
		AZ1117CR2-1.2TRG1	G43M	1000/Tape & Reel
		AZ1117CR2-1.5TRG1	G43N	1000/Tape & Reel
TO252-2 (3)/(4)/(5) TO252 (Type CJ)	-20°C to +125°C	AZ1117CR2-1.8TRG1	G43O	1000/Tape & Reel
		AZ1117CR2-2.5TRG1	G70M	1000/Tape & Reel
		AZ1117CR2-3.3TRG1	G70N	1000/Tape & Reel
		AZ1117CR2-5.0TRG1	G33N	1000/Tape & Reel
		AZ1117CD-ADJG1	AZ1117CD-ADJG1	80/Tube
		AZ1117CD-ADJTRG1	AZ1117CD-ADJG1	2500/Tape & Reel
		AZ1117CD-1.2G1	AZ1117CD-1.2G1	80/Tube
		AZ1117CD-1.2TRG1	AZ1117CD-1.2G1	2500/Tape & Reel
		AZ1117CD-1.5G1	AZ1117CD-1.5G1	80/Tube
		AZ1117CD-1.5TRG1	AZ1117CD-1.5G1	2500/Tape & Reel
		AZ1117CD-1.8G1	AZ1117CD-1.8G1	80/Tube
		AZ1117CD-1.8TRG1	AZ1117CD-1.8G1	2500/Tape & Reel
AZ1117CD-2.5G1	AZ1117CD-2.5G1	80/Tube		
AZ1117CD-2.5TRG1	AZ1117CD-2.5G1	2500/Tape & Reel		
AZ1117CD-3.3G1	AZ1117CD-3.3G1	80/Tube		
AZ1117CD-3.3TRG1	AZ1117CD-3.3G1	2500/Tape & Reel		
AZ1117CD-5.0G1	AZ1117CD-5.0G1	80/Tube		
AZ1117CD-5.0TRG1	AZ1117CD-5.0G1	2500/Tape & Reel		

Marking Information

(1) SOT223 Series

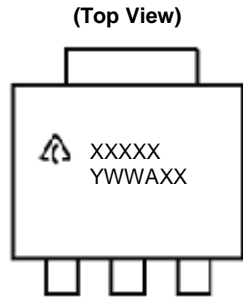

First Line: Logo and Marking ID
(See Ordering Information)
Second Line: Date Code
Y: Year
WW: Work Week of Molding
A: Assembly House Code
XX: 7th and 8th Digits of Batch Number

(2) TO252-2 Series/ TO252 (Type CJ)

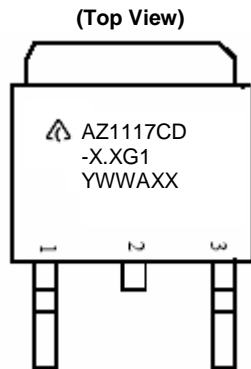

First and Second Lines: Logo and Marking ID
(See Ordering Information)
Third Line: Date Code
Y: Year
WW: Work Week of Molding
A: Assembly House Code
XX: 7th and 8th Digits of Batch Number

(3) SOT89 Series

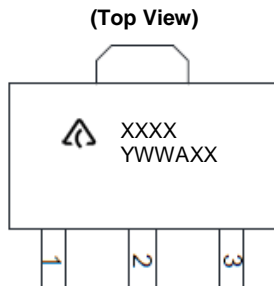

First Line: Logo and Marking ID
(See Ordering Information)
Second Line: Date Code
Y: Year
WW: Work Week of Molding
A: Assembly House Code
XX: 7th and 8th Digits of Batch Number

Package Outline Dimensions (All dimensions in mm)

Please see <http://www.diodes.com/package-outlines.html> for the latest version.

(1) Package Type: SOT223

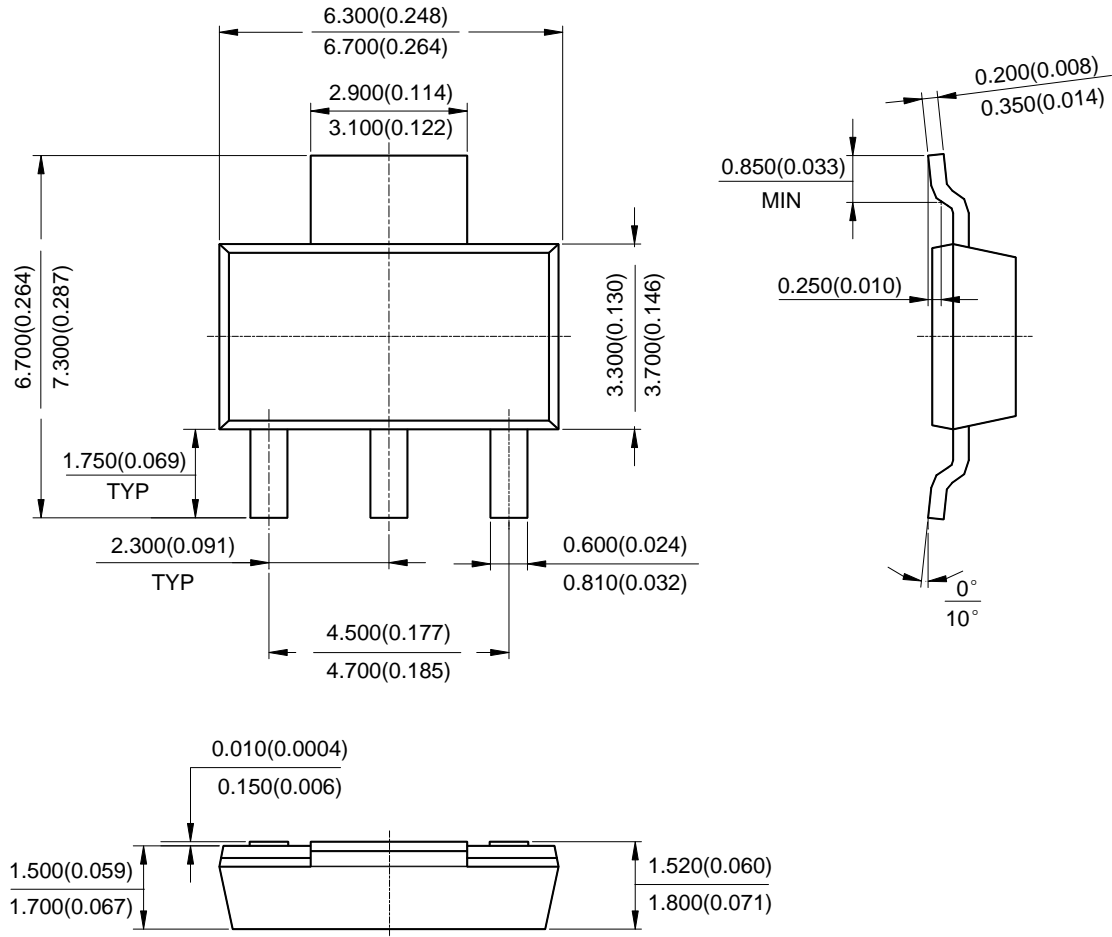

Package Outline Dimensions (All dimensions in mm) (continued)

Please see <http://www.diodes.com/package-outlines.html> for the latest version.

(2) Package Type: SOT89

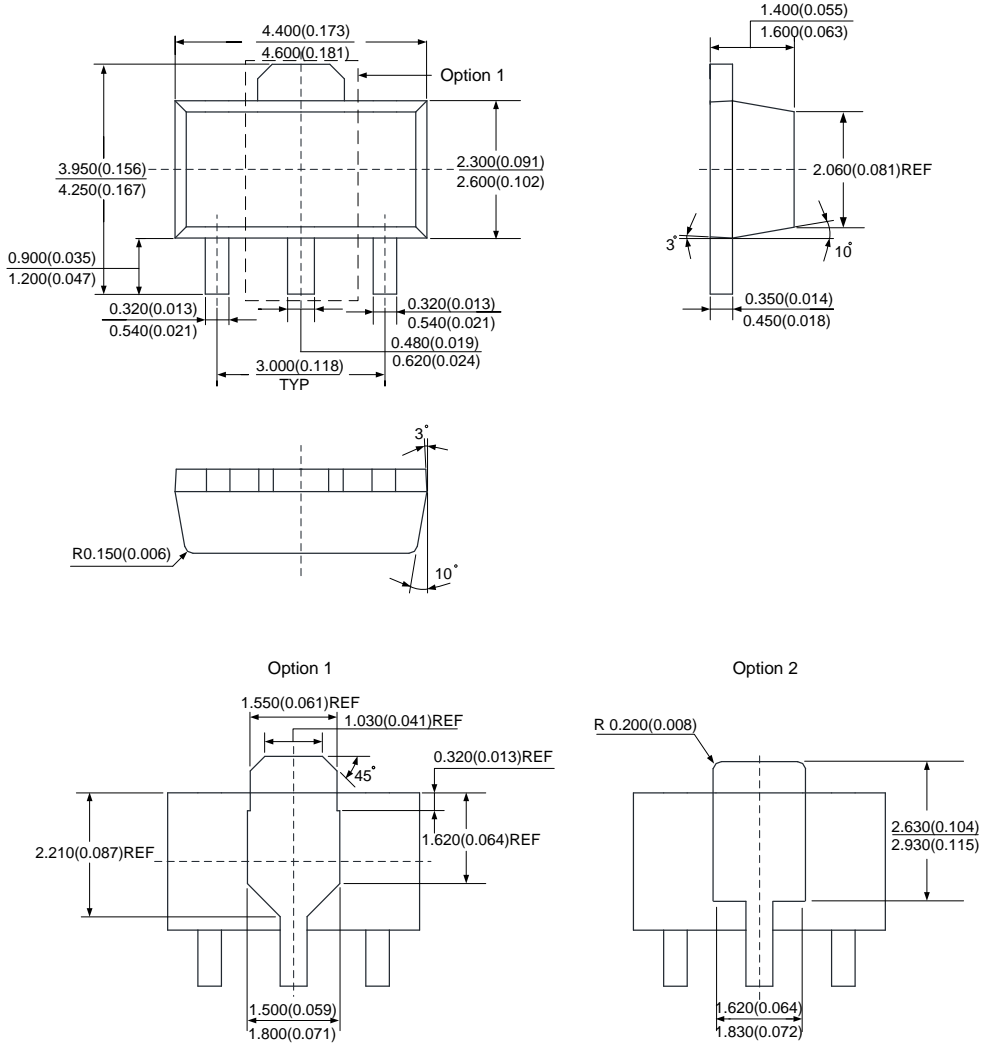

Package Outline Dimensions (All dimensions in mm) (continued)

Please see <http://www.diodes.com/package-outlines.html> for the latest version.

(3) Package Type: TO252-2 (3)

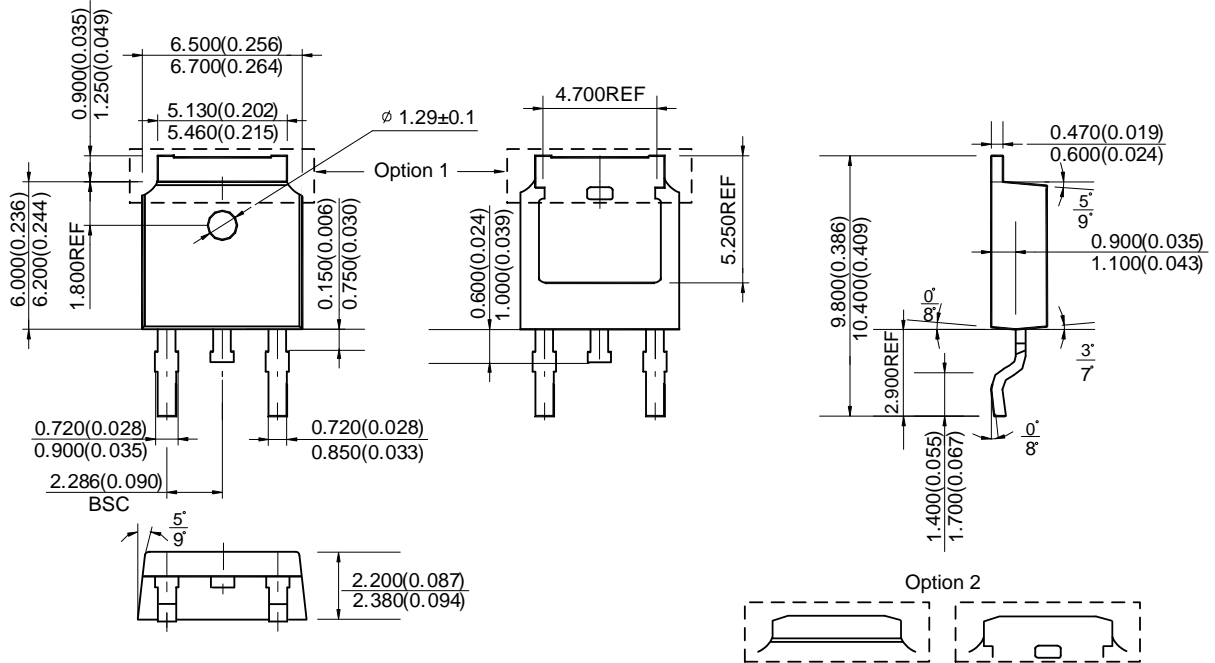

Package Outline Dimensions (All dimensions in mm) (continued)

Please see <http://www.diodes.com/package-outlines.html> for the latest version.

(4) Package Type: TO252-2 (4)

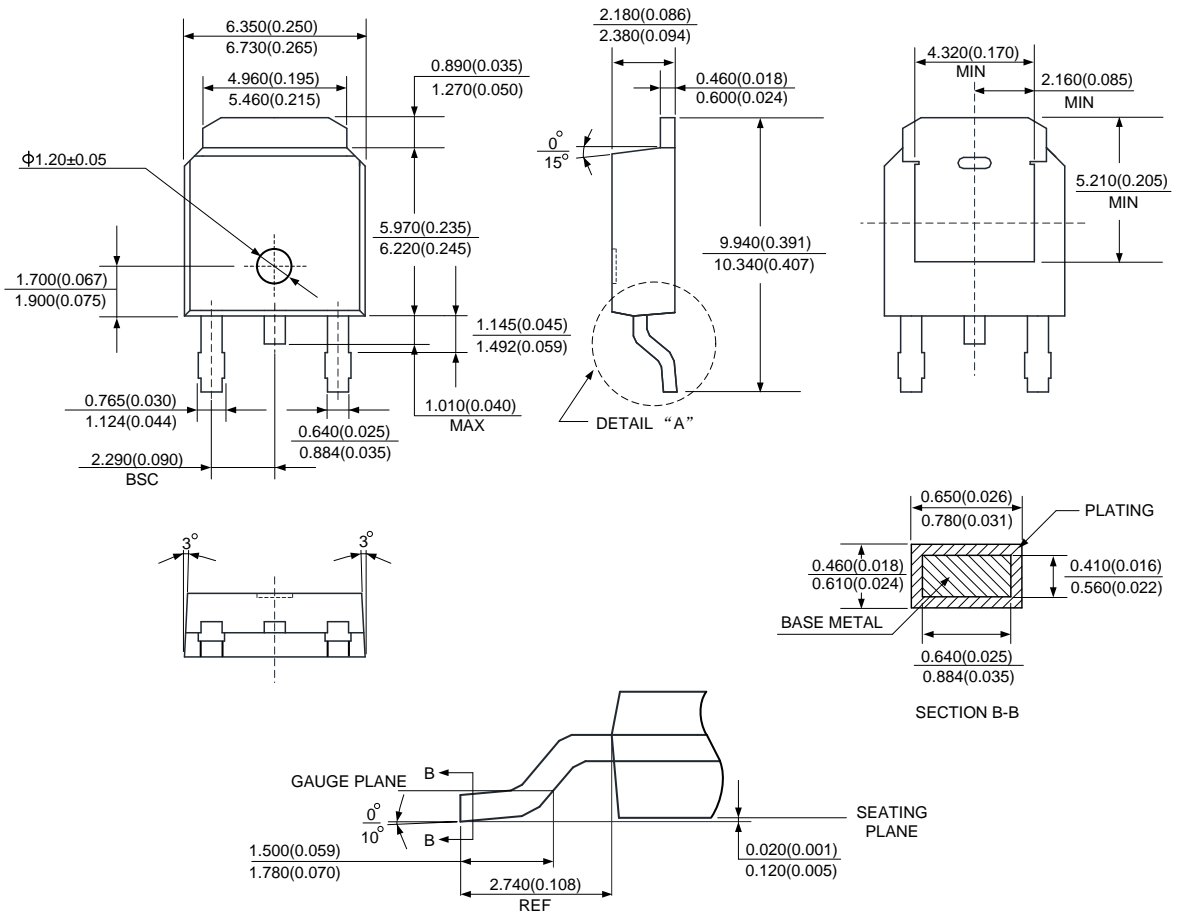

Package Outline Dimensions (All dimensions in mm) (continued)

Please see <http://www.diodes.com/package-outlines.html> for the latest version.

(5) Package Type: TO252-2 (5)

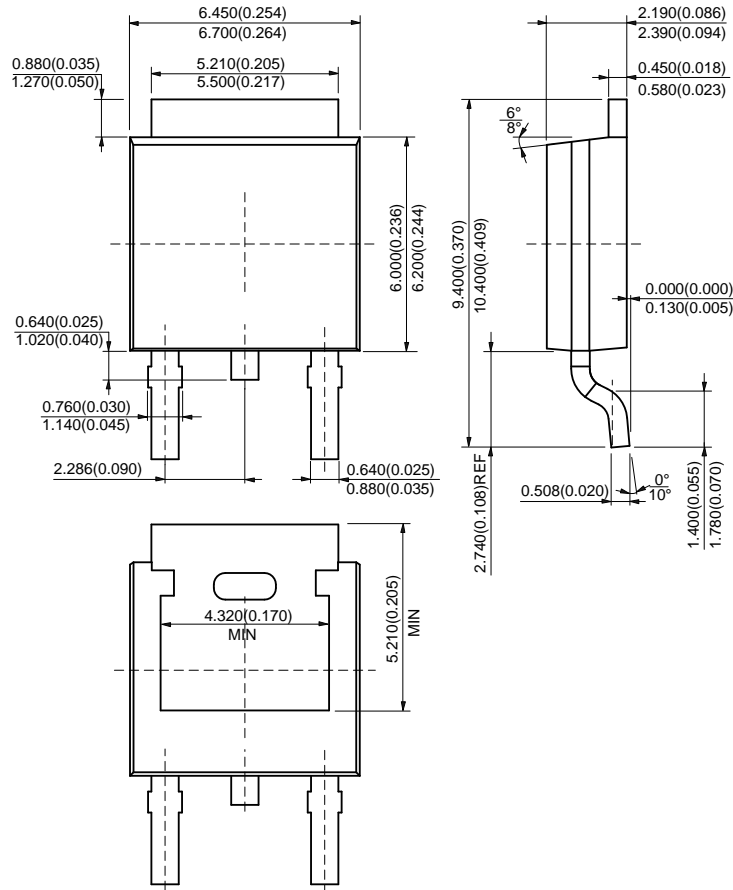

Package Outline Dimensions (All dimensions in mm) (continued)

Please see <http://www.diodes.com/package-outlines.html> for the latest version.

(6) Package Type : TO252 (Type CJ)

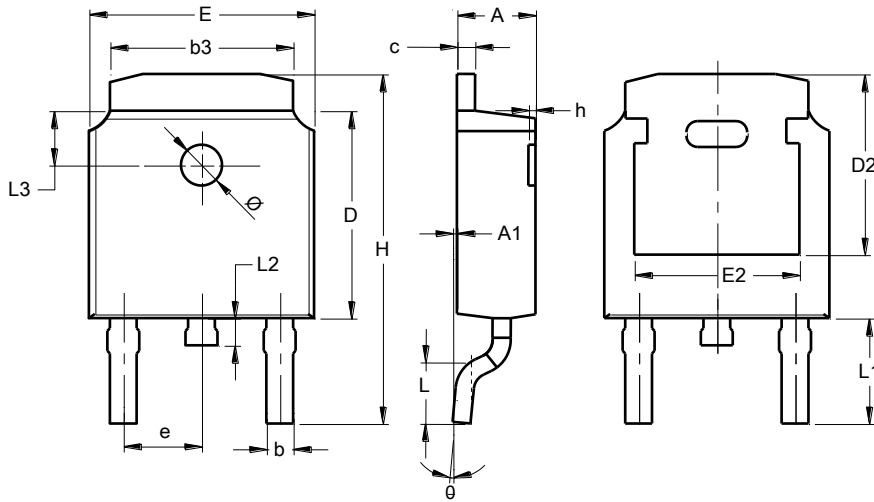

TO252 (Type CJ)			
Dim	Min	Max	Typ
A	2.200	2.400	--
A1	0.000	0.127	--
b	0.635	0.770	--
b3	5.100	5.460	--
c	0.460	0.580	--
D	6.000	6.200	--
D2	5.250 REF		--
E	6.500	6.700	--
E2	4.830 REF		--
e	2.186	2.386	--
h	0.000	0.300	--
H	9.712	10.312	--
L	1.400	1.700	--
L1	2.900 REF		--
L2	0.600	1.000	--
L3	1.600 REF		--
Ø	1.100	1.300	--
θ	0°	8°	--
All Dimensions in mm			

Suggested Pad Layout

Please see <http://www.diodes.com/package-outlines.html> for the latest version.

(1) Package Type: SOT223

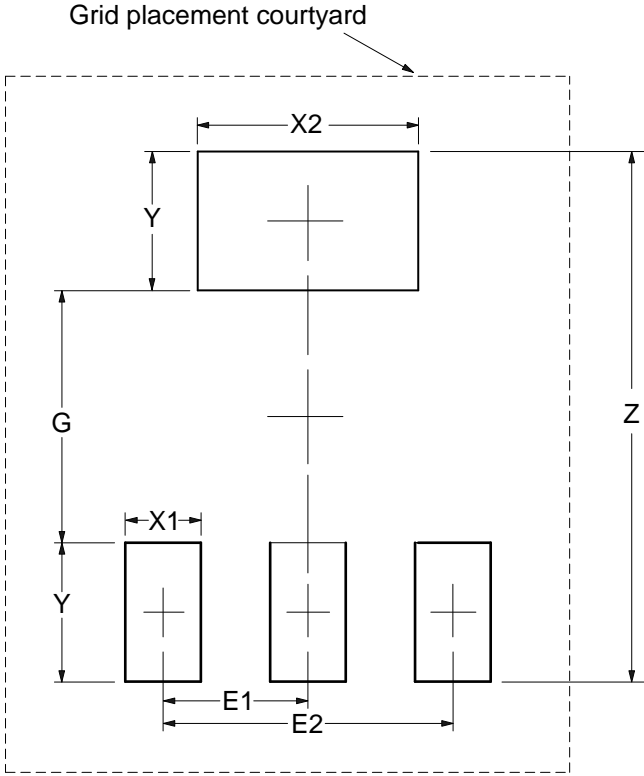

Dimensions	Z (mm)/(inch)	G (mm)/(inch)	X1 (mm)/(inch)	X2 (mm)/(inch)	Y (mm)/(inch)	E1 (mm)/(inch)	E2 (mm)/(inch)
Value	8.400/0.331	4.000/0.157	1.200/0.047	3.500/0.138	2.200/0.087	2.300/0.091	4.600/0.181

Suggested Pad Layout (continued)

Please see <http://www.diodes.com/package-outlines.html> for the latest version.

(2) Package Type: SOT89

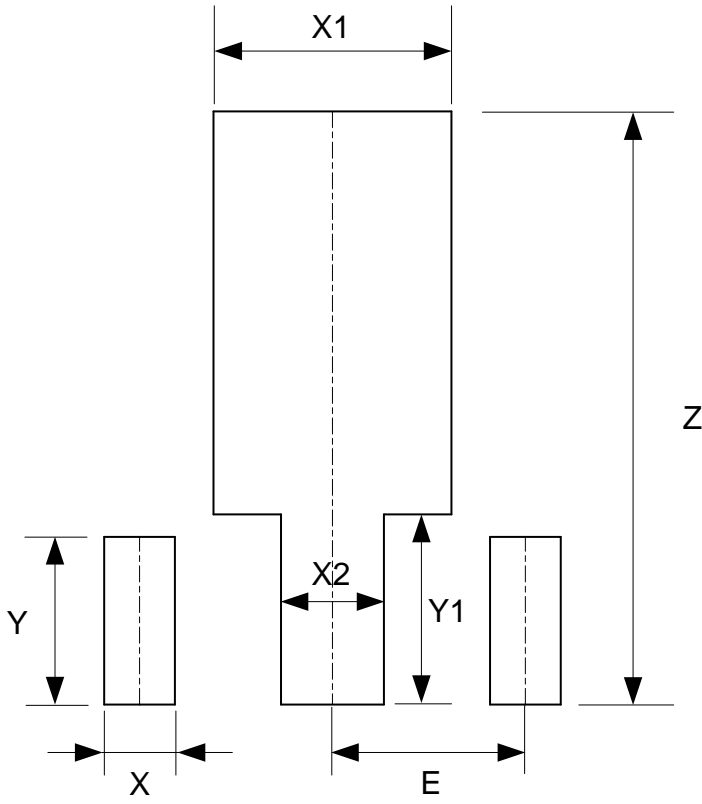

Dimensions	Z (mm)/(inch)	X (mm)/(inch)	X1 (mm)/(inch)	X2 (mm)/(inch)	Y (mm)/(inch)	Y1 (mm)/(inch)	E (mm)/(inch)
Value	4.600/0.181	0.550/0.022	1.850/0.073	0.800/0.031	1.300/0.051	1.475/0.058	1.500/0.059

Suggested Pad Layout (continued)

Please see <http://www.diodes.com/package-outlines.html> for the latest version.

(3) Package Type: TO252-2 (3) / TO252 (Type CJ)

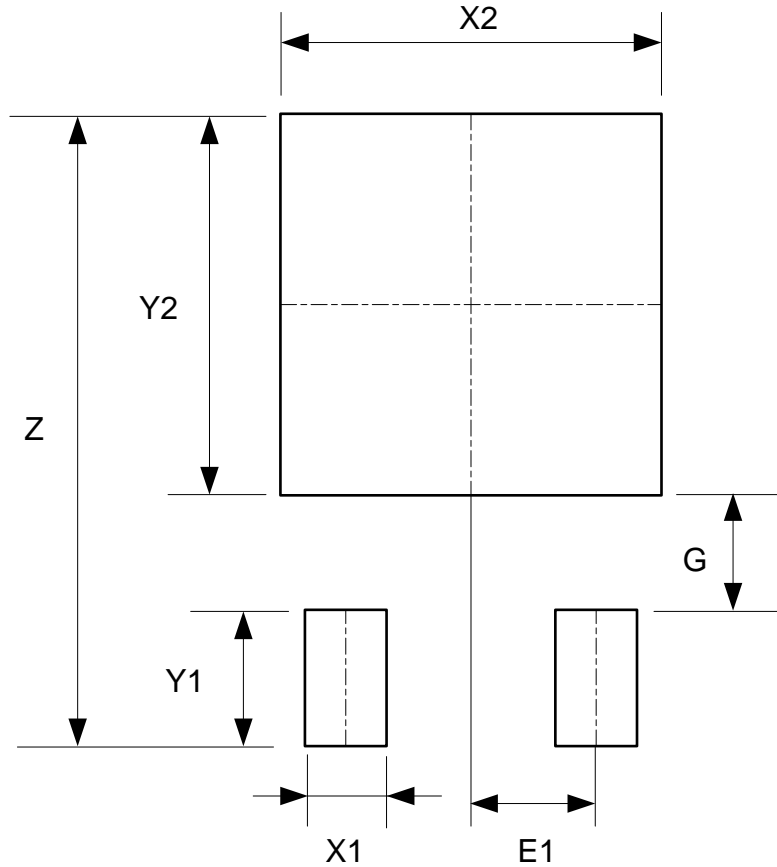

Dimensions	Z (mm)/(inch)	X1 (mm)/(inch)	X2=Y2 (mm)/(inch)	Y1 (mm)/(inch)	G (mm)/(inch)	E1 (mm)/(inch)
Value	11.600/0.457	1.500/0.059	7.000/0.276	2.500/0.098	2.100/0.083	2.300/0.091

Suggested Pad Layout (continued)

Please see <http://www.diodes.com/package-outlines.html> for the latest version.

(4) Package Type: TO252-2 (4)

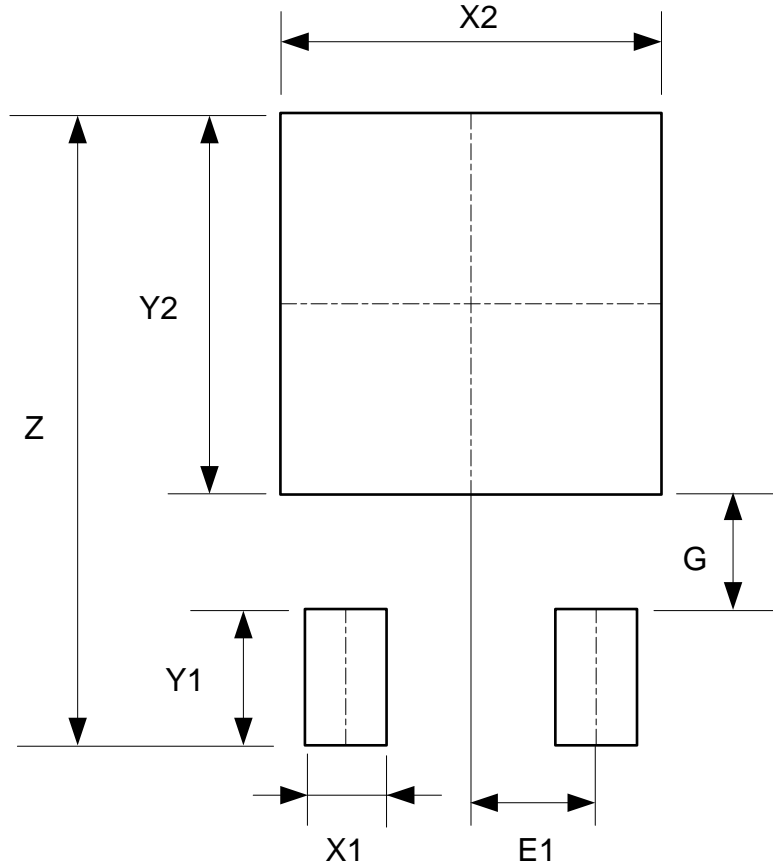

Dimensions	Z (mm)/(inch)	X1 (mm)/(inch)	X2=Y2 (mm)/(inch)	Y1 (mm)/(inch)	G (mm)/(inch)	E1 (mm)/(inch)
Value	11.600/0.457	1.500/0.059	7.000/0.276	2.500/0.098	2.100/0.083	2.300/0.091

Suggested Pad Layout (continued)

Please see <http://www.diodes.com/package-outlines.html> for the latest version.

(5) Package Type: TO252-2 (5)

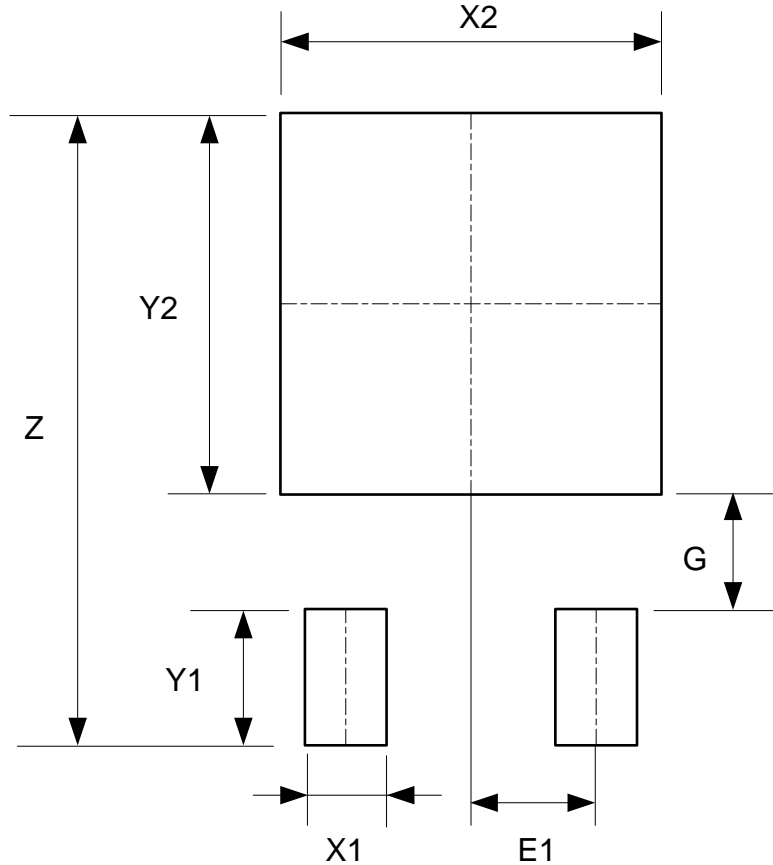

Dimensions	Z (mm)/(inch)	X1 (mm)/(inch)	X2=Y2 (mm)/(inch)	Y1 (mm)/(inch)	G (mm)/(inch)	E1 (mm)/(inch)
Value	11.600/0.457	1.500/0.059	7.000/0.276	2.500/0.098	2.100/0.083	2.300/0.091

Mechanical Data

- Moisture Sensitivity: Level 3 per J-STD-020
- Terminals: Finish— Matte Tin Plated Leads, Solderable per MIL-STD-202, Method 208 ③
- Weight:
 - TO252-2 (3)/(4)/(5) /TO252 (Type CJ): 0.312 grams (Approximate)
 - SOT-223: 0.116 grams (Approximate)
 - SOT89: 0.055 grams (Approximate)

IMPORTANT NOTICE

1. DIODES INCORPORATED (Diodes) AND ITS SUBSIDIARIES MAKE NO WARRANTY OF ANY KIND, EXPRESS OR IMPLIED, WITH REGARDS TO ANY INFORMATION CONTAINED IN THIS DOCUMENT, INCLUDING, BUT NOT LIMITED TO, THE IMPLIED WARRANTIES OF MERCHANTABILITY, FITNESS FOR A PARTICULAR PURPOSE OR NON-INFRINGEMENT OF THIRD PARTY INTELLECTUAL PROPERTY RIGHTS (AND THEIR EQUIVALENTS UNDER THE LAWS OF ANY JURISDICTION).
2. The Information contained herein is for informational purpose only and is provided only to illustrate the operation of Diodes' products described herein and application examples. Diodes does not assume any liability arising out of the application or use of this document or any product described herein. This document is intended for skilled and technically trained engineering customers and users who design with Diodes' products. Diodes' products may be used to facilitate safety-related applications; however, in all instances customers and users are responsible for (a) selecting the appropriate Diodes products for their applications, (b) evaluating the suitability of Diodes' products for their intended applications, (c) ensuring their applications, which incorporate Diodes' products, comply the applicable legal and regulatory requirements as well as safety and functional-safety related standards, and (d) ensuring they design with appropriate safeguards (including testing, validation, quality control techniques, redundancy, malfunction prevention, and appropriate treatment for aging degradation) to minimize the risks associated with their applications.
3. Diodes assumes no liability for any application-related information, support, assistance or feedback that may be provided by Diodes from time to time. Any customer or user of this document or products described herein will assume all risks and liabilities associated with such use, and will hold Diodes and all companies whose products are represented herein or on Diodes' websites, harmless against all damages and liabilities.
4. Products described herein may be covered by one or more United States, international or foreign patents and pending patent applications. Product names and markings noted herein may also be covered by one or more United States, international or foreign trademarks and trademark applications. Diodes does not convey any license under any of its intellectual property rights or the rights of any third parties (including third parties whose products and services may be described in this document or on Diodes' website) under this document.
5. Diodes' products are provided subject to Diodes' Standard Terms and Conditions of Sale (<https://www.diodes.com/about/company/terms-and-conditions/terms-and-conditions-of-sales/>) or other applicable terms. This document does not alter or expand the applicable warranties provided by Diodes. Diodes does not warrant or accept any liability whatsoever in respect of any products purchased through unauthorized sales channel.
6. Diodes' products and technology may not be used for or incorporated into any products or systems whose manufacture, use or sale is prohibited under any applicable laws and regulations. Should customers or users use Diodes' products in contravention of any applicable laws or regulations, or for any unintended or unauthorized application, customers and users will (a) be solely responsible for any damages, losses or penalties arising in connection therewith or as a result thereof, and (b) indemnify and hold Diodes and its representatives and agents harmless against any and all claims, damages, expenses, and attorney fees arising out of, directly or indirectly, any claim relating to any noncompliance with the applicable laws and regulations, as well as any unintended or unauthorized application.
7. While efforts have been made to ensure the information contained in this document is accurate, complete and current, it may contain technical inaccuracies, omissions and typographical errors. Diodes does not warrant that information contained in this document is error-free and Diodes is under no obligation to update or otherwise correct this information. Notwithstanding the foregoing, Diodes reserves the right to make modifications, enhancements, improvements, corrections or other changes without further notice to this document and any product described herein. This document is written in English but may be translated into multiple languages for reference. Only the English version of this document is the final and determinative format released by Diodes.
8. Any unauthorized copying, modification, distribution, transmission, display or other use of this document (or any portion hereof) is prohibited. Diodes assumes no responsibility for any losses incurred by the customers or users or any third parties arising from any such unauthorized use.
9. This Notice may be periodically updated with the most recent version available at <https://www.diodes.com/about/company/terms-and-conditions/important-notice>

DIODES is a trademark of Diodes Incorporated in the United States and other countries.
The Diodes logo is a registered trademark of Diodes Incorporated in the United States and other countries.
© 2022 Diodes Incorporated. All Rights Reserved.

www.diodes.com