

MOSFET – Dual, N-Channel, POWERTRENCH®

30 V, 10 mΩ, 20 mΩ

FDMC8200S

General Description

This device includes two specialized N-Channel MOSFETs in a dual Power33 (3 mm x 3 mm MLP) package. The switch node has been internally connected to enable easy placement and routing of synchronous buck converters. The control MOSFET (Q1) and synchronous MOSFET (Q2) have been designed to provide optimal power efficiency.

Features

- Q1: N-Channel
 - ◆ Max $r_{DS(on)}$ = 20 mΩ at $V_{GS} = 10\text{ V}$, $I_D = 6\text{ A}$
 - ◆ Max $r_{DS(on)}$ = 32 mΩ at $V_{GS} = 4.5\text{ V}$, $I_D = 5\text{ A}$
- Q2: N-Channel
 - ◆ Max $r_{DS(on)}$ = 10 mΩ at $V_{GS} = 10\text{ V}$, $I_D = 8.5\text{ A}$
 - ◆ Max $r_{DS(on)}$ = 13.5 mΩ at $V_{GS} = 4.5\text{ V}$, $I_D = 7.2\text{ A}$
- This Device is Pb-Free, Halide Free and is RoHS Compliant

Applications

- Mobile Computing
- Mobile Internet Devices
- General Purpose Point of Load

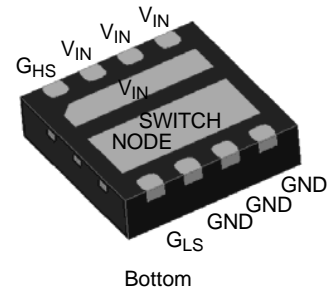
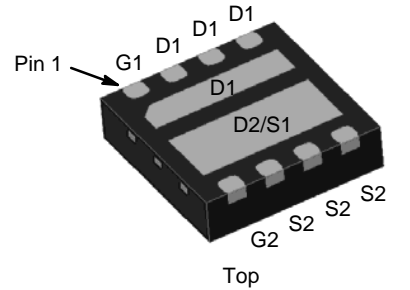

WDFN8 3x3, 0.65P
(Power 33)
CASE 511DE

MARKING DIAGRAM

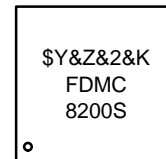

\$Y = Logo
&Z = Assembly Plant Code
&2 = 2-Digit Date Code
&K = 2-Digits Lot Run Traceability Code
FDMC8200S = Device Code

SCHEMATIC

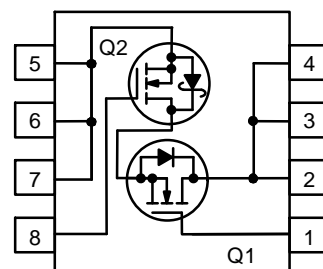

ORDERING INFORMATION

See detailed ordering and shipping information on page 10 of this data sheet.

FDMC8200S

MOSFET MAXIMUM RATINGS (T_C = 25°C, unless otherwise noted)

Symbol	Parameter	Q1	Q2	Unit
V _{DS}	Drain to Source Voltage	30	30	V
V _{GS}	Gate to Source Voltage (Note 4)	±20	±20	V
I _D	Drain Current – Continuous (Package Limited) T _C = 25°C	18	13	A
	– Continuous (Silicon Limited) T _C = 25°C	23	46	
	– Continuous T _A = 25°C	6 (Note 1a)	8.5 (Note 1b)	
	– Pulsed	40	27	
E _{AS}	Single Pulse Avalanche Energy (Note 3)	12	32	
P _D	Power Dissipation for Single Operation T _A = 25°C	1.9 (Note 1a)	2.5 (Note 1b)	W
	Power Dissipation for Single Operation T _A = 25°C	0.7 (Note 1c)	1.0 (Note 1d)	
T _J , T _{STG}	Operating and Storage Junction Temperature Range	–55 to +150		°C

Stresses exceeding those listed in the Maximum Ratings table may damage the device. If any of these limits are exceeded, device functionality should not be assumed, damage may occur and reliability may be affected.

THERMAL CHARACTERISTICS (T_C = 25°C, unless otherwise noted)

Symbol	Parameter	Q1	Q2	Unit
R _{θJA}	Thermal Resistance, Junction to Ambient	65 (Note 1a)	50 (Note 1b)	°C/W
R _{θJA}	Thermal Resistance, Junction to Ambient	180 (Note 1c)	125 (Note 1d)	
R _{θJC}	Thermal Resistance, Junction to Case	7.5	4.2	

ELECTRICAL CHARACTERISTICS (T_J = 25°C unless otherwise noted)

Symbol	Parameter	Test Conditions	Type	Min	Typ	Max	Unit
OFF CHARACTERISTICS							
BV _{DSS}	Drain to Source Breakdown Voltage	I _D = 250 μA, V _{GS} = 0 V I _D = 1 mA, V _{GS} = 0 V	Q1	30	–	–	V
			Q2	30	–	–	
$\frac{\Delta BV_{DSS}}{\Delta T_J}$	Breakdown Voltage Temperature Coefficient	I _D = 250 μA, referenced to 25°C I _D = 1 mA, referenced to 25°C	Q1	–	14	–	mV/°C
			Q2	–	13	–	
I _{DSS}	Zero Gate Voltage Drain Current	V _{DS} = 24 V, V _{GS} = 0 V	Q1	–	–	1	μA
			Q2	–	–	500	
I _{GSS}	Gate to Source Leakage Current	V _{GS} = ±20 V, V _{DS} = 0 V	Q1	–	–	100	nA
			Q2	–	–	100	

ON CHARACTERISTICS

V _{GS(th)}	Gate to Source Threshold Voltage	V _{GS} = V _{DS} , I _D = 250 μA V _{GS} = V _{DS} , I _D = 1 mA	Q1 Q2	1.0 1.0	2.3 2.0	3.0 3.0	V
$\frac{\Delta V_{GS(th)}}{\Delta T_J}$	Gate to Source Threshold Voltage Temperature Coefficient	I _D = 250 μA, referenced to 25°C I _D = 1 mA, referenced to 25°C	Q1	–	–5	–	mV/°C
			Q2	–	–6	–	
r _{DS(on)}	Static Drain to Source On Resistance	V _{GS} = 10 V, I _D = 6 A V _{GS} = 4.5 V, I _D = 5 A V _{GS} = 10 V, I _D = 6 A, T _J = 125°C	Q1	–	16	20	mΩ
				–	24	32	
			Q2	–	7.8	10.0	
				–	10.3	13.5	
g _{FS}	Forward Transconductance	V _{DD} = 5 V, I _D = 6 A V _{DD} = 5 V, I _D = 8.5 A	Q1	–	29	–	S
			Q2	–	43	–	

DYNAMIC CHARACTERISTICS

C _{iss}	Input Capacitance	V _{DS} = 15 V, V _{GS} = 0 V, f = 1 MHz	Q1	–	495	660	pF
			Q2	–	1080	1436	
C _{oss}	Output Capacitance		Q1	–	145	195	pF
			Q2	–	373	495	
C _{rss}	Reverse Transfer Capacitance		Q1	–	20	30	pF
			Q2	–	35	52	

FDMC8200S

ELECTRICAL CHARACTERISTICS (T_J = 25°C unless otherwise noted) (continued)

Symbol	Parameter	Test Conditions	Type	Min	Typ	Max	Unit
--------	-----------	-----------------	------	-----	-----	-----	------

DYNAMIC CHARACTERISTICS

R _g	Gate Resistance	f = 1 MHz	Q1	0.2	1.4	4.2	Ω
			Q2	0.2	1.2	3.6	

SWITCHING CHARACTERISTICS

t _{d(on)}	Turn-On Delay Time	Q1 V _{DD} = 15 V, I _D = 1 A, V _{GS} = 10 V, R _{GEN} = 6 Ω Q2 V _{DD} = 15 V, I _D = 1 A, V _{GS} = 10 V, R _{GEN} = 6 Ω	Q1	–	11	20	ns
t _r	Rise Time		Q1	–	3.1	10	
t _{d(off)}	Turn-Off Delay Time		Q2	–	1.8	10	
t _f	Fall Time		Q1	–	35	56	
			Q2	–	21	34	ns
			Q1	–	1.3	10	ns
			Q2	–	8.5	17	ns
Q _{g(TOT)}	Total Gate Charge	V _{GS} = 0 V to 10 V Q1 V _{DD} = 15 V, I _D = 6 A Q2 V _{DD} = 15 V, I _D = 8.5 A	Q1	–	7.3	10	nC
			Q2	–	15.7	22	
Q _{g(TOT)}	Total Gate Charge	V _{GS} = 0 V to 4.5 V Q1 V _{DD} = 15 V, I _D = 6 A Q2 V _{DD} = 15 V, I _D = 8.5 A	Q1	–	3.1	4.3	nC
			Q2	–	7.2	10	
Q _{gs}	Gate to Source Charge	Q1 V _{DD} = 15 V, I _D = 6 A	Q1	–	1.8	–	nC
			Q2	–	3	–	
Q _{gd}	Gate to Drain "Miller" Charge	Q2 V _{DD} = 15 V, I _D = 8.5 A	Q1	–	1	–	nC
			Q2	–	1.9	–	

DRAIN-SOURCE CHARACTERISTICS

V _{SD}	Source-Drain Diode Forward Voltage	V _{GS} = 0 V, I _S = 6 A (Note 2) V _{GS} = 0 V, I _S = 8.5 A (Note 2) V _{GS} = 0 V, I _S = 1.3 A (Note 2)	Q1	–	0.8	1.2	V
			Q2	–	0.8	1.2	
			Q2	–	0.6	0.8	
t _{rr}	Reverse Recovery Time	Q1 I _F = 6 A, di/dt = 100 A/μS	Q1	–	13	24	ns
			Q2	–	20	32	
Q _{rr}	Reverse Recovery Charge	Q2 I _F = 8.5 A, di/dt = 300 A/μS	Q1	–	2.3	10	nC
			Q2	–	15	24	

Product parametric performance is indicated in the Electrical Characteristics for the listed test conditions, unless otherwise noted. Product performance may not be indicated by the Electrical Characteristics if operated under different conditions.

- R_{θJA} is determined with the device mounted on a 1 in² pad 2 oz copper pad on a 1.5 x 1.5 in. board of FR-4 material. R_{θJC} is guaranteed by design while R_{θCA} is determined by the user's board design.

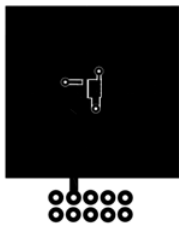

- 65°C/W when mounted on a 1 in² pad of 2 oz copper



- 50°C/W when mounted on a 1 in² pad of 2 oz copper

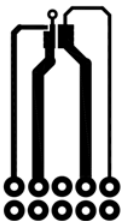

- 180°C/W when mounted on a minimum pad of 2 oz copper

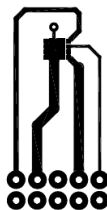

- 125°C/W when mounted on a minimum pad of 2 oz copper

- Pulse Test: Pulse Width < 300 μs, Duty cycle < 2.0%.
- Starting Q1: T = 25°C, L = 1 mH, I = 5 A, V_{gs} = 10 V, V_{dd} = 27 V, 100% test at L = 3 mH, I = 4 A; Q2: T = 25°C, L = 1 mH, I = 8 A, V_{gs} = 10 V, V_{dd} = 27 V, 100% test at L = 3 mH, I = 3.2 A.
- As an N-ch device, the negative V_{gs} rating is for low duty cycle pulse occurrence only. No continuous rating is implied.

TYPICAL CHARACTERISTICS (Q1 N-CHANNEL) ($T_J = 25^\circ\text{C}$, unless otherwise noted)

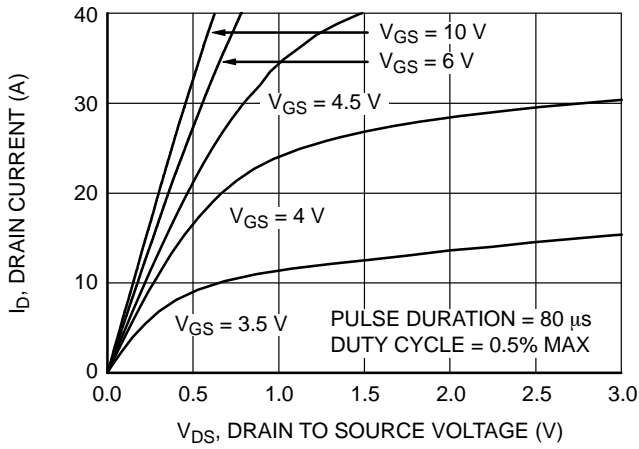

Figure 1. On Region Characteristics

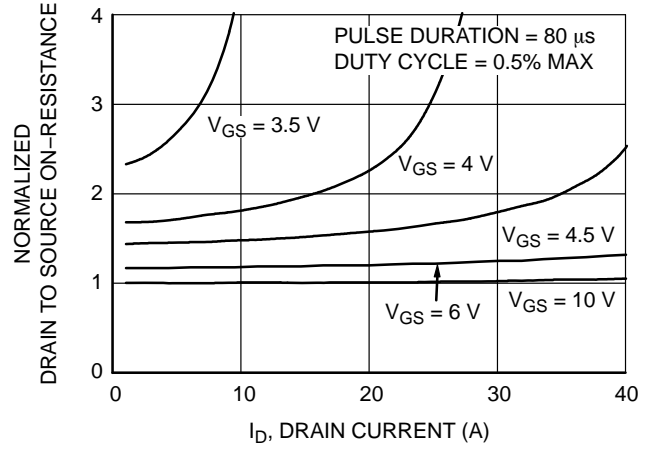

Figure 2. Normalized On-Resistance vs. Drain Current and Gate Voltage

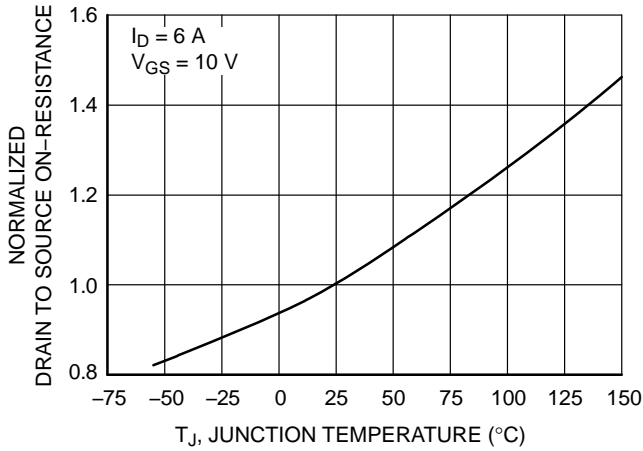

Figure 3. Normalized On Resistance vs. Junction Temperature

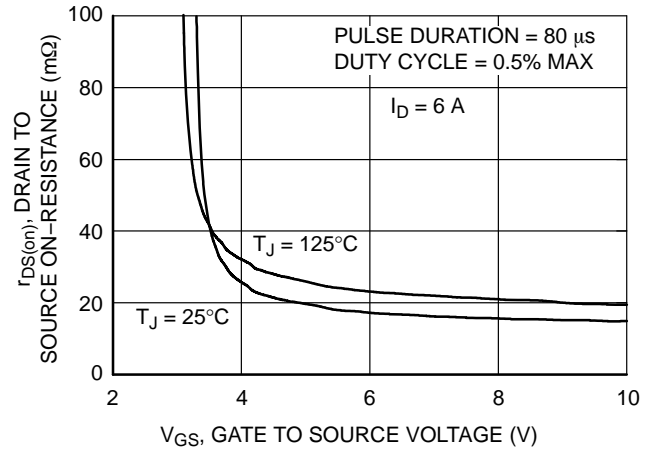

Figure 4. On-Resistance vs. Gate to Source Voltage

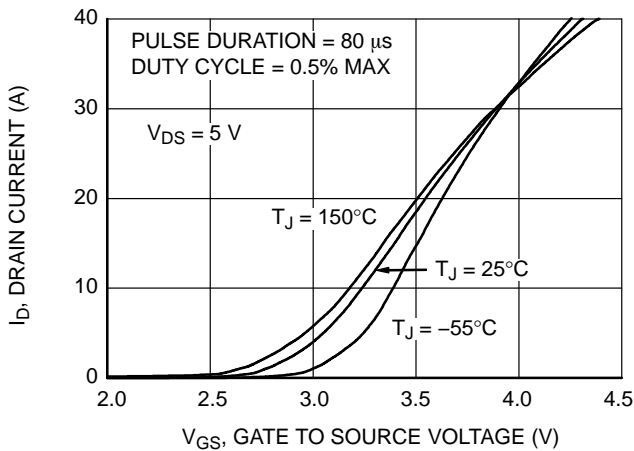

Figure 5. Transfer Characteristics

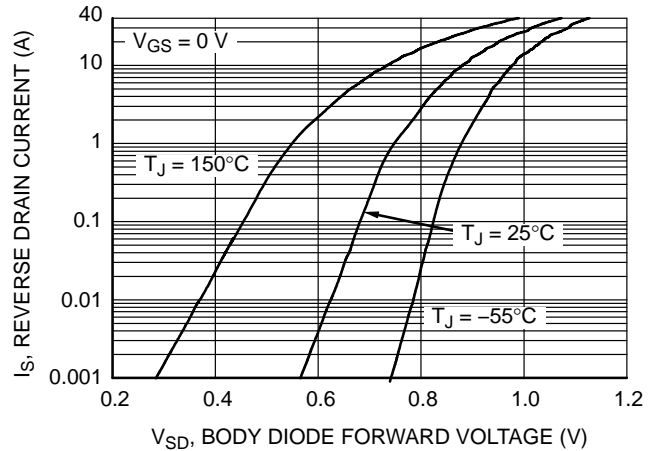

Figure 6. Source to Drain Diode Forward Voltage vs. Source Current

FDMC8200S

TYPICAL CHARACTERISTICS (Q1 N-CHANNEL) ($T_J = 25^\circ\text{C}$, unless otherwise noted) (continued)

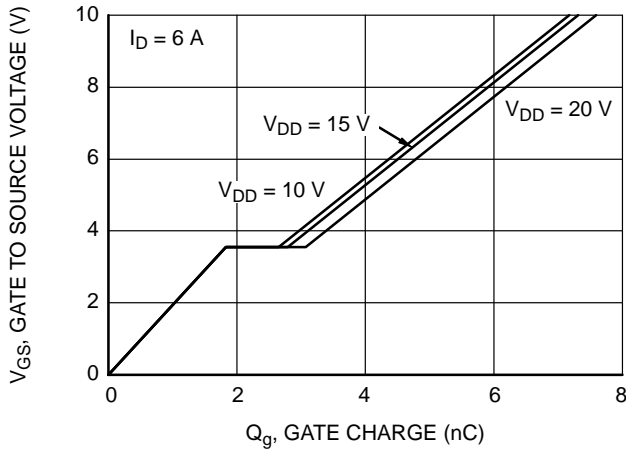

Figure 7. Gate Charge Characteristics

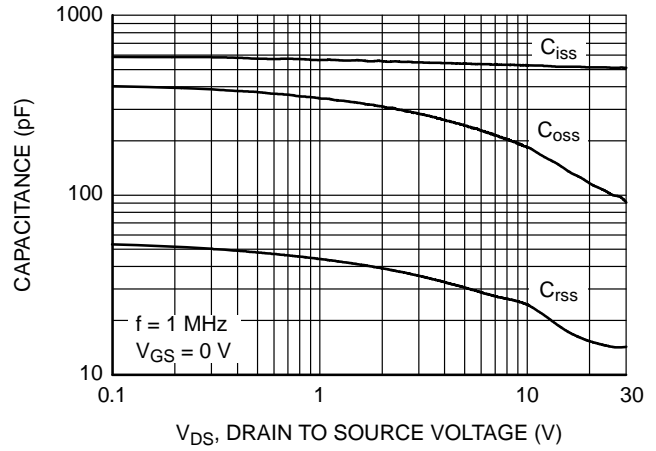

Figure 8. Capacitance vs. Drain to Source Voltage

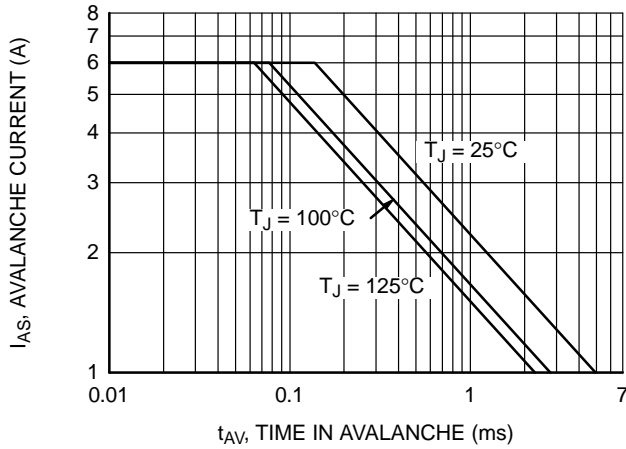

Figure 9. Unclamped Inductive Switching Capability

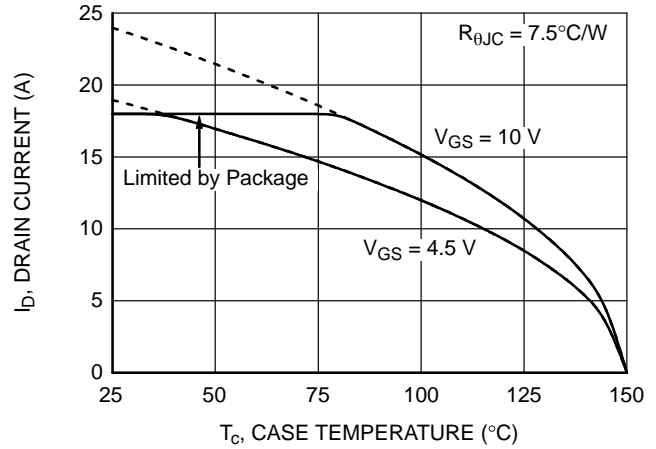

Figure 10. Maximum Continuous Drain Current vs. Case Temperature

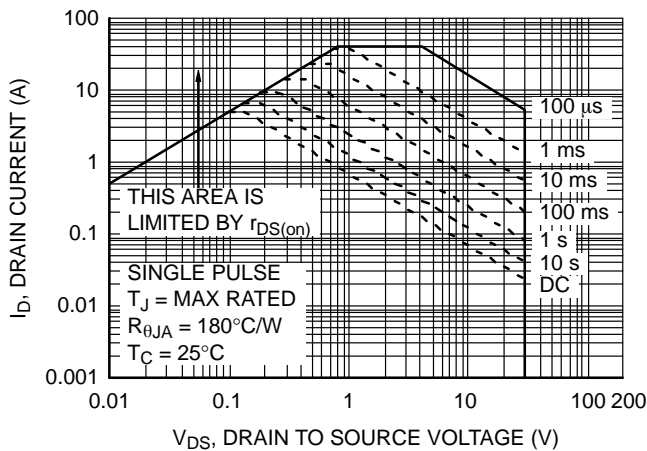

Figure 11. Forward Bias Safe Operating Area

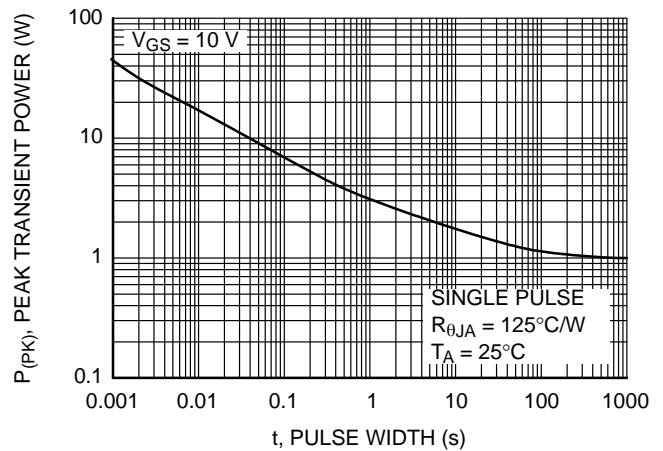

Figure 12. Single Pulse Maximum Power Dissipation

FDMC8200S

TYPICAL CHARACTERISTICS (Q1 N-CHANNEL) ($T_J = 25^\circ\text{C}$, unless otherwise noted) (continued)

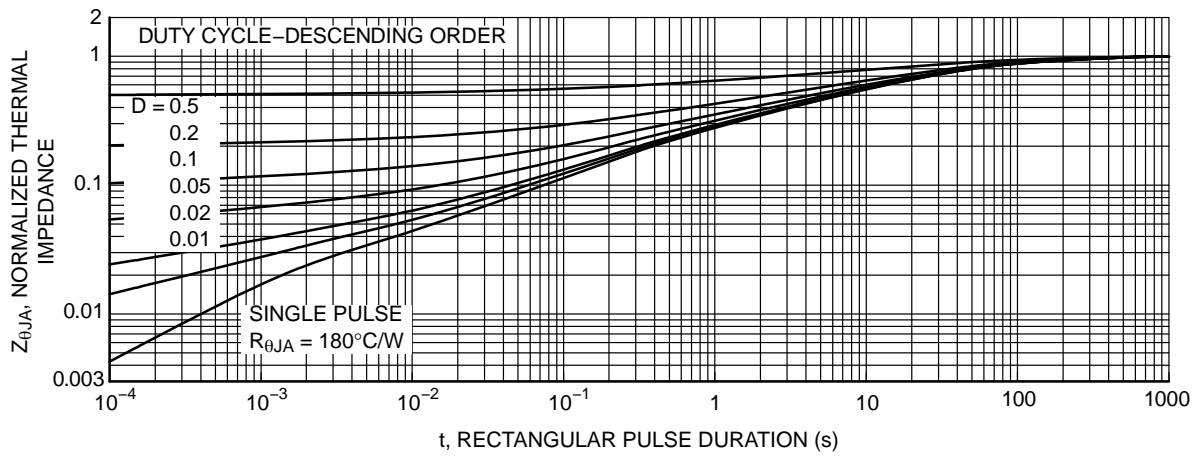

Figure 13. Junction-to-Ambient Transient Thermal Response Curve

TYPICAL CHARACTERISTICS (Q2 N-CHANNEL) ($T_J = 25^\circ\text{C}$, unless otherwise noted)

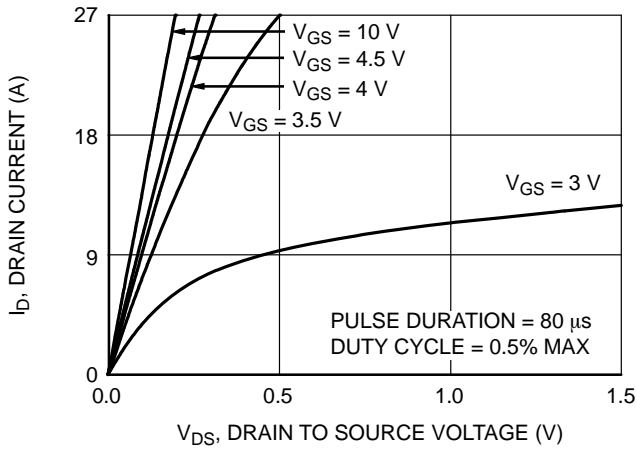

Figure 14. On-Region Characteristics

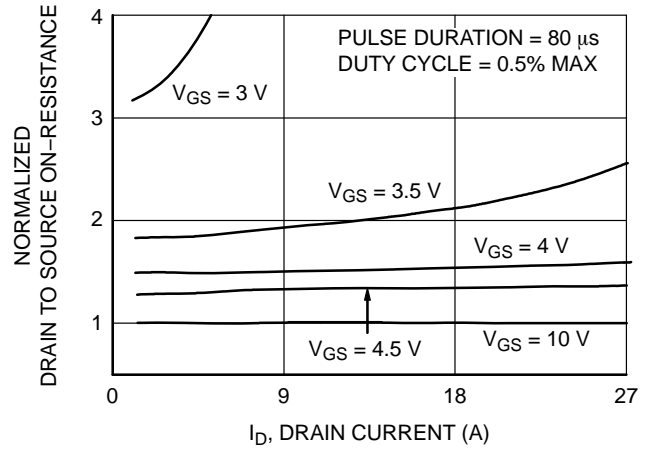

Figure 15. Normalized On-Resistance vs. Drain Current and Gate Voltage

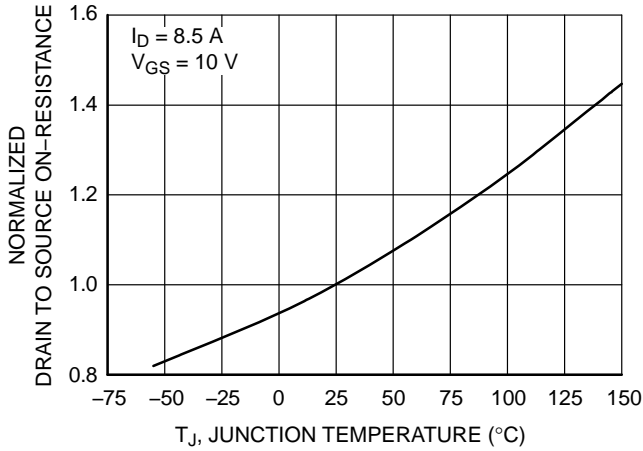

Figure 16. Normalized On-Resistance vs. Junction Temperature

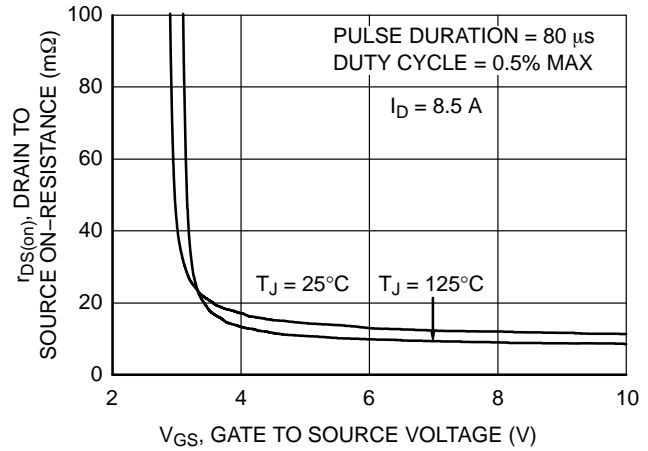

Figure 17. On-Resistance vs. Gate to Source Voltage

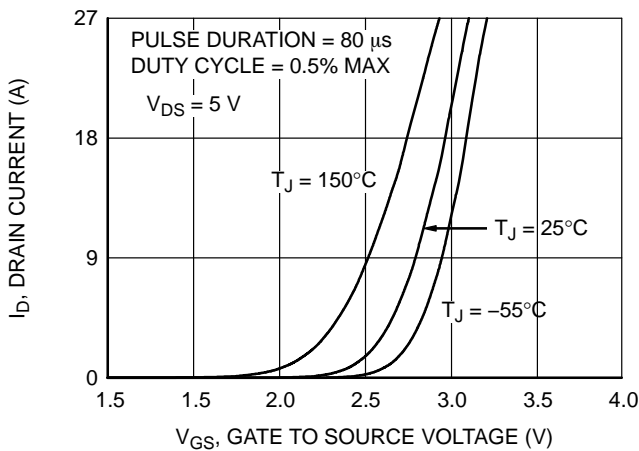

Figure 18. Transfer Characteristics

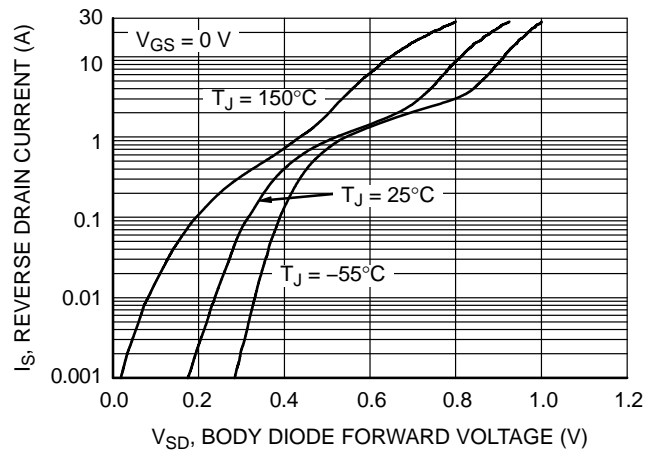

Figure 19. Source to Drain Diode Forward Voltage vs. Source Current

TYPICAL CHARACTERISTICS (Q2 N-CHANNEL) ($T_J = 25^\circ\text{C}$, unless otherwise noted) (continued)

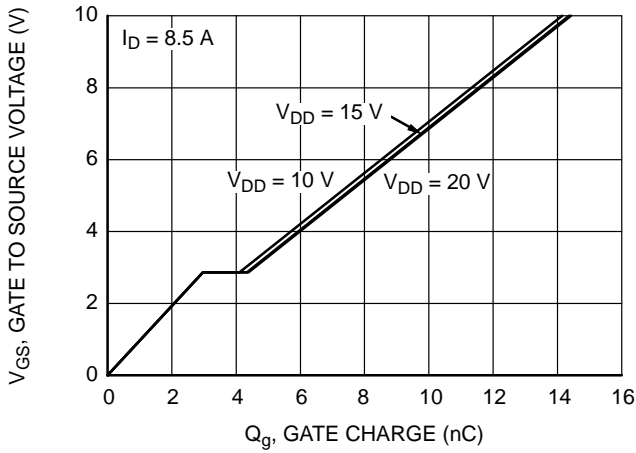

Figure 20. Gate Charge Characteristics

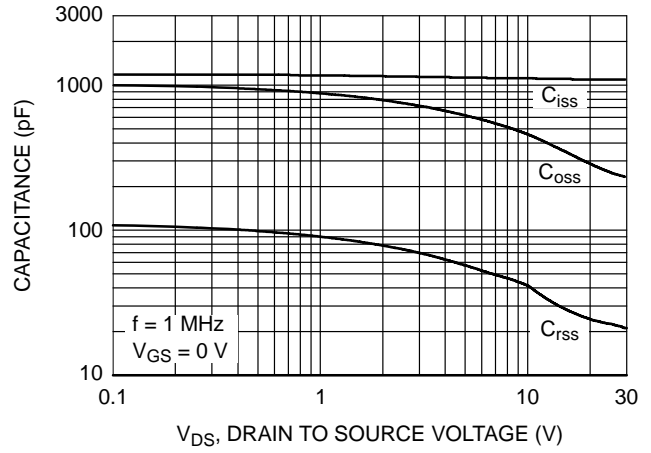

Figure 21. Capacitance vs. Drain to Source Voltage

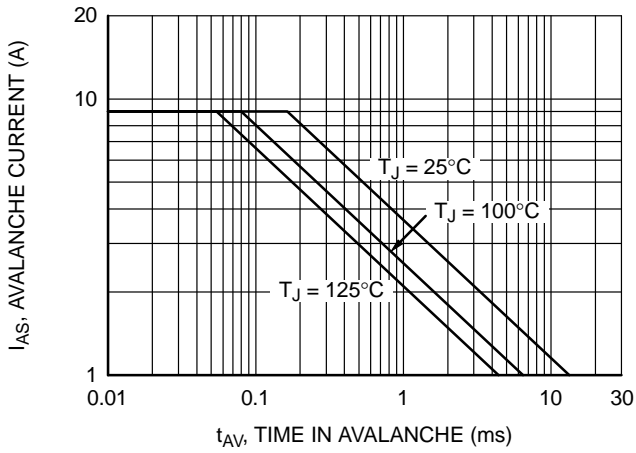

Figure 22. Unclamped Inductive Switching Capability

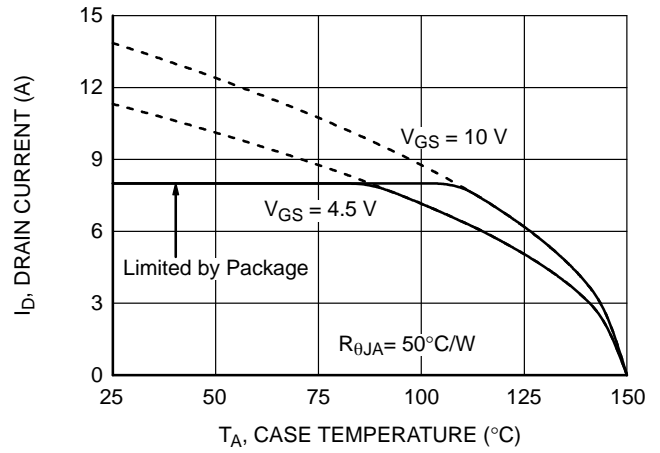

Figure 23. Maximum Continuous Drain Current vs. Case Temperature

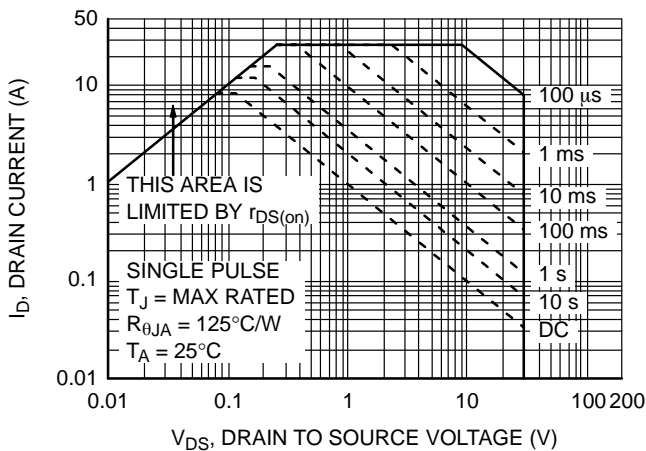

Figure 24. Forward Bias Safe Operating Area

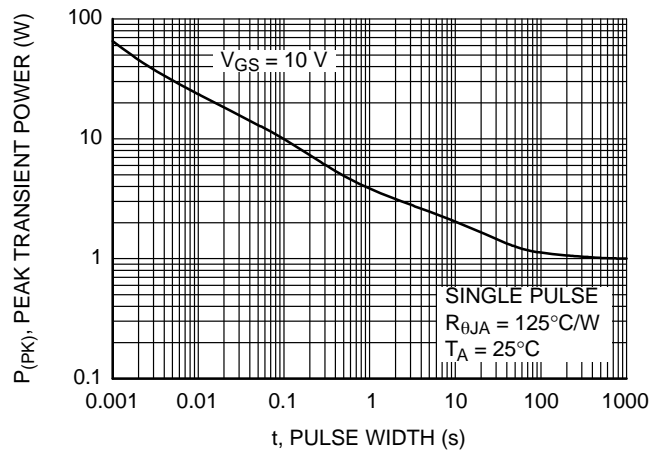

Figure 25. Single Pulse Maximum Power Dissipation

FDMC8200S

TYPICAL CHARACTERISTICS (Q2 N-CHANNEL) ($T_J = 25^\circ\text{C}$, unless otherwise noted) (continued)

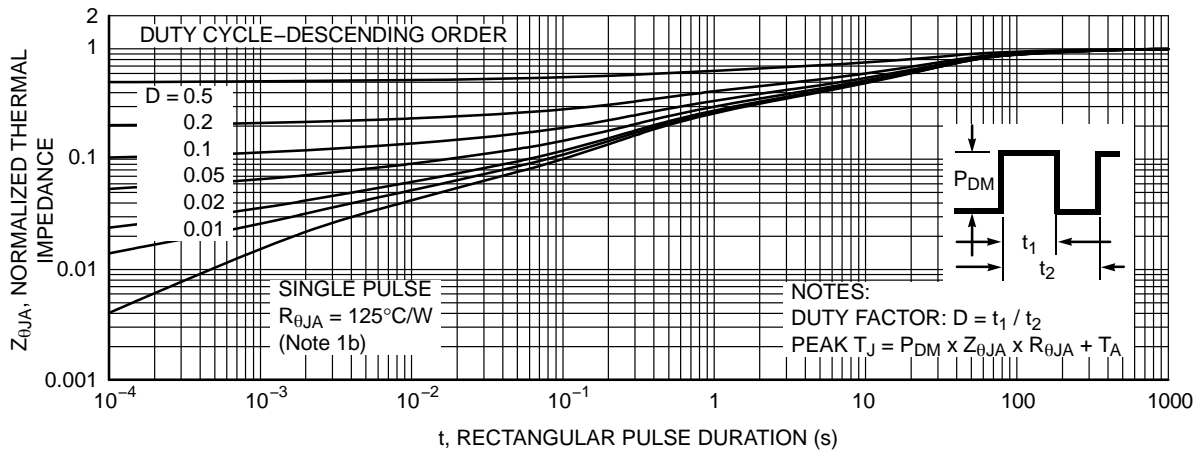

Figure 26. Junction-to-Ambient Transient Thermal Response Curve

FDMC8200S

TYPICAL CHARACTERISTICS (continued)

SyncFET Schottky Body Diode Characteristics

onsemi's SyncFET™ process embeds a Schottky diode in parallel with POWERTRENCH MOSFET. This diode exhibits similar characteristics to a discrete external Schottky diode in parallel with a MOSFET. Figure 14 shows the reverse recovery characteristic of the FDMC8200S.

Schottky barrier diodes exhibit significant leakage at high temperature and high reverse voltage. This will increase the power in the device.

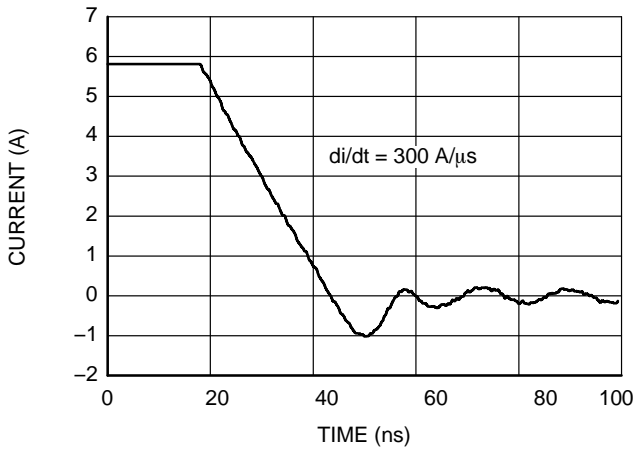

Figure 27. FDMC8200S SyncFET Body Diode Reverse Recovery Characteristic

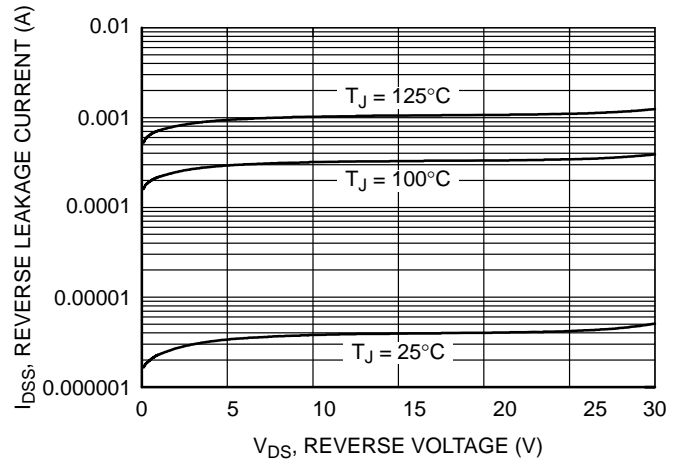

Figure 28. SyncFET Body Diode Reverse Leakage Versus Drain-Source Voltage

PACKAGE MARKING AND ORDERING INFORMATION

Device	Device Marking	Package	Reel Size	Tape Width	Shipping†
FDMC8200S	FDMC8200S	WDFN8 3x3, 0.65P (Power 33) (Pb-Free, Halide Free)	13"	12 mm	3000 / Tape & Reel

†For information on tape and reel specifications, including part orientation and tape sizes, please refer to our Tape and Reel Packaging Specifications Brochure, BRD8011/D.

POWERTRENCH is registered trademark of Semiconductor Components Industries, LLC dba "onsemi" or its affiliates and/or subsidiaries in the United States and/or other countries.

SyncFET is trademark of Semiconductor Components Industries, LLC dba "onsemi" or its affiliates and/or subsidiaries in the United States and/or other countries.

MECHANICAL CASE OUTLINE

PACKAGE DIMENSIONS

ON Semiconductor®



WDFN8 3x3, 0.65P
CASE 511DE
ISSUE O

DATE 31 AUG 2016

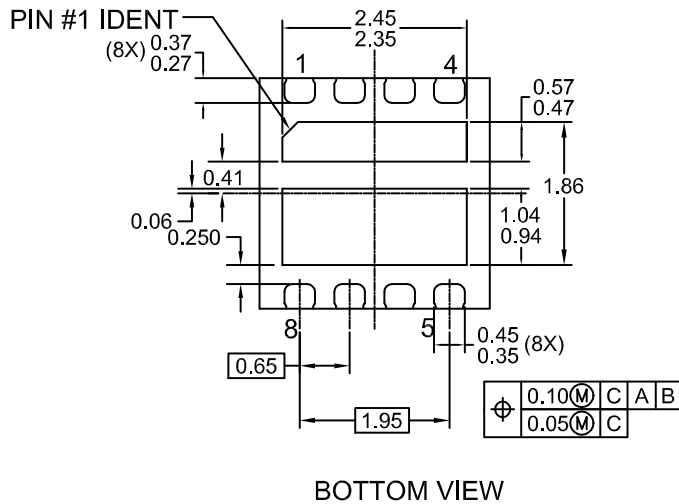
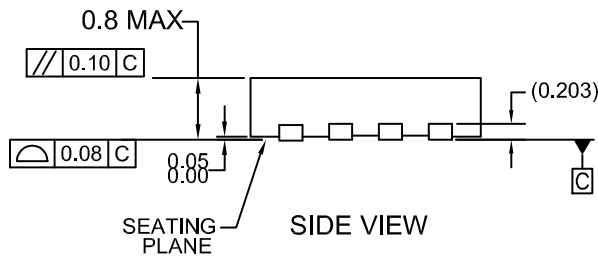
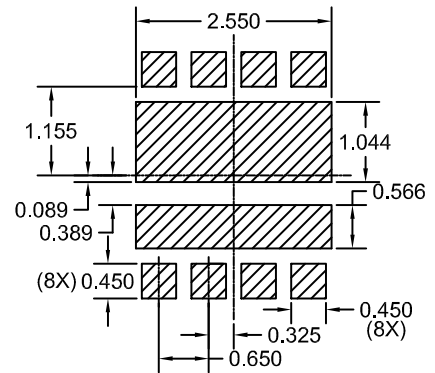
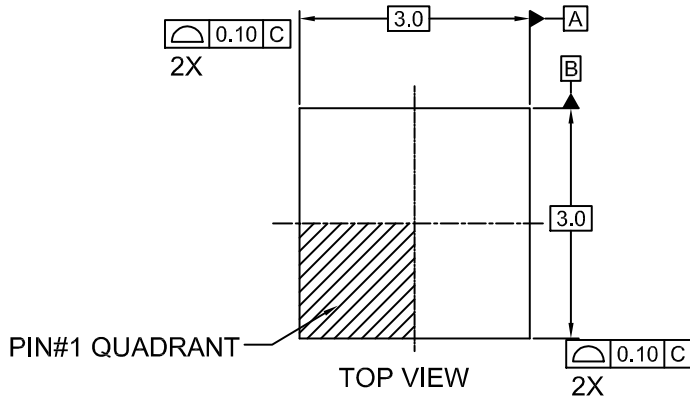

NOTES:

- A. DOES NOT CONFORM TO JEDEC REGISTRATION MO-229
- B. DIMENSIONS ARE IN MILLIMETERS.
- C. DIMENSIONS AND TOLERANCES PER ASME Y14.5M, 1994

DOCUMENT NUMBER:	98AON13621G	Electronic versions are uncontrolled except when accessed directly from the Document Repository. Printed versions are uncontrolled except when stamped "CONTROLLED COPY" in red.
DESCRIPTION:	WDFN8 3X3, 0.65P	PAGE 1 OF 1

ON Semiconductor and are trademarks of Semiconductor Components Industries, LLC dba ON Semiconductor or its subsidiaries in the United States and/or other countries. ON Semiconductor reserves the right to make changes without further notice to any products herein. ON Semiconductor makes no warranty, representation or guarantee regarding the suitability of its products for any particular purpose, nor does ON Semiconductor assume any liability arising out of the application or use of any product or circuit, and specifically disclaims any and all liability, including without limitation special, consequential or incidental damages. ON Semiconductor does not convey any license under its patent rights nor the rights of others.

onsemi, **Onsemi**, and other names, marks, and brands are registered and/or common law trademarks of Semiconductor Components Industries, LLC dba "**onsemi**" or its affiliates and/or subsidiaries in the United States and/or other countries. **onsemi** owns the rights to a number of patents, trademarks, copyrights, trade secrets, and other intellectual property. A listing of **onsemi**'s product/patent coverage may be accessed at www.onsemi.com/site/pdf/Patent-Marking.pdf. **onsemi** reserves the right to make changes at any time to any products or information herein, without notice. The information herein is provided "as-is" and **onsemi** makes no warranty, representation or guarantee regarding the accuracy of the information, product features, availability, functionality, or suitability of its products for any particular purpose, nor does **onsemi** assume any liability arising out of the application or use of any product or circuit, and specifically disclaims any and all liability, including without limitation special, consequential or incidental damages. Buyer is responsible for its products and applications using **onsemi** products, including compliance with all laws, regulations and safety requirements or standards, regardless of any support or applications information provided by **onsemi**. "Typical" parameters which may be provided in **onsemi** data sheets and/or specifications can and do vary in different applications and actual performance may vary over time. All operating parameters, including "Typicals" must be validated for each customer application by customer's technical experts. **onsemi** does not convey any license under any of its intellectual property rights nor the rights of others. **onsemi** products are not designed, intended, or authorized for use as a critical component in life support systems or any FDA Class 3 medical devices or medical devices with a same or similar classification in a foreign jurisdiction or any devices intended for implantation in the human body. Should Buyer purchase or use **onsemi** products for any such unintended or unauthorized application, Buyer shall indemnify and hold **onsemi** and its officers, employees, subsidiaries, affiliates, and distributors harmless against all claims, costs, damages, and expenses, and reasonable attorney fees arising out of, directly or indirectly, any claim of personal injury or death associated with such unintended or unauthorized use, even if such claim alleges that **onsemi** was negligent regarding the design or manufacture of the part. **onsemi** is an Equal Opportunity/Affirmative Action Employer. This literature is subject to all applicable copyright laws and is not for resale in any manner.

ADDITIONAL INFORMATION

TECHNICAL PUBLICATIONS:

Technical Library: www.onsemi.com/design/resources/technical-documentation
onsemi Website: www.onsemi.com

ONLINE SUPPORT: www.onsemi.com/support

For additional information, please contact your local Sales Representative at www.onsemi.com/support/sales