

SECTION Y-Y  
SCALE 8:1

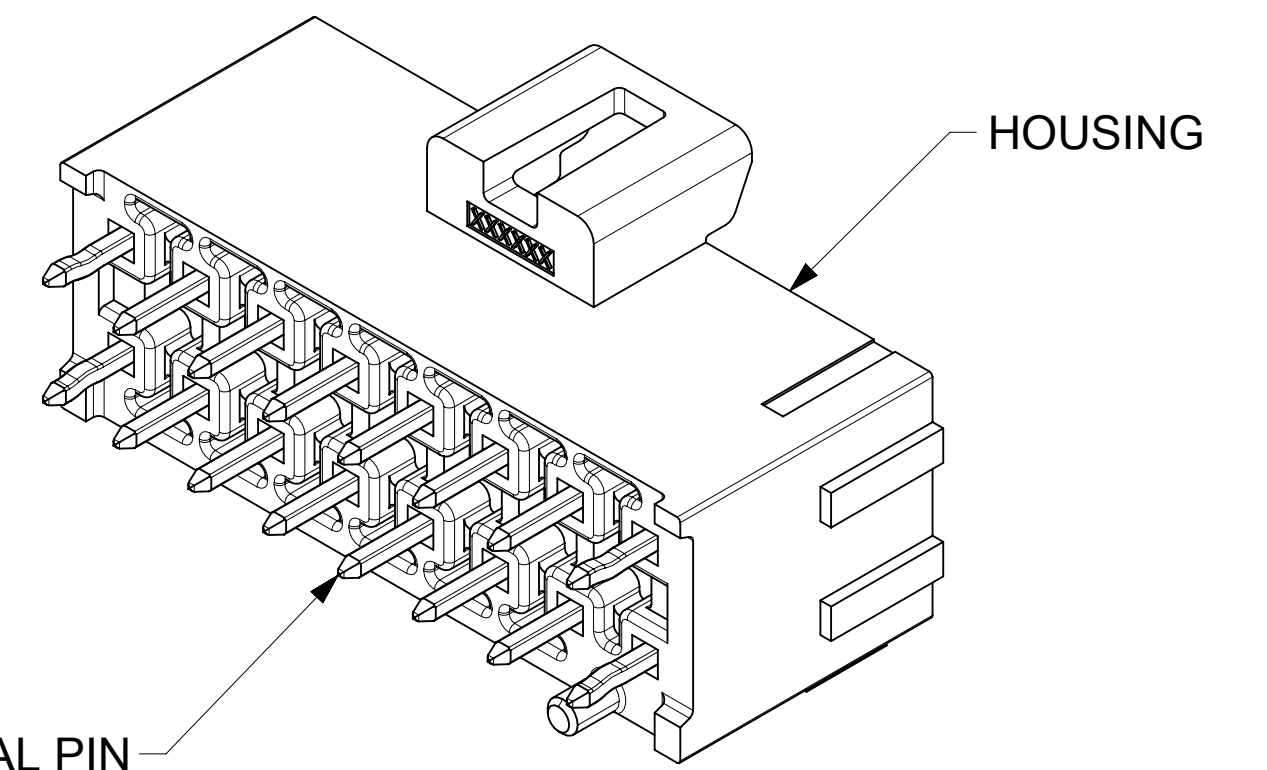

NOTES:

- MATERIAL :  
HOUSING  
OPTION 1: LCP BLACK, UL94 V-0  
OPTION 2: LCP NATURAL, UL94 V-0  
TERMINAL: COPPER ALLOY
- PLATING FINISH:  
OPTION 1 - 1.52µm(60µin)-2.54µm(100µin) TIN OVER,  
1.27µm(50µin)-2.54µm(100µin) NICKEL OVERALL,  
OPTION 2 - 0.38µm(15µin) GOLD CONTACT AREA,  
1.52µm(60µin)-2.54µm(100µin) TIN TAIL AREA OVER,  
1.27µm(50µin)-2.54µm(100µin) NICKEL OVERALL.  
OPTION 3 - 0.76µm(30µin) GOLD CONTACT AREA,  
1.52µm(60µin)-2.54µm(100µin) TIN TAIL AREA OVER,  
1.27µm(50µin)-2.54µm(100µin) NICKEL OVERALL.
- PACKAGE SPECIFICATION REFER TO CHART IN SHEET 3.
- PRODUCT SPECIFICATION PS-172323-0001.
- PART MATES WITH MOLEX RECEPTACLE HOUSING 172258 AND 172262.
- PART CONFORMS TO CLASS "C" REQUIREMENTS OF SPECIFICATION PS-45499-002 WITH 0.13 MM MAXIMUM FLASH ALLOWED IN CORE HOLES AND FRONT SURFACE.
- DISCOLORATION IN THE BANDOLIER AREA OF THE PIN IS INHERENT TO THE PLATING PROCESS AND IS DUE TO THE MASKING EFFECT OF THE CARRIER. THIS DISCOLORATION IS IN A NON-FUNCTIONAL AREA OF THE PIN AND WILL NOT AFFECT THE PERFORMANCE OF THE HEADER ASSEMBLY.
- APPLICATION SPECIFICATION: AS-172323-0001

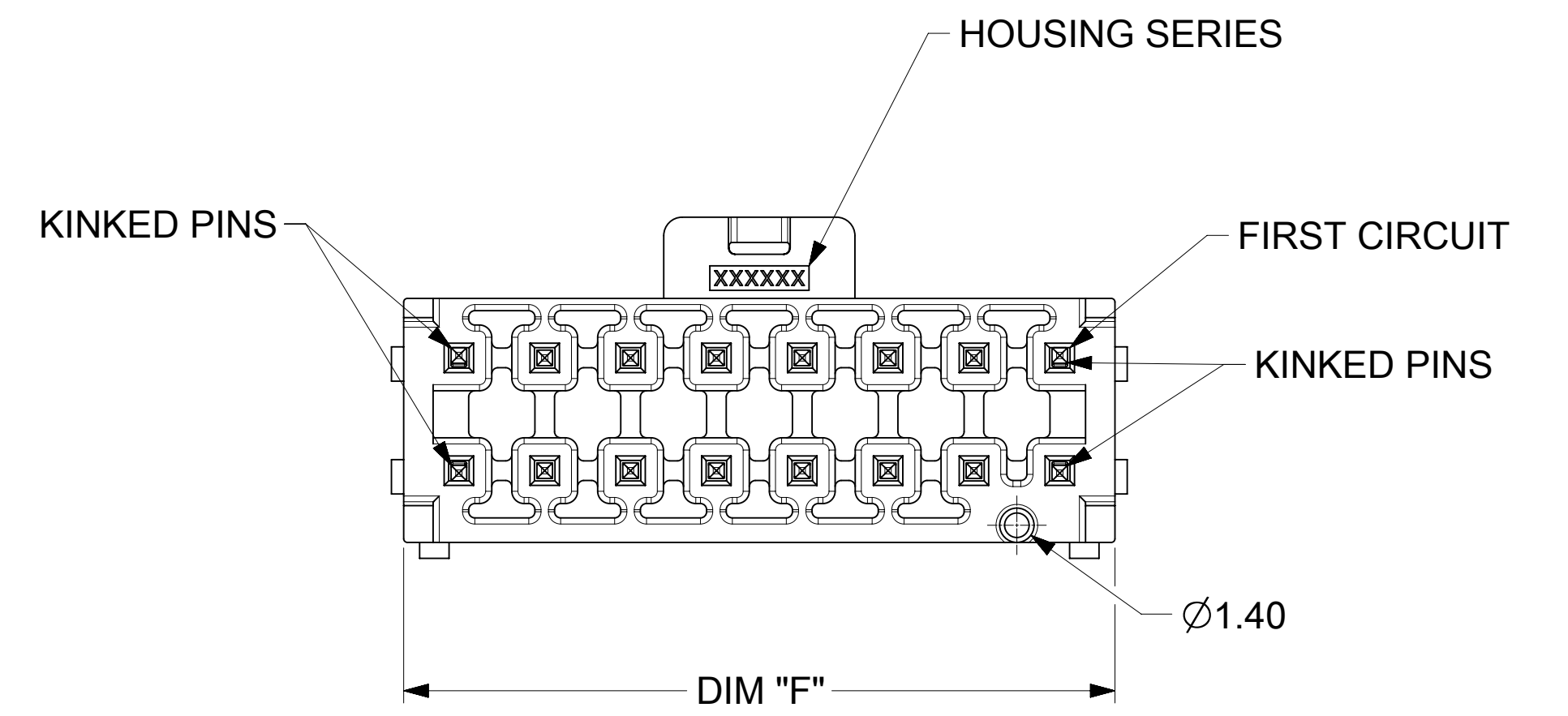
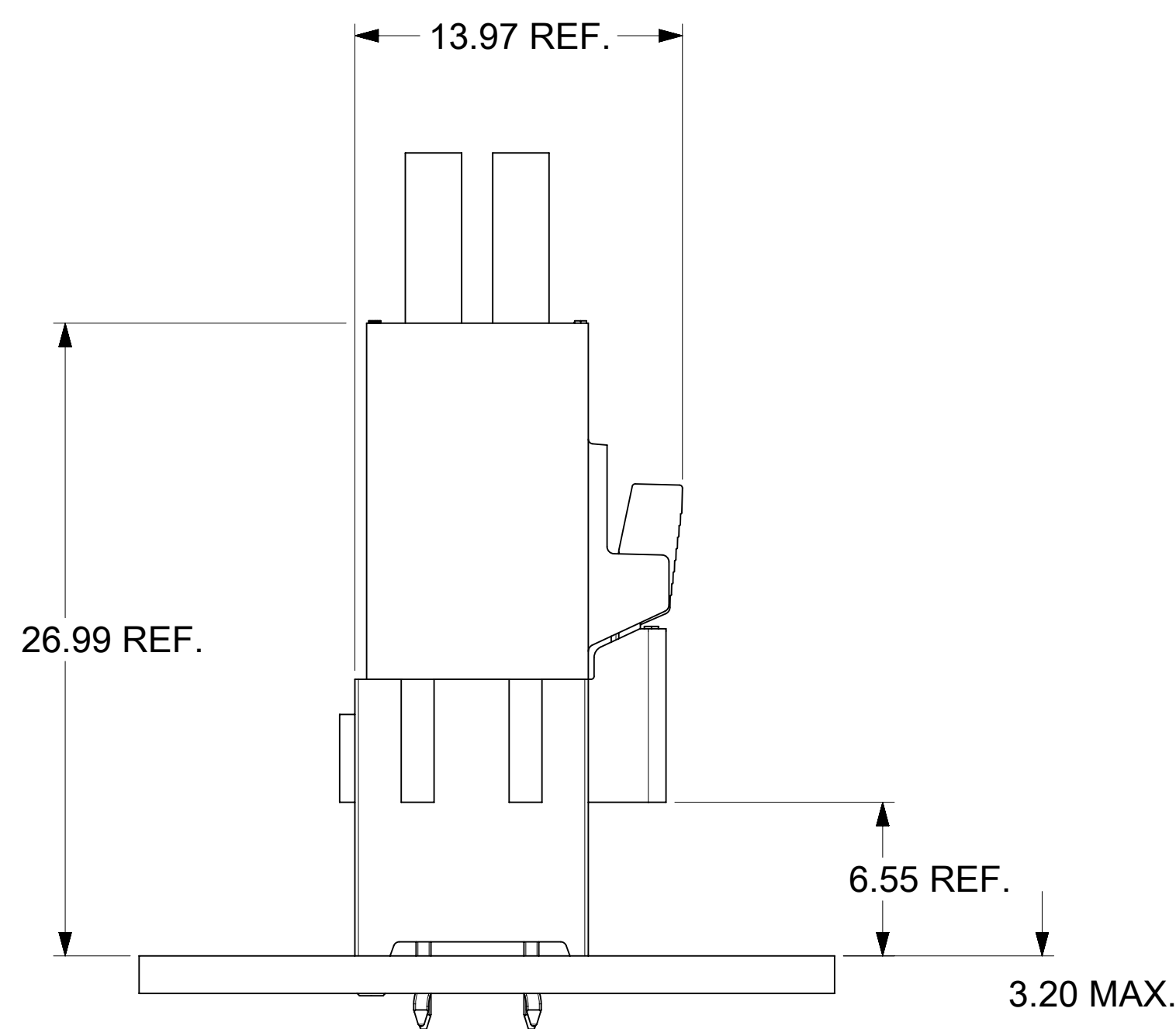

SYMBOLS	THIS DRAWING CONTAINS INFORMATION THAT IS PROPRIETARY TO MOLEX ELECTRONIC TECHNOLOGIES, LLC AND SHOULD NOT BE USED WITHOUT WRITTEN PERMISSION		
	DIMENSION UNITS	SCALE	CURRENT REV DESC:
▽ = 0	mm	4:1	
▽ = 0	GENERAL TOLERANCES (UNLESS SPECIFIED)		
▽ = 0	ANGULAR TOL	± °	
▽ = 0	4 PLACES	±	
▽ = 0	3 PLACES	±	
▽ = 0	2 PLACES	± 0.25	
▽ = 0	1 PLACE	± 0.5	
▽ = 0	0 PLACES	±	
■ = 0	DRAFT WHERE APPLICABLE MUST REMAIN WITHIN DIMENSIONS		
▽ = 0	THIRD ANGLE PROJECTION	DRAWING	SERIES
		D-SIZE	172298
	EC NO: 653772	2021/01/05	
	DRWN: GLLI	2021/02/14	
	CHK'D: YXZHENG	2021/02/14	
	APPR: YXZHENG	2021/02/14	
	INITIAL REVISION:		
	DRWN: DROSCA	2015/04/14	
	APPR: RHODGE	2016/04/05	
	DOCUMENT NUMBER	DOC TYPE	DOC PART
	SD-172298-1000	PSD	000
	REVISION		
	C2		
	MATERIAL NUMBER	CUSTOMER	SHEET NUMBER
		GENERAL MARKET	1 OF 3

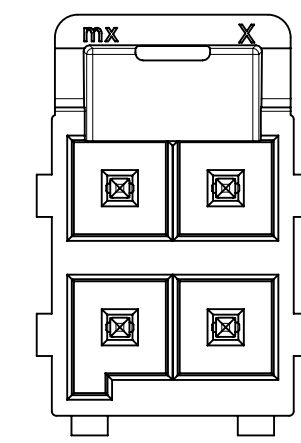

4 CKT

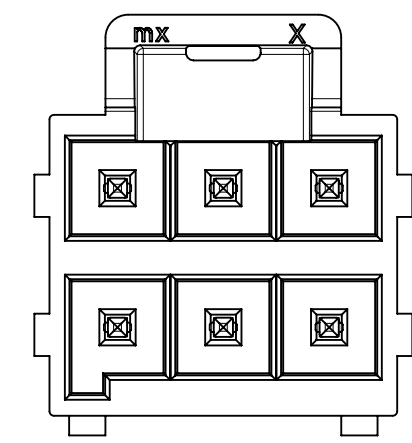

6 CKT

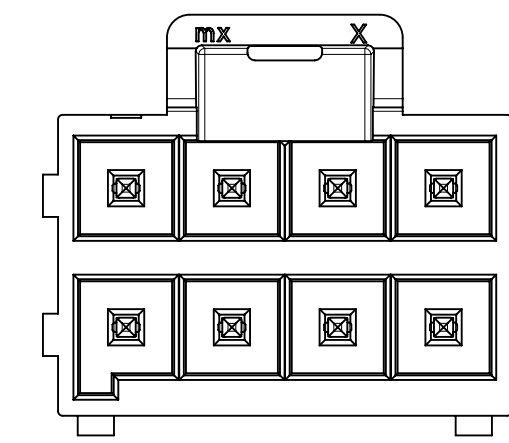

8 CKT

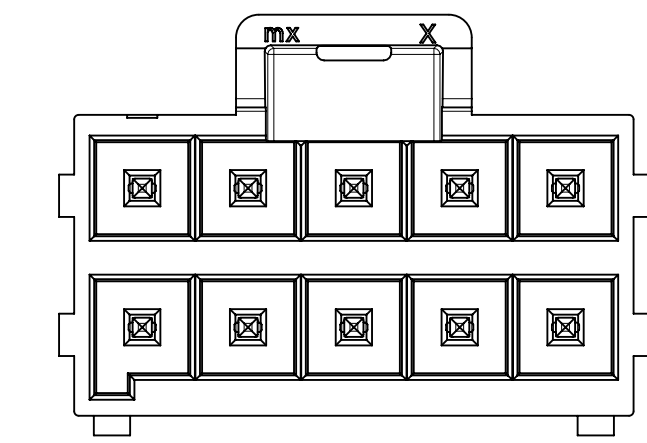

10 CKT

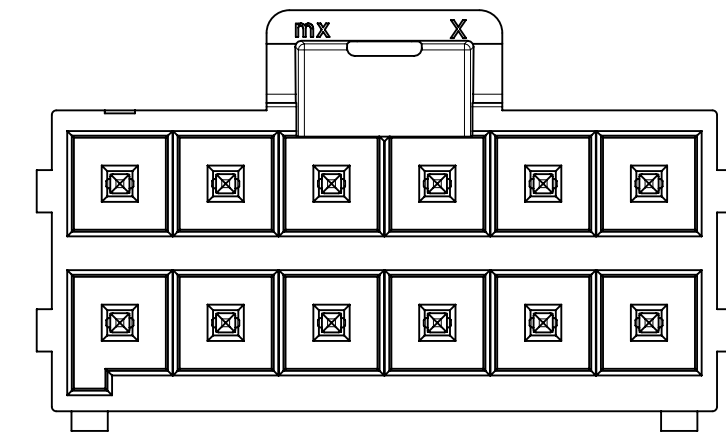

12 CKT

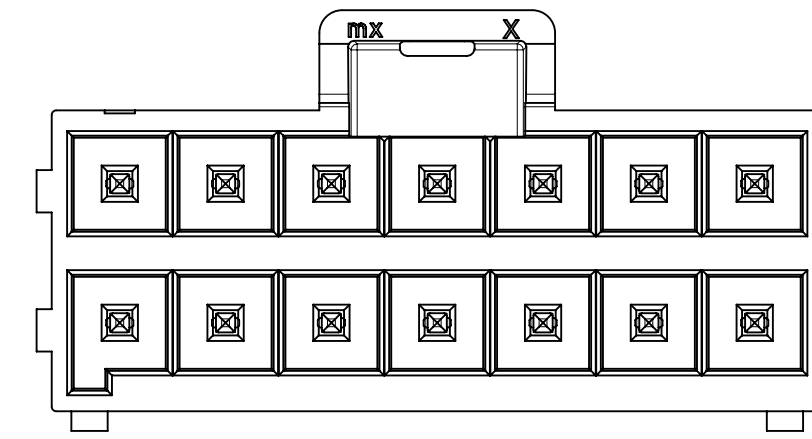

14 CKT

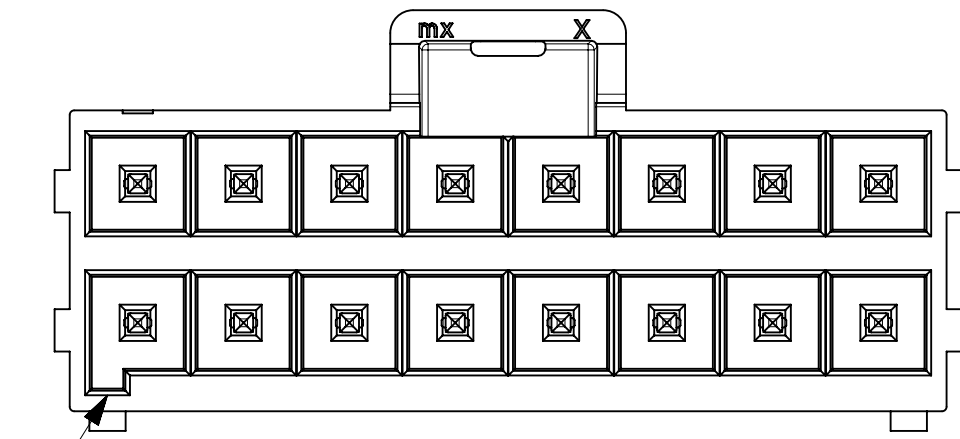

KEY A  
(BLACK)

16 CKT

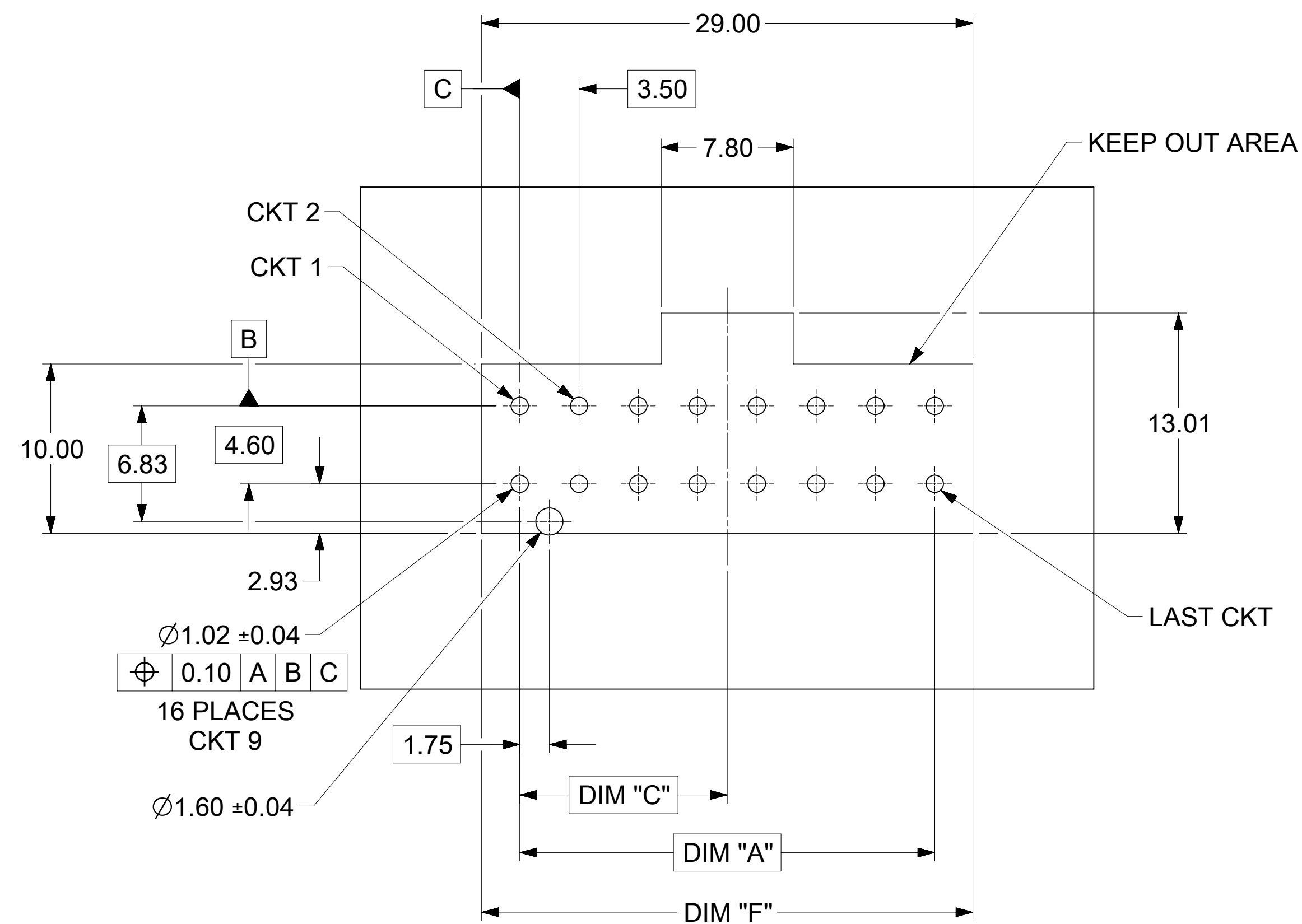

NOTE: DATUM -A- IS ON PCB COMPONENT SIDE

COLOR OPTION	 BLACK	 NATURAL
KAPTON OPTION	 WITHOUT KAPTON	 WITH KAPTON

SYMBOLS	THIS DRAWING CONTAINS INFORMATION THAT IS PROPRIETARY TO MOLEX ELECTRONIC TECHNOLOGIES, LLC AND SHOULD NOT BE USED WITHOUT WRITTEN PERMISSION		CURRENT REV DESC:		<b>molex</b>
	DIMENSION UNITS	SCALE			
▽ = 0	mm	4:1			ULTRA-FIT VERT HEADER 4-16 CKTS DUAL ROW KINKED PINS
▽ = 0	GENERAL TOLERANCES (UNLESS SPECIFIED)				PRODUCT CUSTOMER DRAWING
▽ = 0	ANGULAR TOL ± °				DOCUMENT NUMBER
▽ = 0	4 PLACES ±		EC NO: 653772	2021/01/05	DOC TYPE
▽ = 0	3 PLACES ±		DRWN: GLLI	2021/02/14	DOC PART
▽ = 0	2 PLACES ±	0.25	CHK'D: YXZHENG	2021/02/14	REVISION
▽ = 0	1 PLACE ±	0.5	APPR: YXZHENG		
⊠ = 0	0 PLACES ±		INITIAL REVISION:		
■ = 0	DRAFT WHERE APPLICABLE MUST REMAIN WITHIN DIMENSIONS		DRWN: DROSCA	2015/04/14	
▽ = 0	THIRD ANGLE PROJECTION		APPR: RHODGE	2016/04/05	
	DRAWING	SERIES	MATERIAL NUMBER		CUSTOMER
	D-SIZE	172298	SD-172298-1000		GENERAL MARKET
	SHEET NUMBER		2 OF 3		

TIN PLATING								COLOR	PACKAGING SPEC.
PART NO.	KAPTON OPTION	CIRCUIT SIZE	KEY OPTION	DIM A	DIM F	DIM C			
172298-1104	WITHOUT	4	KEY A	3.50	8.00	1.75	BLACK	TRAY PK-172298-9001	
172298-1106	WITHOUT	6	KEY A	7.00	11.50	3.50			
172298-1108	WITHOUT	8	KEY A	10.50	15.00	5.25			
172298-1110	WITHOUT	10	KEY A	14.00	18.50	7.00			
172298-1112	WITHOUT	12	KEY A	17.50	22.00	8.75			
172298-1114	WITHOUT	14	KEY A	21.00	25.50	10.50			
172298-1116	WITHOUT	16	KEY A	24.50	29.00	12.25			
172298-2104	WITHOUT	4	KEY B	3.50	8.00	1.75			
172298-2106	WITHOUT	6	KEY B	7.00	11.50	3.50			
172298-2108	WITHOUT	8	KEY B	10.50	15.00	5.25			
172298-2110	WITHOUT	10	KEY B	14.00	18.50	7.00			
172298-2112	WITHOUT	12	KEY B	17.50	22.00	8.75			
172298-2114	WITHOUT	14	KEY B	21.00	25.50	10.50			
172298-2116	WITHOUT	16	KEY B	24.50	29.00	12.25			
172298-7104	WITH	4	KEY A	3.50	8.00	1.75			
172298-7106	WITH	6	KEY A	7.00	11.50	3.50			
172298-7108	WITH	8	KEY A	10.50	15.00	5.25			
172298-7110	WITH	10	KEY A	14.00	18.50	7.00			
172298-7112	WITH	12	KEY A	17.50	22.00	8.75			
172298-7114	WITH	14	KEY A	21.00	25.50	10.50			
172298-7116	WITH	16	KEY A	24.50	29.00	12.25			
172298-8104	WITHOUT	4	KEY A	3.50	8.00	1.75			
172298-8106	WITHOUT	6	KEY A	7.00	11.50	3.50			
172298-8108	WITHOUT	8	KEY A	10.50	15.00	5.25			
172298-8110	WITHOUT	10	KEY A	14.00	18.50	7.00			
172298-8112	WITHOUT	12	KEY A	17.50	22.00	8.75			
172298-8114	WITHOUT	14	KEY A	21.00	25.50	10.50			
172298-8116	WITHOUT	16	KEY A	24.50	29.00	12.25			
172298-3104	WITH	4	KEY B	3.50	8.00	1.75			
172298-3106	WITH	6	KEY B	7.00	11.50	3.50			
172298-3108	WITH	8	KEY B	10.50	15.00	5.25			
172298-3110	WITH	10	KEY B	14.00	18.50	7.00			
172298-3112	WITH	12	KEY B	17.50	22.00	8.75			
172298-3114	WITH	14	KEY B	21.00	25.50	10.50			
172298-3116	WITH	16	KEY B	24.50	29.00	12.25			
172298-4104	WITHOUT	4	KEY B	3.50	8.00	1.75			
172298-4106	WITHOUT	6	KEY B	7.00	11.50	3.50			
172298-4108	WITHOUT	8	KEY B	10.50	15.00	5.25			
172298-4110	WITHOUT	10	KEY B	14.00	18.50	7.00			
172298-4112	WITHOUT	12	KEY B	17.50	22.00	8.75			
172298-4114	WITHOUT	14	KEY B	21.00	25.50	10.50			
172298-4116	WITHOUT	16	KEY B	24.50	29.00	12.25			

15 MICROINCH GOLD PLATING								COLOR	PACKAGING SPEC.
PART NO.	KAPTON OPTION	CIRCUIT SIZE	KEY OPTION	DIM A	DIM F	DIM C			
172298-1204	WITHOUT	4	KEY A	3.50	8.00	1.75	BLACK	TRAY PK-172298-9001	
172298-1206	WITHOUT	6	KEY A	7.00	11.50	3.50			
172298-1208	WITHOUT	8	KEY A	10.50	15.00	5.25			
172298-1210	WITHOUT	10	KEY A	14.00	18.50	7.00			
172298-1212	WITHOUT	12	KEY A	17.50	22.00	8.75			
172298-1214	WITHOUT	14	KEY A	21.00	25.50	10.50			
172298-1216	WITHOUT	16	KEY A	24.50	29.00	12.25			
172298-2204	WITHOUT	4	KEY B	3.50	8.00	1.75			
172298-2206	WITHOUT	6	KEY B	7.00	11.50	3.50			
172298-2208	WITHOUT	8	KEY B	10.50	15.00	5.25			
172298-2210	WITHOUT	10	KEY B	14.00	18.50	7.00			
172298-2212	WITHOUT	12	KEY B	17.50	22.00	8.75			
172298-2214	WITHOUT	14	KEY B	21.00	25.50	10.50			
172298-2216	WITHOUT	16	KEY B	24.50	29.00	12.25			
172298-7204	WITH	4	KEY A	3.50	8.00	1.75			
172298-7206	WITH	6	KEY A	7.00	11.50	3.50			
172298-7208	WITH	8	KEY A	10.50	15.00	5.25			
172298-7210	WITH	10	KEY A	14.00	18.50	7.00			
172298-7212	WITH	12	KEY A	17.50	22.00	8.75			
172298-7214	WITH	14	KEY A	21.00	25.50	10.50			
172298-7216	WITH	16	KEY A	24.50	29.00	12.25			
172298-8204	WITHOUT	4	KEY A	3.50	8.00	1.75			
172298-8206	WITHOUT	6	KEY A	7.00	11.50	3.50			
172298-8208	WITHOUT	8	KEY A	10.50	15.00	5.25			
172298-8210	WITHOUT	10	KEY A	14.00	18.50	7.00			
172298-8212	WITHOUT	12	KEY A	17.50	22.00	8.75			
172298-8214	WITHOUT	14	KEY A	21.00	25.50	10.50			
172298-8216	WITHOUT	16	KEY A	24.50	29.00	12.25			
172298-3204	WITH	4	KEY B	3.50	8.00	1.75			
172298-3206	WITH	6	KEY B	7.00	11.50	3.50			
172298-3208	WITH	8	KEY B	10.50	15.00	5.25			
172298-3210	WITH	10	KEY B	14.00	18.50	7.00			
172298-3212	WITH	12	KEY B	17.50	22.00	8.75			
172298-3214	WITH	14	KEY B	21.00	25.50	10.50			
172298-3216	WITH	16	KEY B	24.50	29.00	12.25			
172298-4204	WITHOUT	4	KEY B	3.50	8.00	1.75			
172298-4206	WITHOUT	6	KEY B	7.00	11.50	3.50			
172298-4208	WITHOUT	8	KEY B	10.50	15.00	5.25			
172298-4210	WITHOUT	10	KEY B	14.00	18.50	7.00			
172298-4212	WITHOUT	12	KEY B	17.50	22.00	8.75			
172298-4214	WITHOUT	14	KEY B	21.00	25.50	10.50			
172298-4216	WITHOUT	16	KEY B	24.50	29.00	12.25			

30 MICROINCH GOLD PLATING								COLOR	PACKAGING SPEC.
PART NO.	KAPTON OPTION	CIRCUIT SIZE	KEY OPTION	DIM A	DIM F	DIM C			
172298-1304	WITHOUT	4	KEY A	3.50	8.00	1.75	BLACK	TRAY PK-172298-9001	
172298-1306	WITHOUT	6	KEY A	7.00	11.50	3.50			
172298-1308	WITHOUT	8	KEY A	10.50	15.00	5.25			
172298-1310	WITHOUT	10	KEY A	14.00	18.50	7.00			
172298-1312	WITHOUT	12	KEY A	17.50	22.00	8.75			
172298-1314	WITHOUT	14	KEY A	21.00	25.50	10.50			
172298-1316	WITHOUT	16	KEY A	24.50	29.00	12.25			
172298-2304	WITHOUT	4	KEY B	3.50	8.00	1.75			
172298-2306	WITHOUT	6	KEY B	7.00	11.50	3.50			
172298-2308	WITHOUT	8	KEY B	10.50	15.00	5.25			
172298-2310	WITHOUT	10	KEY B	14.00	18.50	7.00			
172298-2312	WITHOUT	12	KEY B	17.50	22.00	8.75			
172298-2314	WITHOUT	14	KEY B	21.00	25.50	10.50			
172298-2316	WITHOUT	16	KEY B	24.50	29.00	12.25			
172298-7304	WITH	4	KEY A	3.50	8.00	1.75			
172298-7306	WITH	6	KEY A	7.00	11.50	3.50			
172298-7308	WITH	8	KEY A	10.50	15.00	5.25			
172298-7310	WITH	10	KEY A	14.00	18.50	7.00			
172298-7312	WITH	12	KEY A	17.50	22.00	8.75			
172298-7314	WITH	14	KEY A	21.00	25.50	10.50			
172298-7316	WITH	16	KEY A	24.50	29.00	12.25			
172298-8304	WITHOUT	4	KEY A	3.50	8.00	1.75			
172298-8306	WITHOUT	6	KEY A	7.00	11.50	3.50			
172298-8308	WITHOUT	8	KEY A	10.50	15.00	5.25			
172298-8310	WITHOUT	10	KEY A	14.00	18.50	7.00			
172298-8312	WITHOUT	12	KEY A	17.50	22.00	8.75			
172298-8314	WITHOUT	14	KEY A	21.00	25.50	10.50			
172298-8316	WITHOUT	16	KEY A	24.50	29.00	12.25			
172298-3304	WITH	4	KEY B	3.50	8.00	1.75			
172298-3306	WITH	6	KEY B	7.00	11.50	3.50			
172298-3308	WITH	8	KEY B	10.50	15.00	5.25			
172298-3310	WITH	10	KEY B	14.00	18.50	7.00			
172298-3312	WITH	12	KEY B	17.50	22.00	8.75			
172298-3314	WITH	14	KEY B	21.00	25.50	10.50			
172298-3316	WITH	16	KEY B	24.50	29.00	12.25			
172298-4304	WITHOUT	4	KEY B	3.50	8.00	1.75			
172298-4306	WITHOUT	6	KEY B	7.00	11.50	3.50			
172298-4308	WITHOUT	8	KEY B	10.50	15.00	5.25			
172298-4310	WITHOUT	10	KEY B	14.00	18.50	7.00			
172298-4312	WITHOUT	12	KEY B	17.50	22.00	8.75			
172298-4314	WITHOUT	14	KEY B	21.00	25.50	10.50			
172298-4316	WITHOUT	16	KEY B	24.50	29.00	12.25			

TAPE REEL  
1722981000-PK

TAPE REEL  
1722981000-PK

TAPE REEL  
1722981000-PK

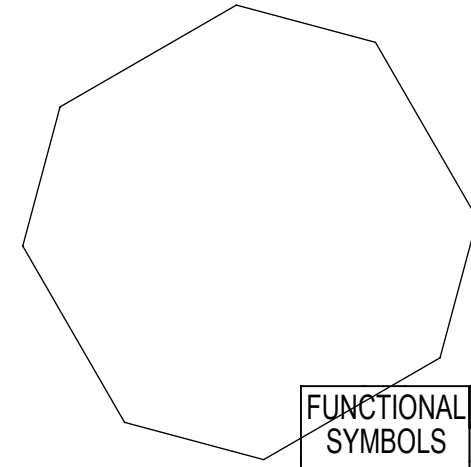

FUNCTIONAL SYMBOLS FA = 0 FC = 0 FD = 0	THIS DRAWING CONTAINS INFORMATION THAT IS PROPRIETARY TO MOLEX ELECTRONIC TECHNOLOGIES, LLC AND SHOULD NOT BE USED WITHOUT WRITTEN PERMISSION		CURRENT REV DESC:		
	DIMENSION UNITS mm	SCALE 1:1			
DIVISIONAL SYMBOLS	GENERAL TOLERANCES (UNLESS SPECIFIED)		EC NO: 653772		
	ANGULAR TOL ± °				
	4 PLACES ±	DRWN: GLLI 2021/01/05			
	3 PLACES ±	CHK'D: YXZHENG 2021/02/14			
	2 PLACES ± 0.25	APPR: YXZHENG 2021/02/14			
	1 PLACE ± 0.5	INITIAL REVISION: DRWN: DROSCA 2015/04/14			
	0 PLACES ±	APPR: RHODGE 2016/04/05		DOCUMENT NUMBER	
DRAFT WHERE APPLICABLE MUST REMAIN WITHIN DIMENSIONS		THIRD ANGLE PROJECTION	DRAWING	SERIES	DOC TYPE
			D-SIZE	172298	PSD
		GENERAL MARKET		000	REVISION
				C2	SHEET NUMBER
				3 OF 3	