

Sensor : IRA-S210ST01
Lens : IML-0685/0688

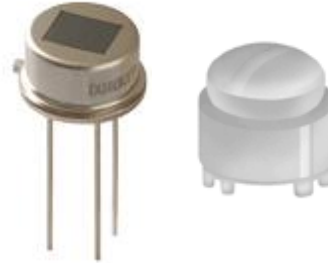

Pyro Electric Infrared Sensor Fresnel Lens

Features

- Excellent S/N
- Low voltage operation available

Applications

- Intrusion Detectors
- Lighting Automation

Please select IML-0685 or IML-0688 depend on your application and target detection area

Overview

Sensor

Pyroelectric infrared sensors detect infrared rays using the pyroelectric effect of pyroelectric ceramics, a kind of piezoelectric ceramics. IRA series offers pyroelectric infrared sensor that deliver high sensitivity and reliable performance made possible by Murata's ceramic technology and Hybrid IC technique expertise. Used mainly in security equipment. IRA-E series includes high quality and reliable performance products by improving the manufacturing process. Combining performance with low costs, the IRA-S series makes it easier to use pyroelectric infrared sensor in security application and general consumer equipment.

Lens

Lens series offer fresnel lens for Murata pyroelectric infrared sensor.

Attention:

This datasheet is downloaded from the website of Murata Manufacturing Co., Ltd. Therefore, it's specifications are subject to change or our products in it may be discontinued without advance notice. Please check with our sales representatives or product engineers before ordering.

TABLE OF CONTENT

1. Introduction	1
2. Specifications and Measurement Direction	3
2.1 Sensor		
2.2 Lens		
2.3 Selection Guide		
3. Dimension	8
3.1 Sensor		
3.2 Lens		
4. Packing	9
4.1 Sensor		
4.2 Lens		
5. ⚠CAUTION	9
5.1 Limitation of Applications		
5.2 Fall-Safe		
5.3 Notice in design		
5.4 Notice in handling and Storage		
5.5 Notice in mounting		
5.6 Other		

Attention:

This datasheet is downloaded from the website of Murata Manufacturing Co., Ltd.
Therefore, it's specifications are subject to change or our products in it may be discontinued without advance notice.
Please check with our sales representatives or product engineers before ordering.

2. Specifications and Measurement Direction

2.1 Sensor

2.1.1 Dimension of infrared ray receiving electrode (For reference)

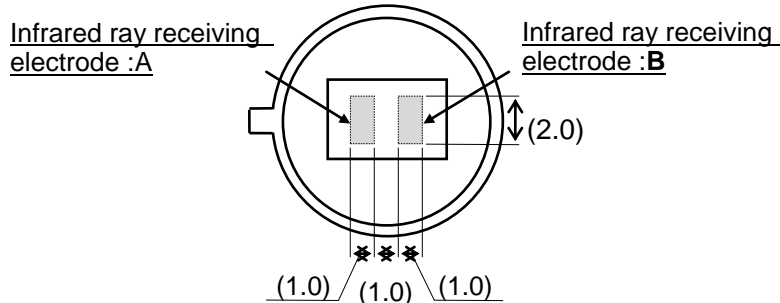

Fig.1 Top view

2.1.2 Internal circuit diagram

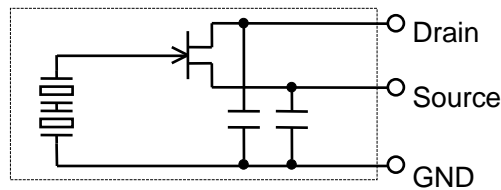

Fig.2 Circuit diagram

2.1.3 Basic (rated) operation conditions

Table.1 Operation conditions

Parameter	Spec	Notes
Supply Voltage	2.0 to 15.0 VDC (With circuit condition shown in Fig.7)	Supply Voltage means the difference of electrical potential between Drain terminal and Ground terminal,
Operating Temperature range	-40 to 70 °C	
Storage Temperature range	-40 to 85 °C	

2.1.4 Performances (Unless otherwise noted 25°C±3°C)

Table.2 Performance of electric specifications

Parameter	Unit	Symbol	Min.	Typ.	Max.	Test condition	
Responsivity	mV	R_A R_B	3.6	(4.6)	-	Refer to (Note 1)	
Balance of Responsivity	%	-	-	-	10	-	
White Noise	mVpp	W_n	-	-	150	Refer to (Note 2)	
Source Voltage	at 25°C	V	V_s	0.2	-	1.5	Refer to (Note 3)

Attention:

This datasheet is downloaded from the website of Murata Manufacturing Co., Ltd. Therefore, its specifications are subject to change or our products in it may be discontinued without advance notice. Please check with our sales representatives or product engineers before ordering.

2.1 5 Measurement Direction

Note1 : Test system of Responsivity

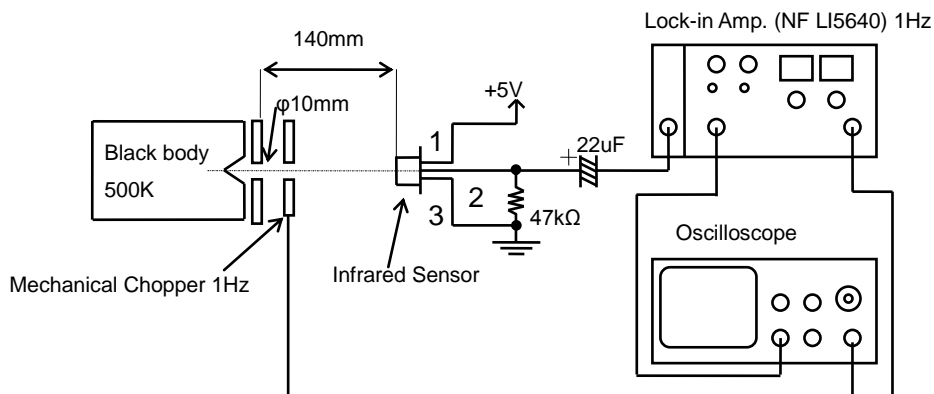

Fig.3 Test system

Note1 : Test circuit for White Noise

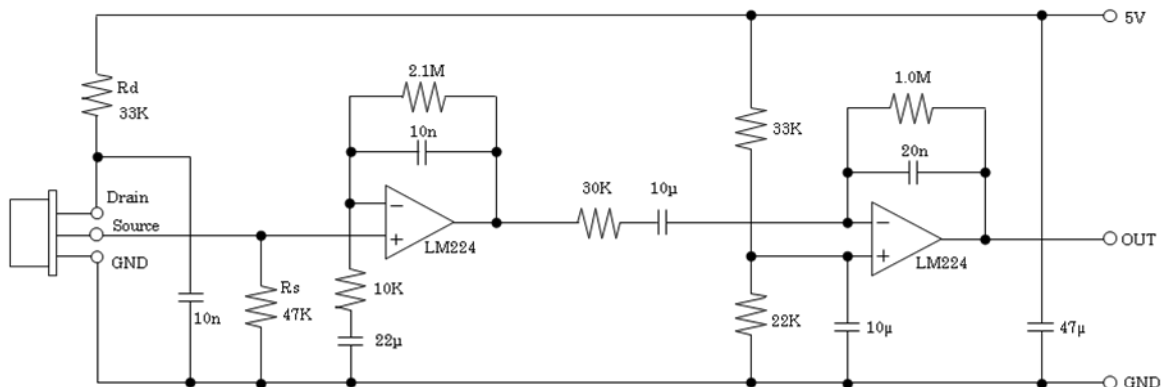

Fig.4 Test circuit for White noise

Note3 : Test circuit for Source Voltage

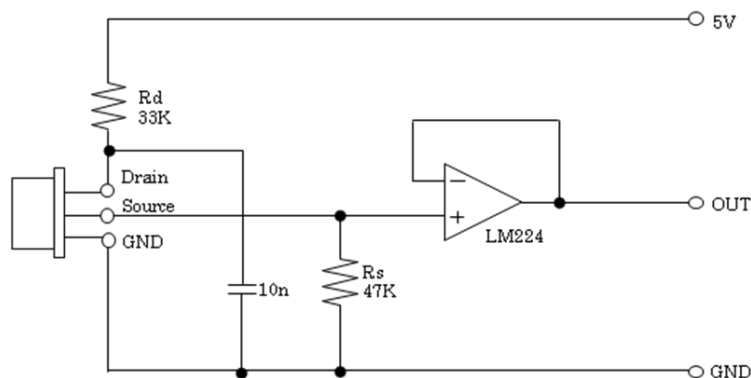

Fig.5 Test circuit for source voltage

Attention:

This datasheet is downloaded from the website of Murata Manufacturing Co., Ltd. Therefore, its specifications are subject to change or our products in it may be discontinued without advance notice. Please check with our sales representatives or product engineers before ordering.

2.2 Lens

2.2.1 Basic Characteristic

Table.3 Basic Characteristic

Parameter	Spec
Material	High density polyethylene
Operating Temperature range	-25 to 60 °C
Storage Temperature range	-30 to 80 °C

2.2.2 Transmittance

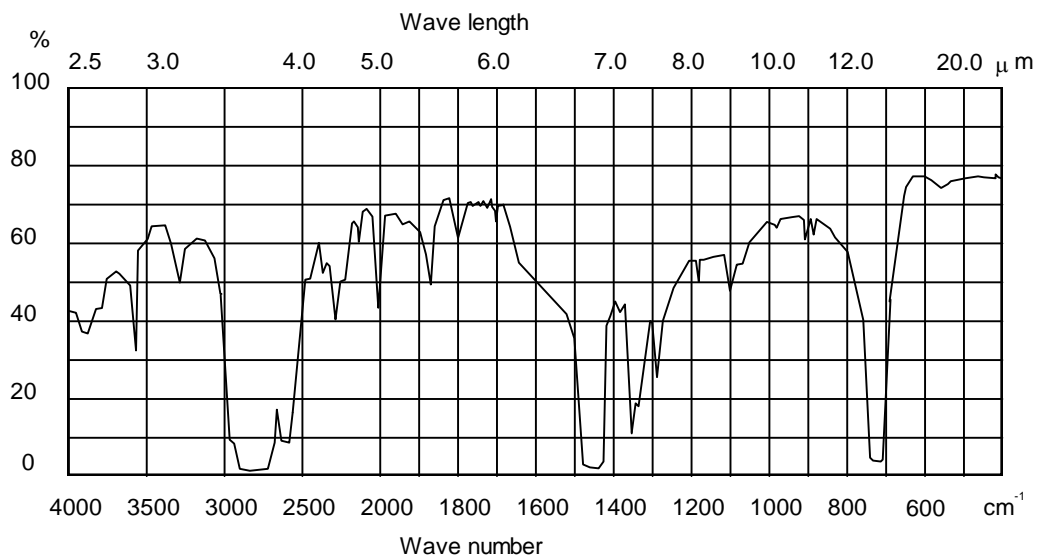

Fig.6 Transmittance

2.3 Selection Guide of Lens

Please select IML-0685 or IML-0688 depend on your application and target detection area.

2.3.1 IML-0685

For Wall mount type (Inline type)

This lens is good at detecting the motion across target area.

2.3.2 IML-0688

For Ceiling type and Wall mount type (Round type).

This lens has more optical segments compared with IML-0685.

Attention:

This datasheet is downloaded from the website of Murata Manufacturing Co., Ltd. Therefore, it's specifications are subject to change or our products in it may be discontinued without advance notice. Please check with our sales representatives or product engineers before ordering.

2.3.3 Detection area

IML-0685

*Assembled with Murata sensor IRA-S210ST01.

Combined lens tab A to sensor tab

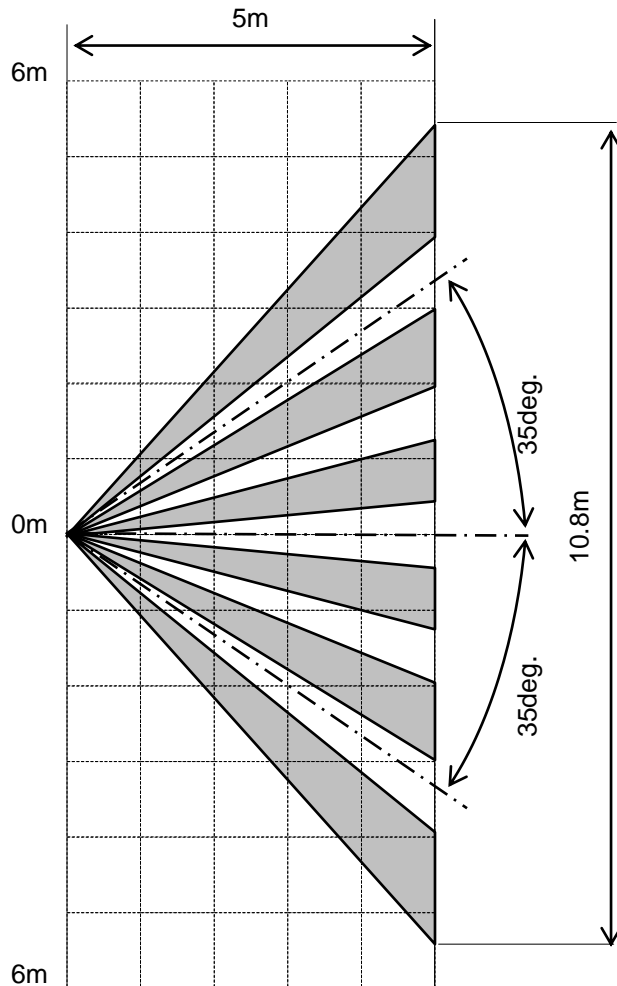

Fig.7 Horizontal detection area

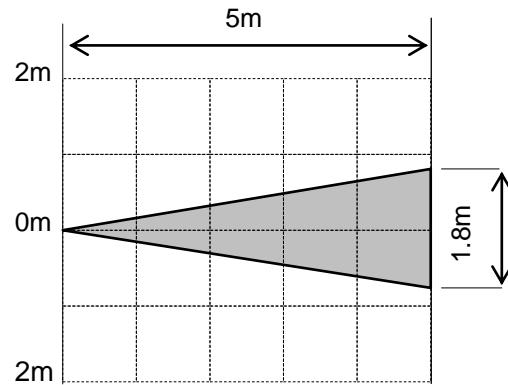

Fig.8 Vertical detection area

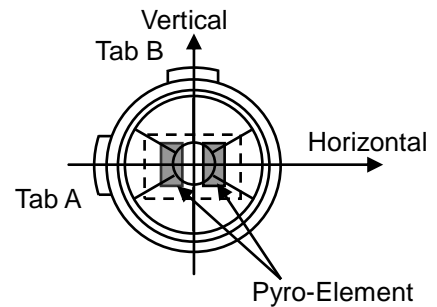

Fig.9 Assembled with sensor

Attention:

This datasheet is downloaded from the website of Murata Manufacturing Co., Ltd. Therefore, it's specifications are subject to change or our products in it may be discontinued without advance notice. Please check with our sales representatives or product engineers before ordering.

IML-0688

*Assembled with Murata sensor IRA-S210ST01.

Combined lens tab A to sensor tab

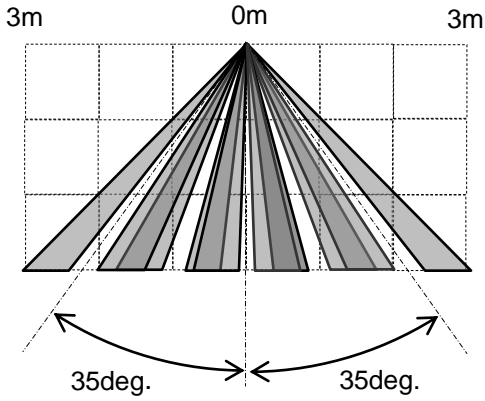

Fig.10 Horizontal detection area

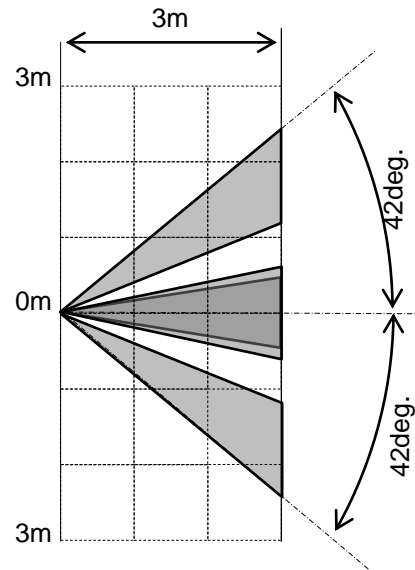

Fig.11 Vertical detection area

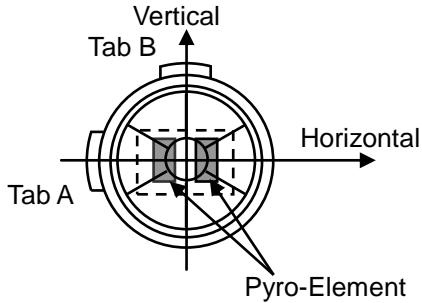

Fig.12 Assembled with sensor

Attention:

This datasheet is downloaded from the website of Murata Manufacturing Co., Ltd. Therefore, its specifications are subject to change or our products in it may be discontinued without advance notice. Please check with our sales representatives or product engineers before ordering.

3. Dimension

3.1 Sensor : IRA-S210ST01

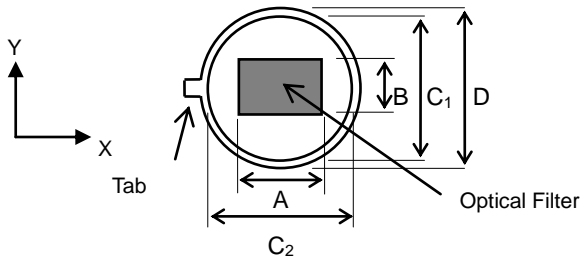

Fig.13 Top view

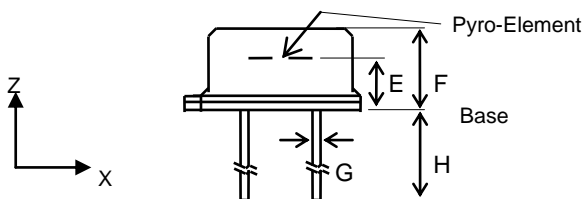

Fig.14 Side view

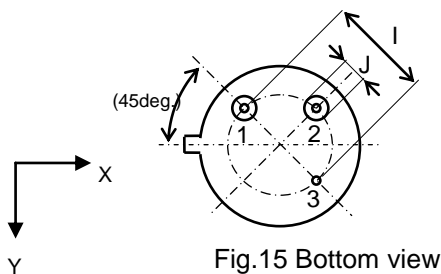

Fig.15 Bottom view

Symbol	Dimension [mm]
A	4.7±0.1
B	3.7±0.1
C ₁	8.0±0.1
C ₂	8.2±0.1
D	9.2±0.2
E	3.5±0.2
F	4.7±0.2
G	0.45±0.05
H	13.5±2
I	5.08±0.15
J	1.5±0.1

Symbol	Description
1 (Drain)	Supply Voltage
2 (Source)	Output
3 (Ground)	Ground

Notes)

- Nickel-plated on terminal. However the terminal cut
- C₁ and C₂ are specified on 1.2mm from base
- I is specified on base

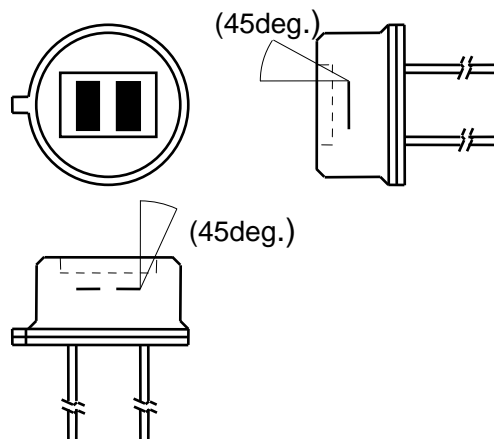

Fig.16 Field of view

Attention:

This datasheet is downloaded from the website of Murata Manufacturing Co., Ltd. Therefore, it's specifications are subject to change or our products in it may be discontinued without advance notice. Please check with our sales representatives or product engineers before ordering.

4. Packing

4.1 Sensor

100 pieces sensors shall be packed in a unit box (box size: LWD (mm) 104x75x47) as shown in Fig.19

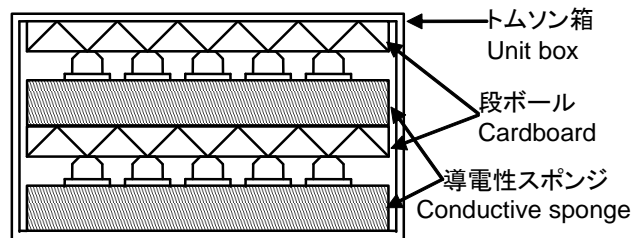

Fig. 19 Packing configuration of Sensor

4.2 Lens

100 pieces lenses shall be packed in a plastic bag as shown in Fig.20.

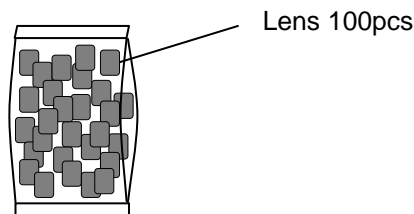

Fig.20 Packing configuration of Lens

5. ⚠Caution

5.1 Limitation of Applications

Please do not use in the applications listed below which require a high reliability to prevent the defects which might cause a damage to the Peoples' life and/or property.

- 1) Aircraft equipment
- 2) Aerospace equipment
- 3) Undersea equipment
- 4) Power plant control equipment
- 5) Medical equipment
- 6) Transportation equipment (trains, ships, etc.)
- 7) Traffic signal equipment
- 8) Disaster prevention / crime prevention equipment
- 9) Data-processing equipment
- 10) Military equipment (regardless of directly/indirectly)
- 11) Security device/system
- 12) Outside-usage, in which the sensor is exposed to splashes or dusts

Application of similar complexity and/or reliability requirement to the applications listed in the above

Attention:

This datasheet is downloaded from the website of Murata Manufacturing Co., Ltd.
 Therefore, its specifications are subject to change or our products in it may be discontinued without advance notice.
 Please check with our sales representatives or product engineers before ordering.

5.2 Fail-Safe

Please make sure to provide an appropriate fail-safe function on your product to prevent a second damage that may be caused by the abnormal function or the failure of our product

5.3 Notice in Design

5.3.1 Sensor

- 1) In the case of outdoor use, suitable Optical Filter and water and humidity proof structure should be applied.
- 2) To prevent failure or malfunction, Please use a stabilized power supply.
- 3) Please avoid using the sensor in the following conditions because it may cause failure or malfunction ;
 - a) In such a fluid as water, alcohol etc. corrosive gas (SO₂, Cl₂, NO_x etc.) or sea breeze.
 - b) In high humidity.
 - c) In a place exposed directly to sunlight or headlight of automobile.
 - d) In a place exposed to rapid ambient temperature change.
 - e) In a place exposed directly to blow from air-conditioner or heater.
 - f) In a place exposed to strong vibration.
 - g) In a place exposed to strong electromagnetic field.
 - h) In such a place where infrared ray is shaded.
 - i) In such a place are charge field and static electricity field.
 - j) In any other place similar to the above (a) through (i).

5.3.2 Lens

Please avoid using the fresnel lens in the following conditions because it may cause failure or malfunction ;

- a) in such a fluid as water, alcohol etc. corrosive gas (SO₂, Cl₂, NO_x etc.) or sea breeze.
- b) in high humidity.
- c) in a place exposed directly to sun light or headlight of automobile.
- d) in a place exposed directly to blow from air-conditioner or heater.
- e) in such a place where infrared ray is shaded.
- f) in any other place similar to the above (a) through (e).

Attention:

This datasheet is downloaded from the website of Murata Manufacturing Co., Ltd.
Therefore, it's specifications are subject to change or our products in it may be discontinued without advance notice.
Please check with our sales representatives or product engineers before ordering.

5.4 Notice in handling and storage

5.4.1 Sensor

- 1) Optical Filter of sensor should not be scratched or soiled.
- 2) Strong shock should be avoided.
- 3) It may malfunction under electrostatics and electromagnetic field.
Please use it after enough evaluating.
- 4) Electrostatics and strong electromagnetic field should be avoided.
- 5) Sensor should be kept on conductive sponge
- 6) High temperature, high humidity, fluid as water or alcohol etc., corrosive gas (SO₂, Cl₂, NO_x etc.) and sea breeze should be avoided.
- 7) Store the products where the temperature and relative humidity do not exceed -10 to 40 degrees centigrade, and 15 to 85%RH. Use the products within 6 months after receiving. Check the terminal solderability before use if the product has been stored for more than 6 months.
- 8) The terminal cut section does not have plating.
So there is possibility to rust on cutting section depending on environment.

5.4.1 Lens

- 1) Optical filter of sensor should not be scratched or soiled.
- 2) Strong shock should be avoided.
- 3) High temperature, high humidity, fluid as water or alcohol etc., corrosive gas (SO₂, Cl₂, NO_x etc.) and sea breeze should be avoided.

5.5 Notice in mounting (Sensor)

- 1) Please perform the soldering of the terminal with an iron point solder.
- 2) Please mount the soldering of the terminal as quick as possible. Specifically, please go in the range of follows.

Table.4 Soldering condition

iron point temperature : 350 degree C	
Terminal length from stem	Time
1 to 3mm	Less than 3sec by a terminal
Over 3mm	Less than 10sec by a terminal

- 3) Please use the flux which has a water-soluble thing less than chlorine content 0.2% by weight.
- 4) Please completely remove the flux after the soldering. When you are insufficient, it causes the malfunction.

*Please follow soldering conditions described in the specification.
This product can permanently stop operating if the piezoelectric (pyro electric) characteristic is decreased due to excessive heating

Attention:

This datasheet is downloaded from the website of Murata Manufacturing Co., Ltd.
Therefore, it's specifications are subject to change or our products in it may be discontinued without advance notice.
Please check with our sales representatives or product engineers before ordering.

5.6 Other

- 1) Please make sure that your product has been evaluated in view of your specifications with our product being mounted to your product.
- 2) You are requested not to use our product deviating from this product specification.
- 3) We consider it not appropriate to include any terms and conditions with regard to the business transaction in the product specifications, drawings or other technical documents. Therefore, if your technical documents as above include such terms and conditions such as warranty clause, product liability clause, intellectual property infringement liability clause, or export control clause, they will be deemed to be invalid.

Attention:

This datasheet is downloaded from the website of Murata Manufacturing Co., Ltd. Therefore, it's specifications are subject to change or our products in it may be discontinued without advance notice. Please check with our sales representatives or product engineers before ordering.