

## SP1009 Series 30pF 30kV Bidirectional Discrete TVS

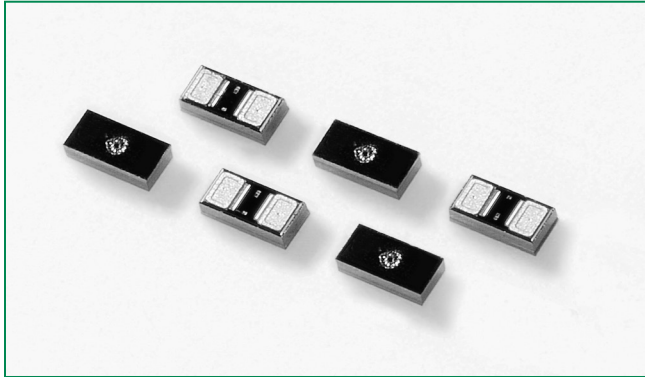

**OBSOLETE** DATE: 12/31/2020 PCN/ECN# ESU270-48  
REPLACED BY: SP1026-01UTG



### Pinout

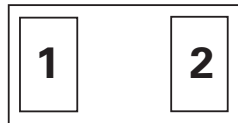

### Functional Block Diagram



### Description

The SP1009 includes back-to-back Zener diodes fabricated in a proprietary silicon avalanche technology to provide protection for electronic equipment that may experience destructive electrostatic discharges (ESD). These robust diodes can safely absorb repetitive ESD strikes above the maximum level specified in the IEC61000-4-2 international standard (Level 4,  $\pm 8$  kV contact discharge and  $\pm 15$  kV air discharge) without performance degradation. The back-to-back configuration provides symmetrical ESD protection for data lines when AC signals are present.

### Features

- ESD, IEC61000-4-2,  $\pm 30$ kV contact,  $\pm 30$ kV air
- EFT, IEC61000-4-4, 40A (5/50ns)
- IEC 61000-4-5, 2nd Edition: 8/20 Surge, 10A Surge Immunity
- Low capacitance of 30pF (@  $V_R = 0V$ )
- Low leakage current of  $0.1\mu A$  at 5V
- Space efficient 0201 footprint
- Halogen free, lead-free and RoHS compliant.

### Applications

- Mobile phones
- Smart phones
- Camcorders
- PDA
- Digital cameras
- MP3/PMP
- Portable navigation devices
- Portable medical
- Point of sale terminals

### Application Example

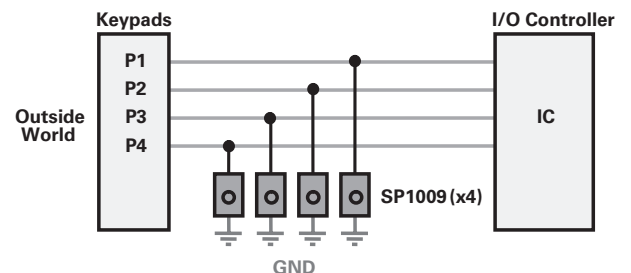

Life Support Note:

**Not Intended for Use in Life Support or Life Saving Applications**

The products shown herein are not designed for use in life sustaining or life saving applications unless otherwise expressly indicated.

### Absolute Maximum Ratings

Symbol	Parameter	Value	Units
$I_{PP}$	Peak Current ( $t_p=8/20\mu s$ )	10.0	A
$T_{OP}$	Operating Temperature	-40 to 85	°C
$T_{STOR}$	Storage Temperature	-65 to 150	°C

CAUTION: Stresses above those listed in "Absolute Maximum Ratings" may cause permanent damage to the component. This is a stress only rating and operation of the component at these or any other conditions above those indicated in the operational sections of this specification is not implied.

### Thermal Information

Parameter	Rating	Units
Storage Temperature Range	-65 to 150	°C
Maximum Junction Temperature	150	°C
Maximum Lead Temperature (Soldering 20-40s)	260	°C

### Electrical Characteristics ( $T_{OP}=25^\circ C$ )

Parameter	Symbol	Test Conditions	Min	Typ	Max	Units
Reverse Standoff Voltage	$V_{RWM}$				6.0	V
Breakdown Voltage	$V_{BR}$	$I_R=1mA$	7.0	8.5	9.5	V
Leakage Current	$I_{LEAK}$	$V_R=5V$ with 1 pin at GND		0.1	0.5	$\mu A$
Clamp Voltage <sup>1</sup>	$V_C$	$I_{PP}=1A, t_p=8/20\mu s, Fwd$		9.3		V
		$I_{PP}=2A, t_p=8/20\mu s, Fwd$		10.0		V
		$I_{PP}=10A, t_p=8/20\mu s, Fwd$		15.6		V
Dynamic Resistance	$R_{DYN}$	$(V_{C2} - V_{C1}) / (I_{PP2} - I_{PP1})$		0.7		$\Omega$
ESD Withstand Voltage <sup>1</sup>	$V_{ESD}$	IEC61000-4-2 (Contact Discharge)	$\pm 30$			kV
		IEC61000-4-2 (Air Discharge)	$\pm 30$			kV
Diode Capacitance <sup>1</sup>	$C_D$	Reverse Bias=0V		30		pF
		Reverse Bias=2.5V		23		pF

Note:

<sup>1</sup>Parameter is guaranteed by design and/or component characterization.

### Product Characteristics

<b>Lead Plating</b>	Sn
<b>Lead Material</b>	Copper
<b>Lead Coplanarity</b>	6 $\mu m$ (max)
<b>Substrate material</b>	Silicon
<b>Body Material</b>	Silicon

Notes :

- All dimensions are in millimeters
- Dimensions include solder plating.
- Dimensions are exclusive of mold flash & metal burr.
- Blo is facing up for mold and facing down for trim/form, i.e. reverse trim/form.
- Package surface matte finish VDI 11-13.

**Capacitance vs. Reverse Bias**

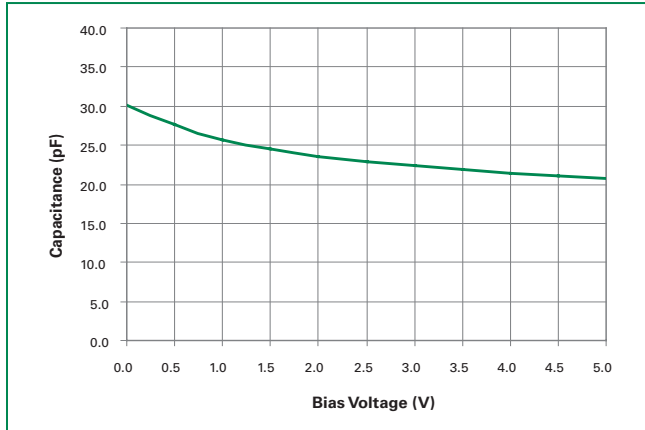

**8/20µS Pulse Waveform**

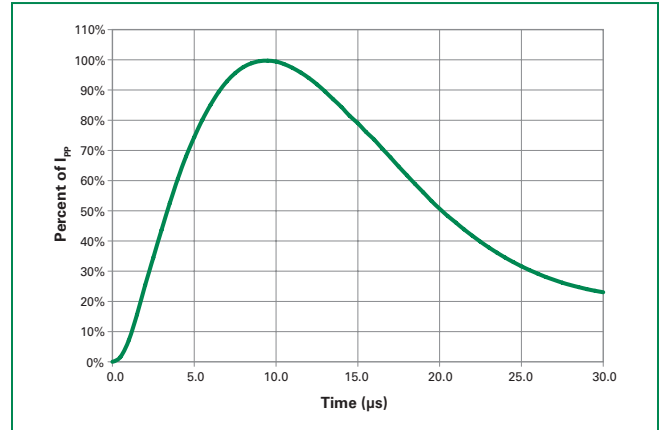

**Clamping Voltage vs. I<sub>pp</sub>**

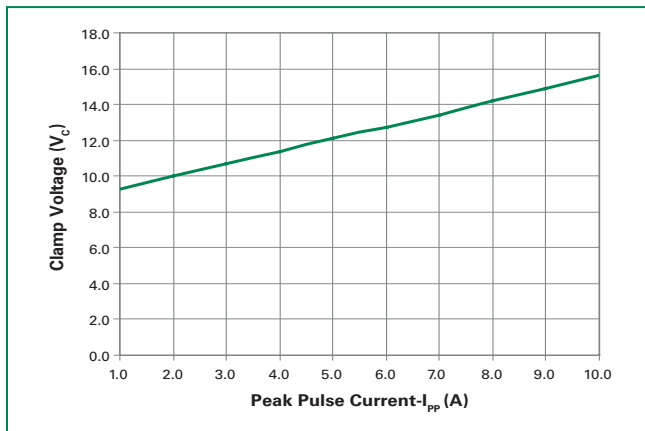

**Insertion Loss (S21) I/O to GND**

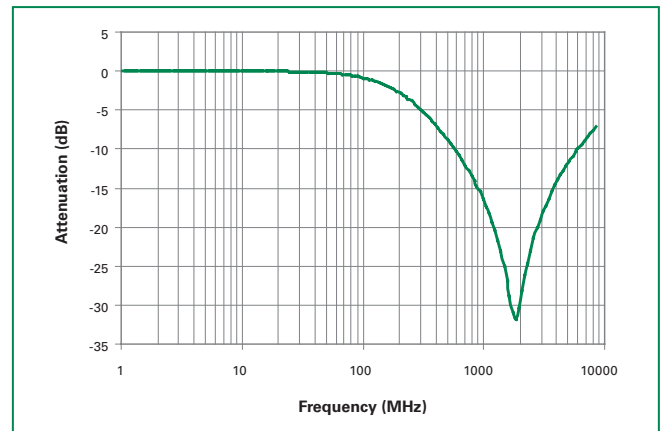

**Soldering Parameters**

Reflow Condition	Pb – Free assembly	
Pre Heat	- Temperature Min (T <sub>s(min)</sub> )	150°C
	- Temperature Max (T <sub>s(max)</sub> )	200°C
	- Time (min to max) (t <sub>s</sub> )	60 – 180 secs
Average ramp up rate (Liquidus) Temp (T <sub>L</sub> ) to peak	3°C/second max	
T <sub>S(max)</sub> to T <sub>L</sub> - Ramp-up Rate	3°C/second max	
Reflow	- Temperature (T <sub>L</sub> ) (Liquidus)	217°C
	- Temperature (t <sub>L</sub> )	60 – 150 seconds
Peak Temperature (T <sub>p</sub> )	260 <sup>+0/-5</sup> °C	
Time within 5°C of actual peak Temperature (t <sub>p</sub> )	20 – 40 seconds	
Ramp-down Rate	6°C/second max	
Time 25°C to peak Temperature (T <sub>p</sub> )	8 minutes Max.	
Do not exceed	260°C	

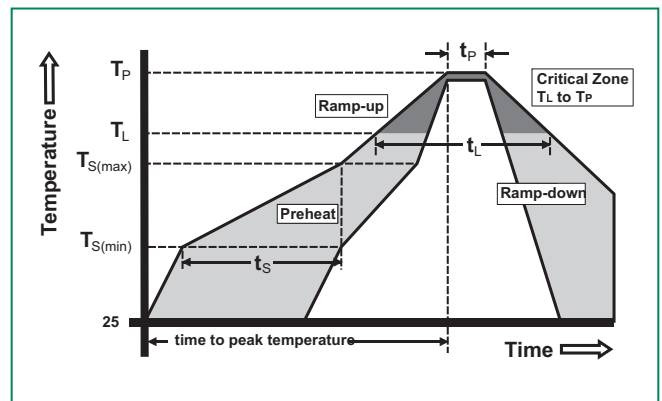

**Package Dimensions – 0201 Flipchip**

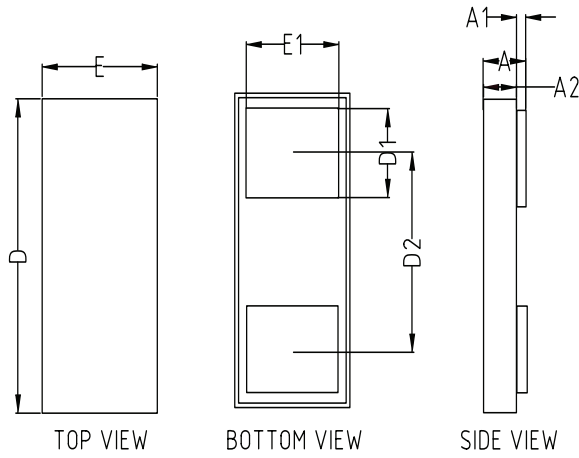

Symbol	0201 Flipchip			
	Millimeters		Inches	
	Min	Max	Min	Max
<b>D</b>	0.605	0.655	0.023819	0.025787
<b>E</b>	0.305	0.355	0.012008	0.013976
<b>D1</b>	0.145	0.155	0.005709	0.006102
<b>E1</b>	0.245	0.255	0.009646	0.010039
<b>D2</b>	0.4 BSC		0.0157 BSC	
<b>A</b>	0.273	0.329	0.010748	0.012953
<b>A2</b>	0.265	0.315	0.010433	0.012402
<b>A1</b>	0.008	0.014	0.000315	0.000551

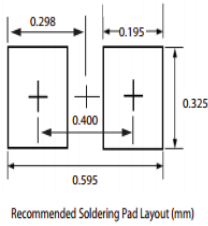

**Part Numbering System**

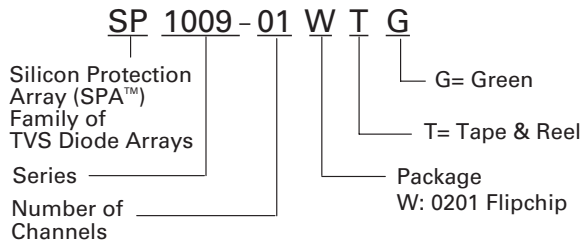

**Part Marking System**

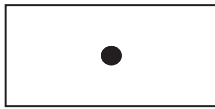

**Ordering Information**

Part Number	Package	Marking	Min. Order Qty.
SP1009-01WTG	0201 Flipchip	•	10000

**Embossed Carrier Tape & Reel Specification – 0201 Flipchip**

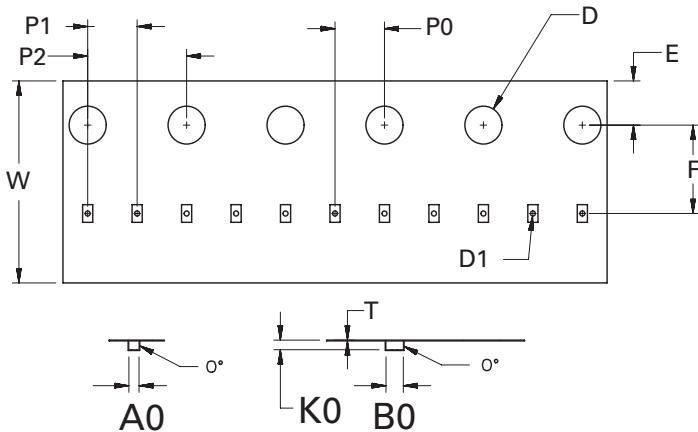

Symbol	Millimeters
<b>A0</b>	0.41+/-0.03
<b>B0</b>	0.70+/-0.03
<b>D</b>	ø 1.50 + 0.10
<b>D1</b>	ø 0.20 +/- 0.05
<b>E</b>	1.75+/-0.10
<b>F</b>	3.50+/-0.05
<b>K0</b>	0.38+/-0.03
<b>P0</b>	2.00+/-0.05
<b>P1</b>	2.00+/-0.05
<b>P2</b>	4.00+/-0.10
<b>W</b>	8.00+0.30/-0.10
<b>T</b>	0.23+/-0.02