

PROTECTION PRODUCTS

Description

RClamp®0532T is a high performance TVS array designed to protect two differential lines from overvoltage events caused by ESD, lightning, CDE (Cable Discharge Events) and EFT (electrical fast transients). RClamp0532T features high surge current capability and may be used to protect Ethernet interfaces in MagJacks, communications equipment, security cameras, and industrial equipment.

RClamp0532T integrates low capacitance, surge-rated steering diodes with a high power transient voltage suppressor (TVS). The TVS utilizes snap-back or “crow-bar” technology to minimize device clamping voltage and features high surge current capability of 10A ($t_p=8/20\mu s$). ESD characteristics are highlighted by high ESD withstand voltage ($\pm 30kV$ per IEC 61000-4-2) and extremely low dynamic resistance (0.020 Ohms typical). Each device will protect two lines operating at 5 volts.

RClamp0532T is in a 6-pin SLP1610P4T package measuring 1.6 x 1.0mm with a nominal height of 0.40mm. Flow-through package design simplifies PCB layout and maintains signal integrity on high-speed lines. The combination of low clamping, high surge capability, and innovative package design enables this device to provide the highest level of transient protection.

Nominal Dimensions

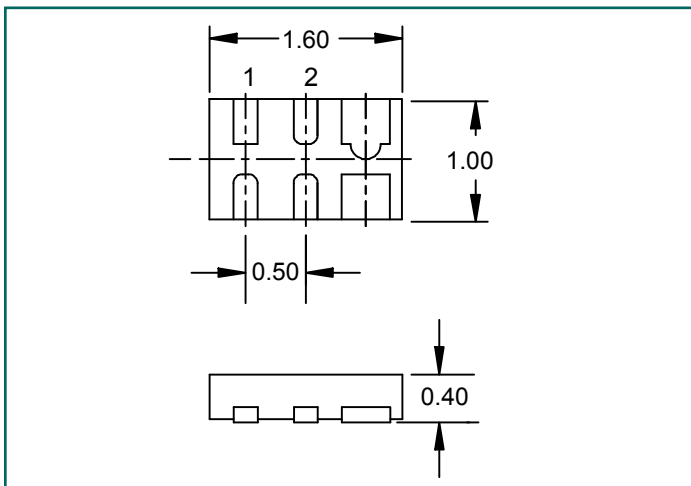

Features

- Transient Protection to
 - ♦ IEC 61000-4-2 (ESD) 30kV (Air), 30kV (Contact)
 - ♦ IEC 61000-4-4 (EFT) 4kV (5/50ns)
 - ♦ IEC 61000-4-5 (Lightning) 10A (8/20 μs)
- Very Small PCB Area
- Protects two High-Speed Data Lines
- Working Voltage: 5V
- Low Capacitance: 0.60pF Typical
- Dynamic Resistance: 0.020 Ohms (Typ)
- Solid-State Silicon-Avalanche Technology

Mechanical Characteristics

- SLP1610P4T Package
- Pb-Free, Halogen Free, RoHS/WEEE Compliant
- Nominal Dimensions: 1.6 x 1.0 x 0.40 mm
- Lead Finish: NiPdAu
- Molding Compound Flammability Rating: UL 94V-0
- Marking : Marking Code + Date Code
- Packaging : Tape and Reel

Applications

- 1G/2.5G/5G/10G Ethernet
- Integrated Magnetics / RJ-45 Connectors
- Central Office Equipment
- Industrial Equipment
- IP Camera

Functional Schematic

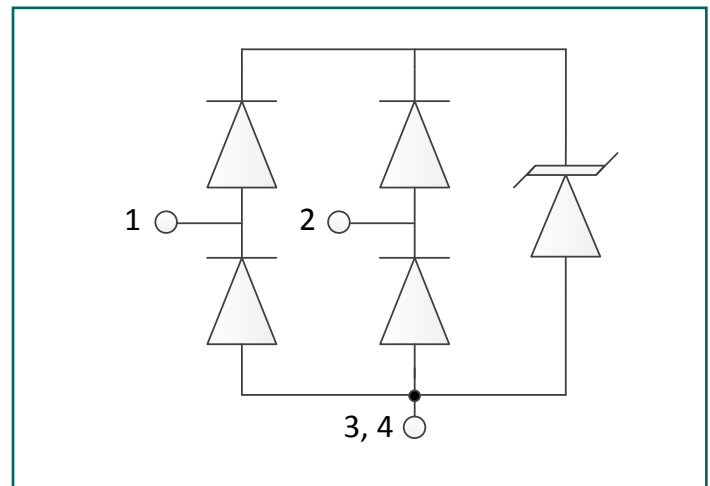

Absolute Maximum Ratings

Rating	Symbol	Value	Units
Peak Pulse Power (tp = 8/20μs)	P _{PK}	100	W
Peak Pulse Current (tp = 8/20μs)	I _{PP}	10	A
ESD per IEC 61000-4-2 (Contact) ⁽¹⁾ ESD per IEC 61000-4-2 (Air) ⁽¹⁾	V _{ESD}	±30 ±30	kV
Operating Temperature	T _J	-40 to +125	°C
Storage Temperature	T _{STG}	-55 to +150	°C

Electrical Characteristics (T=25°C unless otherwise specified)

Parameter	Symbol	Conditions	Min.	Typ.	Max.	Units	
Reverse Stand-Off Voltage	V _{RWM}	-40°C to 125°C Pin 1 or Pin 2 to Pins 3 and 4			5	V	
Reverse Breakdown Voltage	V _{BR}	I _t = 10mA, Pin 1 or Pin 2 to Pins 3 and 4	-40°C to 125°C	6.5	9.5	11.5	V
Holding Current	I _H	Pin 1 or Pin 2 to Pins 3 and 4	T = 25°C	75	150	250	mA
Reverse Leakage Current	I _R	V _{RWM} = 5V	T = 25°C		0.01	0.100	μA
			T = 125°C		0.03	0.250	μA
Clamping Voltage ⁽²⁾	V _C	I _{pp} = 10A, tp = 1.2/50μs, Pin 1 or Pin 2 to Pins 3 and 4		6.5	10	V	
ESD Clamping Voltage ⁽³⁾	V _C	I _{pp} = 4A, tp = 0.2/100ns (TLP) Pin 1 or Pin 2 to Pins 3 and 4		3.5		V	
ESD Clamping Voltage ⁽³⁾	V _C	I _{pp} = 16A, tp = 0.2/100ns (TLP) Pin 1 or Pin 2 to Pins 3 and 4		3.75		V	
Dynamic Resistance ^{(3),(4)}	R _{DYN}	tp = 0.2/100ns (TLP) Pin 1 or Pin 2 to Pins 3 and 4		0.020		Ohms	
Junction Capacitance	C _J	V _R = 0V, f = 1MHz Pin 1 or Pin 2 to Pins 3 and 4	T = 25°C		1	1.2	pF
		V _R = 0V, f = 1MHz Pin 1 to Pin 2	T = 25°C		0.6	0.7	pF

Notes:

(1): ESD Gun return path to Ground Reference Plane (GRP)

(2): Measured using a 1.2/50us voltage, 8/20us current combination waveform, RS = 8 Ohms. Clamping is defined as the peak voltage across the device after the device snaps back to a conducting state.

(3): Transmission Line Pulse Test (TLP) Settings: tp = 100ns, tr = 0.2ns, I_{TLP} and V_{TLP} averaging window: t₁ = 70ns to t₂ = 90ns.

(4): Dynamic resistance calculated from I_{TLP} = 4A to I_{TLP} = 16A

Typical Characteristics

Non-Repetitive Peak Pulse Power vs. Pulse Time

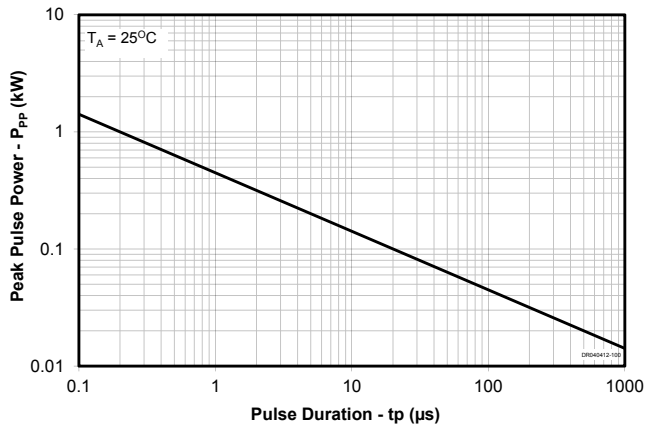

Power Derating Curve

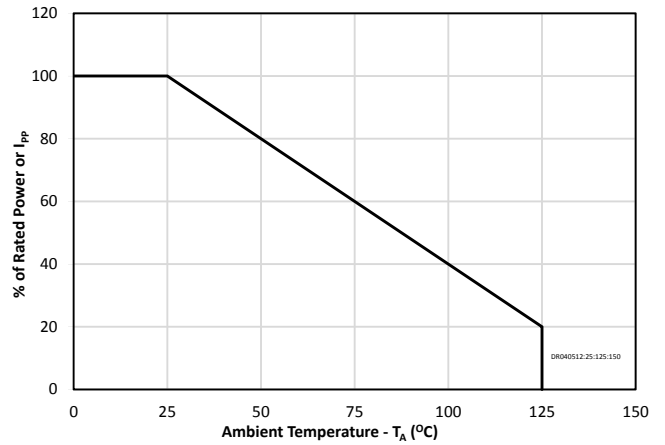

Clamping Characteristic (10A, 1.2/50us Pulse)

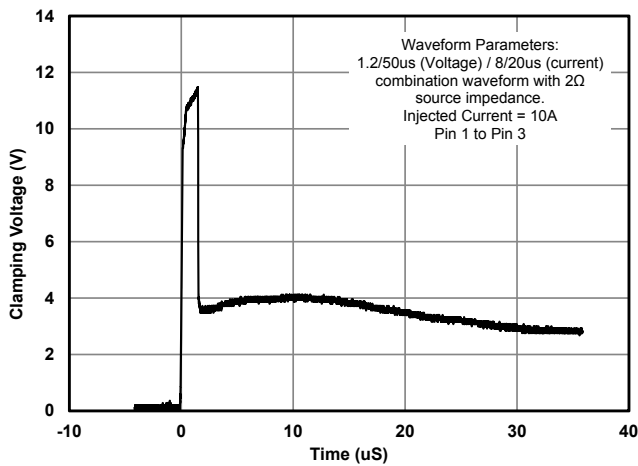

TLP IV Curve (Positive Pulse)

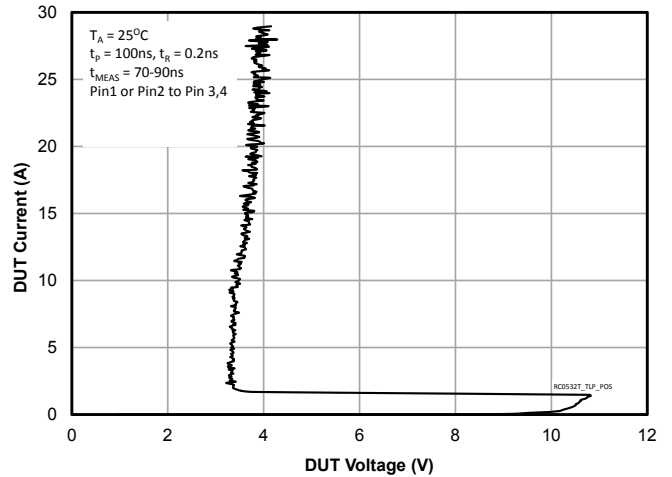

ESD Clamping (+8kV Contact per IEC 61000-4-2)

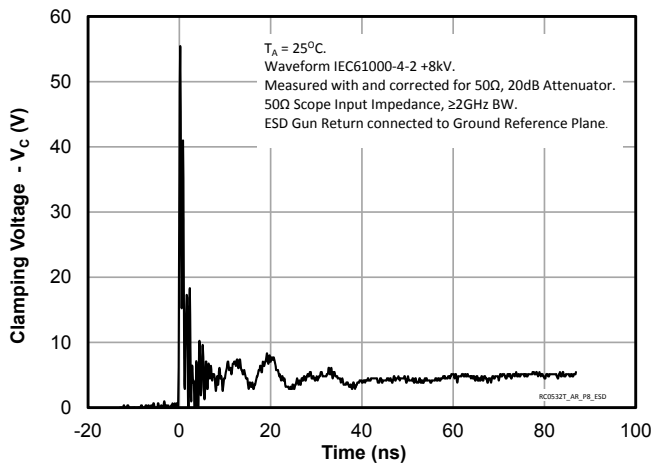

ESD Clamping (-8kV Contact per IEC 61000-4-2)

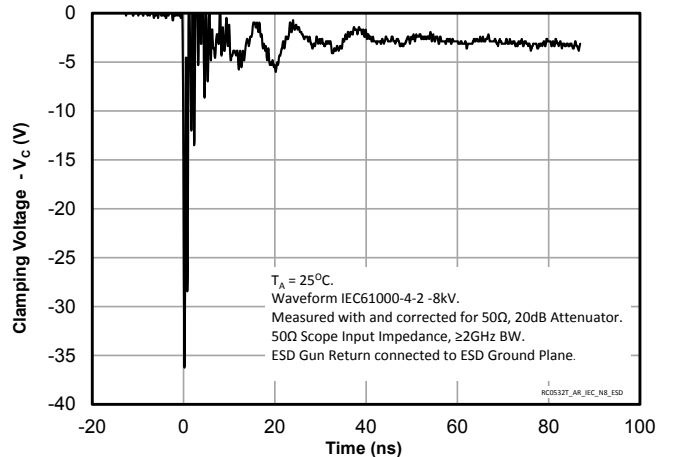

Typical Characteristics (Continued)

Capacitance vs. Reverse Voltage

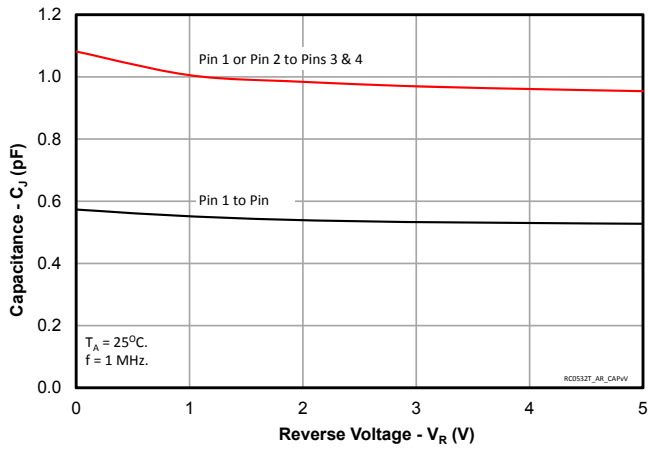

Capacitance vs. Temperature

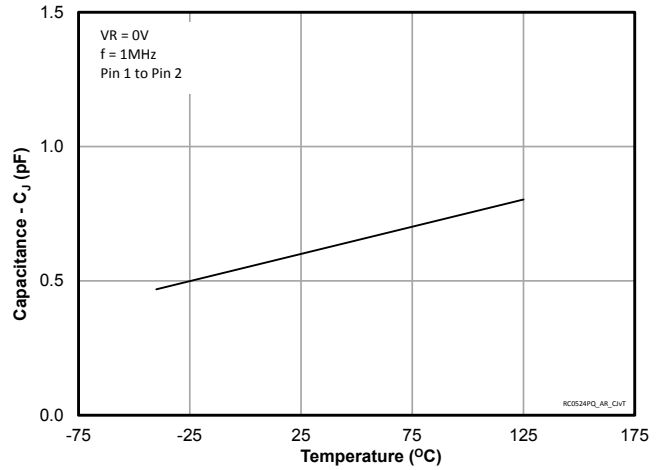

Insertion Loss - S21

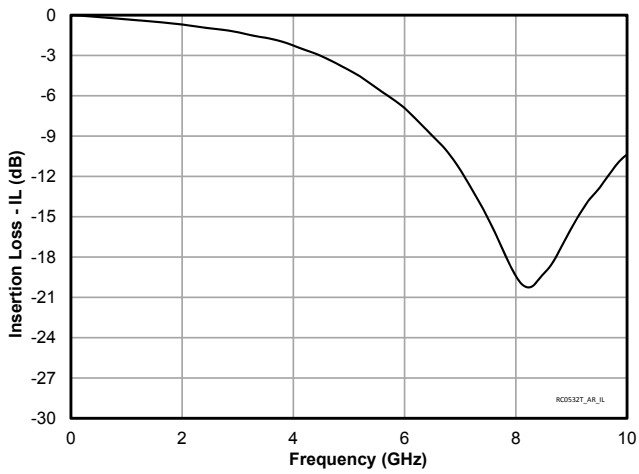

Application Information

Ethernet Protection

Ethernet ports are exposed to external transient events in the form of ESD, EFT, lightning, and cable discharge events (CDE). Test standards that model these events include IEC 61000-4-2 for ESD, IEC 61000-4-4 for EFT, and IEC 61000-4-5 and GR-1089 for lightning. Any of these events can cause catastrophic damage to the PHY IC.

When designing Ethernet protection, the entire system must be considered. Over-voltage events can be common mode (with respect to ground) or differential (line-to-line). An Ethernet port includes interface magnetics consisting of transformers integrated with common mode chokes. The transformer center taps are connected to ground via an RC network or “Bob Smith” termination. The purpose of this termination is to reduce common mode emissions. The transformer provides common mode isolation to transient events, but no protection for differential surges. During a differential transient event, current will flow through the transformer, charging the windings on the line side. Energy is transferred to the secondary until the surge subsides or the transformer saturates.

A typical protection scheme which utilizes RClamp0532T is shown in Figure 1. Four each RClamp0532T are located on the PHY side of the transformer. Each device will protect one line pair (two lines). Parasitic inductance in

the protection path should be minimized by locating RClamp0532T as physically close to the magnetics as possible, and preferably on the same side of the PCB. Reducing parasitic inductance is especially important for suppressing fast rise time transients such as ESD and EFT. Inductance in the path of the protection device increases the peak clamping voltage seen by the protected device ($V = L di/dt$). For example, 1nH of inductance can increase the peak clamping voltage by 30V for a 30A (8kV) ESD pulse with a 1ns rise time. Differential pairs are routed through pins 1 to 6, and 2 to 5. Pin 3 and 4 are not connected.

Placing the protection on the PHY side of the magnetics is advantageous in that the magnitude and duration of the surge is attenuated by the transformer windings. The amount of attenuation will vary by vendor and configuration of the magnetics. The Ethernet transformer must be able to support the impulse tests without failure. A typical Ethernet transformer can withstand a few hundred amperes ($t_p=8/20\mu s$) before failure occurs, but this needs to be verified by testing. Alternatively, the protection can be placed on the line side of the transformer. However, the additional protection afforded by the transformer is lost, and the ability of the system to withstand high energy surges is limited to the capability of the protection device.

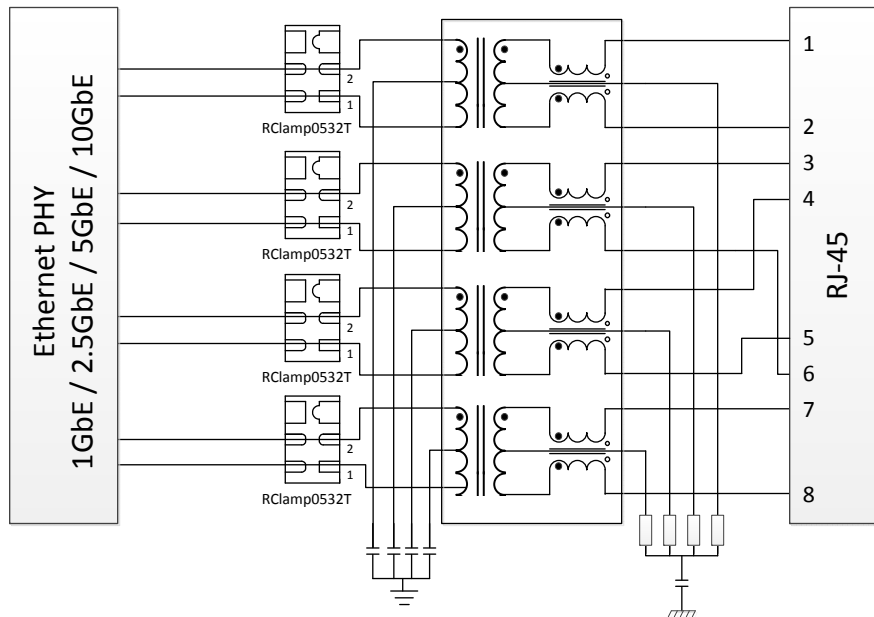
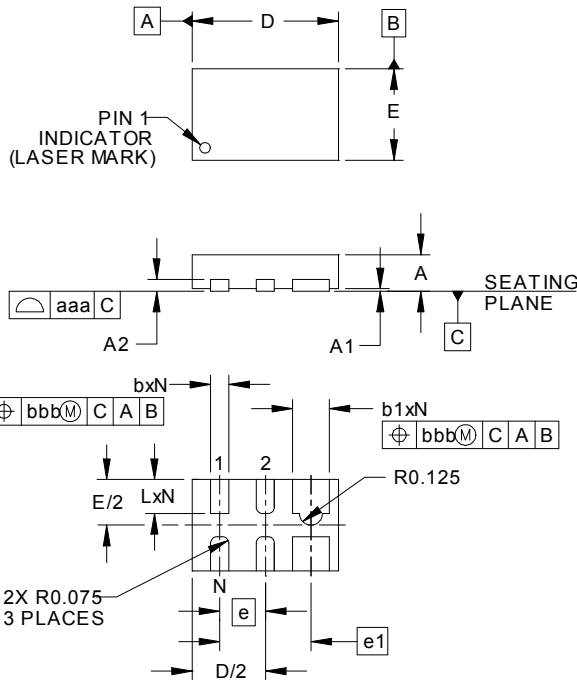

Figure 1 - Ethernet Protection Circuit

Outline Drawing - SLP1610P4T



DIM	INCHES			MILLIMETERS		
	MIN	NOM	MAX	MIN	NOM	MAX
A	.015	.016	.017	0.37	0.40	0.43
A1	0.00	.001	.002	0.00	0.03	0.05
A2	(.005)			(0.13)		
b	.006	.008	.010	0.15	0.20	0.25
b1	.014	.016	.018	0.35	0.40	0.45
D	.059	.063	.067	1.50	1.60	1.70
E	.035	.039	.043	0.90	1.00	1.10
e	.020 BSC			0.50 BSC		
e1	.039 BSC			1.00 BSC		
L	.012	.015	.017	0.30	0.38	0.43
N	4			4		
aaa	.003			0.08		
bbb	.004			0.10		

NOTES:
1. CONTROLLING DIMENSIONS ARE IN MILLIMETERS (ANGLES IN DEGREES).

Land Pattern - SLP1610P4T

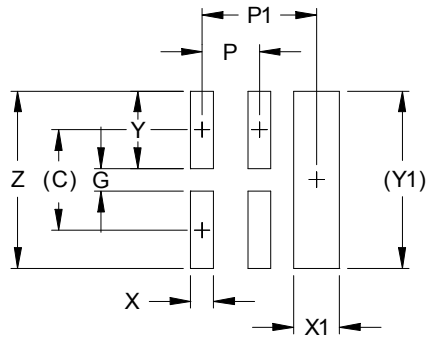

DIM	DIMENSIONS	
	INCHES	MILLIMETERS
C	(.034)	(0.875)
G	.008	0.20
P	.020	0.50
P1	.039	1.00
X	.008	0.20
X1	.016	0.40
Y	.027	0.675
Y1	(.061)	(1.55)
Z	.061	1.55

NOTES:
1. CONTROLLING DIMENSIONS ARE IN MILLIMETERS (ANGLES IN DEGREES).
2. THIS LAND PATTERN IS FOR REFERENCE PURPOSES ONLY.
CONSULT YOUR MANUFACTURING GROUP TO ENSURE YOUR COMPANY'S MANUFACTURING GUIDELINES ARE MET.

Marking Code

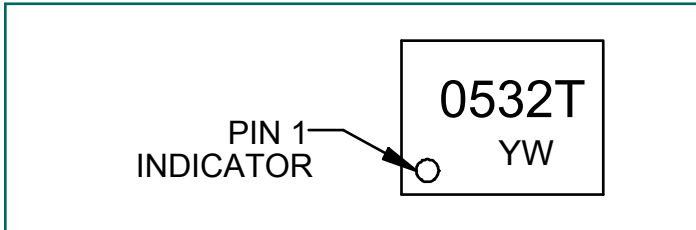

Notes: Dot indicates Pin 1 Location

Tape and Reel Specification

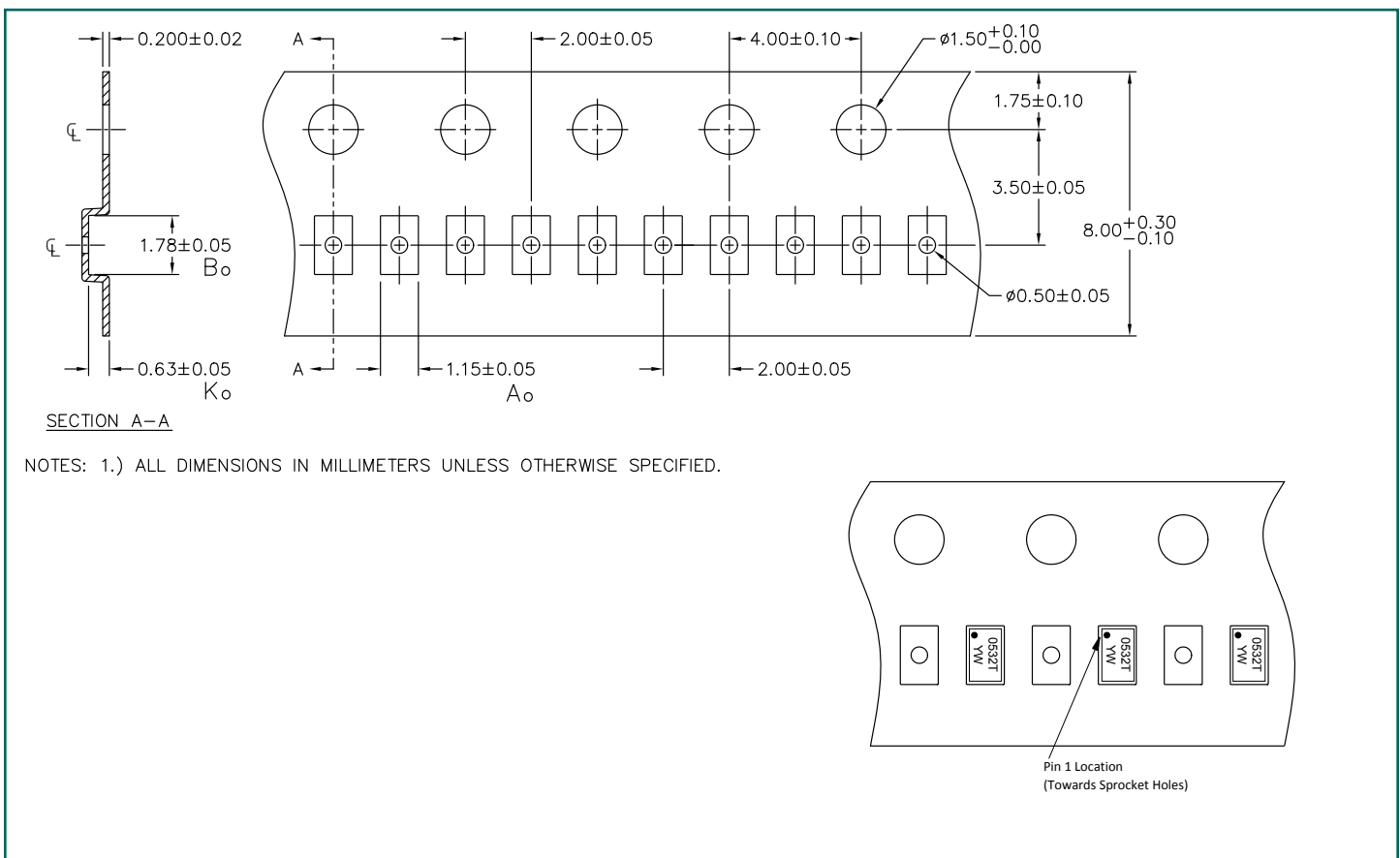

Ordering Information

Part Number	Qty per Reel	Reel Size	Carrier Tape	Device Pitch ¹
RClamp0532T.TCT	3000	7 Inch	Plastic	4mm
Notes				
1) Tape pocket pitch is 2mm. Every other pocket populated				
2) RailClamp and RClamp are registered trademarks of Semtech Corporation.				



IMPORTANT NOTICE

Information relating to this product and the application or design described herein is believed to be reliable, however such information is provided as a guide only and Semtech assumes no liability for any errors in this document, or for the application or design described herein. Semtech reserves the right to make changes to the product or this document at any time without notice. Buyers should obtain the latest relevant information before placing orders and should verify that such information is current and complete. Semtech warrants performance of its products to the specifications applicable at the time of sale, and all sales are made in accordance with Semtech's standard terms and conditions of sale.

SEMTECH PRODUCTS ARE NOT DESIGNED, INTENDED, AUTHORIZED OR WARRANTED TO BE SUITABLE FOR USE IN LIFE-SUPPORT APPLICATIONS, DEVICES OR SYSTEMS, OR IN NUCLEAR APPLICATIONS IN WHICH THE FAILURE COULD BE REASONABLY EXPECTED TO RESULT IN PERSONAL INJURY, LOSS OF LIFE OR SEVERE PROPERTY OR ENVIRONMENTAL DAMAGE. INCLUSION OF SEMTECH PRODUCTS IN SUCH APPLICATIONS IS UNDERSTOOD TO BE UNDERTAKEN SOLELY AT THE CUSTOMER'S OWN RISK. Should a customer purchase or use Semtech products for any such unauthorized application, the customer shall indemnify and hold Semtech and its officers, employees, subsidiaries, affiliates, and distributors harmless against all claims, costs damages and attorney fees which could arise.

The Semtech name and logo are registered trademarks of the Semtech Corporation. All other trademarks and trade names mentioned may be marks and names of Semtech or their respective companies. Semtech reserves the right to make changes to, or discontinue any products described in this document without further notice. Semtech makes no warranty, representation or guarantee, express or implied, regarding the suitability of its products for any particular purpose. All rights reserved.

© Semtech 2015

Contact Information

Semtech Corporation
200 Flynn Road, Camarillo, CA 93012
Phone: (805) 498-2111, Fax: (805) 498-3804
www.semtech.com