

**FEATURES**

- DC-coupled, 50  $\Omega$  matched output**
- Up to 4.3 dBm output power, -9.5 dBm at 9 GHz**
- DAC core update rate: 12.0 GSPS (guaranteed minimum) in 2 $\times$  NRZ mode**
- Wide analog bandwidth**
  - DC to 9.0 GHz in 2 $\times$  NRZ mode (12.0 GSPS DAC update rate)**
  - 1.0 GHz to 8.0 GHz in mix mode (6.0 GSPS DAC update rate)**
  - DC to 4.5 GHz in NRZ mode (6.0 GSPS DAC update rate)**
- Power dissipation of 4.88 W in 2 $\times$  NRZ mode (10 GSPS DAC update rate)**
- Bypassable datapath interpolation**
  - 2 $\times$ , 3 $\times$ , 4 $\times$ , 6 $\times$ , 8 $\times$ , 12 $\times$ , 16 $\times$ , 24 $\times$**
- Instantaneous (complex) signal bandwidth**
  - 2.25 GHz with device clock at 5 GHz (2 $\times$  interpolation)**
  - 1.8 GHz with device clock at 6 GHz (3 $\times$  interpolation)**
- Fast frequency hopping**
- Integrated BiCMOS buffer amplifier**

**APPLICATIONS**

- Instrumentation: automated test equipment, electronic test and measurement, arbitrary waveform generators**
- Electronic warfare: radars, jammers**
- Broadband communications systems**
- Local oscillator drivers**

**GENERAL DESCRIPTION**

The AD9166<sup>1</sup> is a high performance, wideband, on-chip vector signal generator composed of a high speed JESD204B serializer/deserializer (SERDES) interface, a flexible 16-bit digital datapath, a inphase/quadrature (I/Q) digital-to-analog converter (DAC) core, and an integrated differential to single-ended output buffer amplifier, matched to a 50  $\Omega$  load up to 10 GHz.

The DAC core is based on a quad-switch architecture, which is configurable to increase the effective DAC core update rate of up to 12.8 GSPS from a 6.4 GHz DAC sampling clock, with an analog output bandwidth of true dc to 9.0 GHz, typically. The digital datapath includes multiple interpolation filter stages, a direct digital synthesizer (DDS) block with multiple numerically controlled oscillators (NCOs) supporting fast frequency hopping (FFH), and additional FIR85 and inverse sinc filter stages to allow flexible spectrum planning.

The differential to single-ended buffer eliminates the need for a wideband balun, and supports the full analog output bandwidth of the DAC core. DC coupling the output allows baseband wave-

form generation without the need for external bias tees or similar circuitry, which makes the AD9166 uniquely suited for the most demanding high speed ultrawideband RF transmit applications.

The various filter stages enable the AD9166 to be configured for lower data rates, while maintaining higher DAC clock rates to ease the filtering requirements and reduce the overall system size, weight, and power.

The data interface receiver consists of up to eight JESD204B SERDES lanes, each capable of carrying up to 12.5 Gbps. To enable maximum flexibility, the receiver is fully configurable according to the data rate, number of SERDES lanes, and lane mapping required by the JESD204B transmitter.

In 2 $\times$  nonreturn-to-zero (NRZ) mode of operation (with FIR85 enabled), the AD9166 can reconstruct RF carriers from true dc to the edge of the third Nyquist zone, or an analog bandwidth of true dc up to 9 GHz.

In mix mode, the AD9166 can reconstruct RF carriers in the second and third Nyquist zones while consuming lower power and maintaining a performance comparable to 2 $\times$  NRZ mode.

In baseband modes, such as return-to-zero (RZ) and 1 $\times$  NRZ, the AD9166 is ideal to reconstruct RF carriers from true dc to the edge of the first Nyquist zone while consuming lower power compared to 2 $\times$  NRZ mode.

The quadrature DDS block can be configured as a digital upconverter to upconvert I/Q data samples to the desired location across the spectrum, in all three Nyquist zones.

The DDS also consists of a bank of 32 numerically controlled oscillators (NCOs), each with its own 32-bit phase accumulator. When combined with a 100 MHz serial peripheral interface (SPI), the DDS allows a phase coherent FFH, with a phase settling time as low as 300 ns.

The AD9166 is configured using a common SPI interface that monitors the status of all registers. The AD9166 is offered in a 324-ball, 15 mm  $\times$  15 mm, 0.8 mm pitch BGA\_ED package.

**PRODUCT HIGHLIGHTS**

1. High dynamic range and signal reconstruction bandwidth supports RF signal synthesis of up to 9 GHz.
2. Fully supports zero IF and other dc-coupled applications.
3. Up to an eight-lane JESD204B SERDES interface, with various features to allow flexibility when interfacing to a JESD204B transmitter.

<sup>1</sup> Protected by U.S. Patents 6,842,132 and 7,796,971.

## TABLE OF CONTENTS

Features .....	1	JESD204B Overview .....	29
Applications .....	1	Physical Layer .....	31
General Description .....	1	Data Link Layer .....	34
Product Highlights .....	1	Transport Layer .....	42
Revision History .....	2	JESD204B Test Modes .....	44
Functional Block Diagram .....	3	JESD204B Error Monitoring .....	46
Specifications .....	4	Hardware Considerations .....	48
DC Specifications .....	4	Main Digital Datapath .....	49
Power Supply DC Specifications .....	5	Data Format .....	49
Device Input Clock Rate and DAC Update Rate Specifications .....	7	Interpolation Filters .....	49
JESD204B Interface Specifications .....	8	Digital Modulation .....	52
Input Data Rate and Bandwidth Specifications .....	9	Inverse Sinc .....	55
Pipeline Delay and Latency Uncertainty Specifications .....	9	Downstream Protection .....	55
AC Specifications .....	10	Datapath PRBS .....	56
CMOS Pin Specifications .....	11	Datapath PRBS IRQ .....	56
Timing Specifications .....	12	Interrupt Request Operation .....	57
Absolute Maximum Ratings .....	14	Interrupt Service Routine .....	57
Reflow Profile .....	14	Applications Information .....	58
Thermal Management .....	14	Hardware Considerations .....	58
Thermal Resistance .....	14	Analog Interface Considerations .....	61
ESD Caution .....	14	Analog Modes of Operation .....	61
Pin Configuration and Function Descriptions .....	15	Clock Input .....	62
Typical Performance Characteristics .....	18	Shuffle Mode .....	63
AC Performance (2× NRZ (FIR85) Mode) .....	18	Voltage Reference and Full-Scale Current (FSC) .....	63
LTE Performance (2× NRZ (FIR85) Mode) .....	23	Analog Output .....	64
802.11AC Performance (2× NRZ (FIR85) Mode) .....	24	Temperature Sensors .....	65
Terminology .....	25	Start-Up Sequence .....	67
Theory of Operation .....	26	Register Summary: DAC .....	70
Serial Port Operation .....	27	Register Details: DAC Register Map .....	79
Data Format .....	27	Register Summary: Amplifier .....	135
Serial Port Pin Descriptions .....	27	Register Details: Amplifier Register Map .....	136
Serial Port Options .....	28	Outline Dimensions .....	138
JESD204B Serial Data Interface .....	29	Ordering Guide .....	138

## REVISION HISTORY

7/2020—Revision 0: Initial Version

# FUNCTIONAL BLOCK DIAGRAM

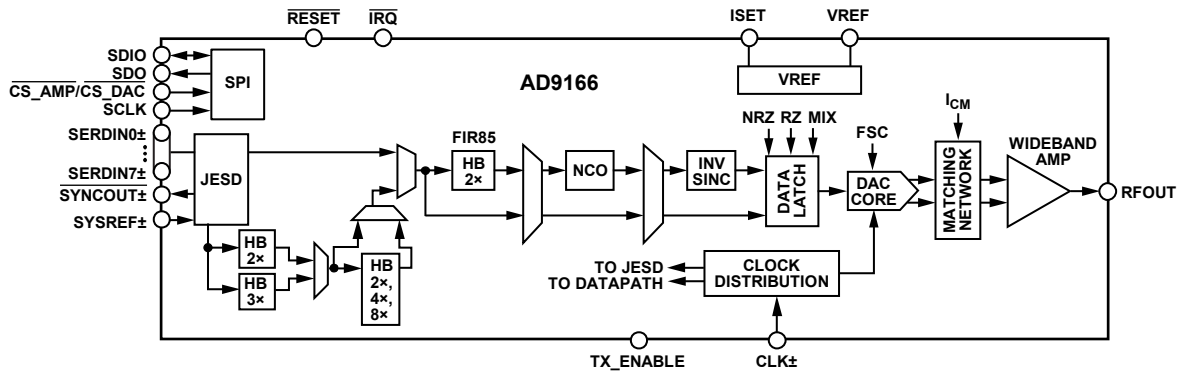

- NOTES
1. FSC IS FULL-SCALE CURRENT.
  2.  $I_{CM}$  IS THE INPUT COMMON-MODE CURRENT OF THE BUFFER AMPLIFIER.

Figure 1.

20810-001

## SPECIFICATIONS

### DC SPECIFICATIONS

DAC\_2P5\_AN = 2.5 V, DAC\_1P2\_AN = DAC\_1P2\_CLK = 1.2 V, DAC\_N1P2\_AN = -1.2 V, DAC\_1P2\_DIG = 1.2 V, VDD\_IO = 2.5 V, DAC\_1P2\_SER = 1.2 V, DAC\_3P3\_SYNC = 3.3 V, AMP\_5V\_IN = 5.0 V, AMP\_3P3\_OUT = 3.3 V, AMP\_3P3 = 3.3 V, AMP\_N5 = -5.0 V, DAC output full-scale current ( $I_{OUTFS}$ ) = 40 mA, and  $T_A$  = -40°C to +85°C, unless otherwise noted. 50  $\Omega$  matched output.

Table 1.

Parameter	Test Conditions/Comments	Min	Typ	Max	Unit
RESOLUTION		16			Bits
DAC ANALOG OUTPUT					
Power-Up Delay	From DAC output off to enabled		10		ns
Gain Error (with Internal Reference)			-1.7		%
Full-Scale Output Current ( $I_{OUTFS}$ )					
Minimum	DAC reference current setting resistor ( $R_{SET}$ ) = 9.76 k $\Omega$	7.37	8	8.57	mA
Maximum	$R_{SET}$ = 9.76 k $\Omega$	35.8	38.76	41.3	mA
AMPLIFIER ANALOG OUTPUT					
Maximum Full-Scale Power	Measured with full-scale output current set to its typical maximum				
DC			4.3		dBm
9 GHz	FIR85 enabled (2x NRZ)		-9.5		dBm
DEVICE CLOCK INPUT (CLK+, CLK-)					
Differential Input Power	Load resistance ( $R_{LOAD}$ ) = 90 $\Omega$ differential on chip	-20	0	+10	dBm
Common-Mode Voltage	AC-coupled		0.6		V
Input Impedance <sup>1</sup>	3 GSPS input clock		90		$\Omega$
Maximum Input Frequency ( $f_{CLK}$ )	See Table 3 for more details		6400		MHz
TEMPERATURE SENSOR					
Amplifier Sensor Accuracy <sup>2</sup>			$\pm 5$		°C
DAC Sensor Accuracy <sup>3</sup>			$\pm 5$		°C
ANALOG SUPPLY VOLTAGES					
DAC_2P5_AN		2.375	2.5	2.625	V
DAC_1P2_AN <sup>4</sup>		1.14	1.2	1.326	V
DAC_1P2_CLK <sup>4</sup>		1.14	1.2	1.326	V
DAC_N1P2_AN		-1.26	-1.2	-1.14	V
AMP_5V_IN		4.75	5	5.25	V
AMP_3P3_OUT		3.135	3.3	3.465	V
AMP_N5		-5.25	-5	-4.75	V
AMP_3P3		3.135	3.3	3.465	V
DIGITAL SUPPLY VOLTAGES					
DAC_1P2_DIG		1.14	1.2	1.326	V
VDD_IO <sup>5</sup>		1.71	2.5	3.465	V
SERDES SUPPLY VOLTAGES					
DAC_1P2_SER		1.14	1.2	1.326	V
DAC_3P3_SYNC		3.135	3.3	3.465	V

<sup>1</sup> See the Clock Input section for more details.

<sup>2</sup> The temperature sensor of the amplifier is a more accurate representation of  $T_J$ , but requires one-point calibration.

<sup>3</sup> Do not use the DAC temperature sensor reading to monitor  $T_J$ . Use as a reference only.

<sup>4</sup> For the lowest noise performance, use a separate power supply filter network for the DAC\_1P2\_CLK and the DAC\_1P2\_AN pins.

<sup>5</sup> VDD\_IO can range from 1.8 V to 3.3 V, with  $\pm 5\%$  tolerance.

**POWER SUPPLY DC SPECIFICATIONS**

$I_{OUTPS} = 40 \text{ mA}$ ,  $T_A = -40^\circ\text{C}$  to  $+85^\circ\text{C}$ , unless otherwise noted. FIR85 is the finite impulse response with 85 dB digital attenuation.

**Table 2.**

Parameter	Test Conditions/Comments	Min	Typ	Max	Unit
8 LANES, 2x INTERPOLATION (80%), 3 GSPS	NCO on, FIR85 on				
Analog Supply Currents					
DAC_2P5_AN			53.5	57	mA
DAC_1P2_AN			1	111	$\mu\text{A}$
DAC_1P2_CLK			239	255	mA
DAC_N1P2_AN		-117	-111.1		mA
AMP_5V_IN			169.9	182	mA
AMP_3P3_OUT			65.1	70.7	mA
AMP_N5			187.8	209	mA
AMP_3P3			21.2	23	mA
Digital Supply Currents					
DAC_1P2_DIG			545	611	mA
VDD_IO <sup>1</sup>	VDD_IO = 2.5 V		2.5	2.7	mA
DAC_1P2_SER			567.4	627	mA
DAC_3P3_SYNC			9.1	11	mA
8 LANES, 6x INTERPOLATION (80%), 3 GSPS	NCO on, FIR85 on				
Analog Supply Currents					
DAC_2P5_AN			53.5		mA
DAC_1P2_AN			1.4		$\mu\text{A}$
DAC_1P2_CLK			238.1		mA
DAC_N1P2_AN			-111.1		mA
AMP_5V_IN			169.7		mA
AMP_3P3_OUT			65.0		mA
AMP_N5			195.1		mA
AMP_3P3			21.1		mA
Digital Supply Currents					
DAC_1P2_DIG			632.4		mA
VDD_IO <sup>1</sup>	VDD_IO = 2.5 V		0.025		mA
DAC_1P2_SER			614.2		mA
DAC_3P3_SYNC			9.2		mA
NCO ONLY MODE, 5 GSPS					
Analog Supply Currents					
DAC_2P5_AN			47.6	63	mA
DAC_1P2_AN			0	109	$\mu\text{A}$
DAC_1P2_CLK			359	382	mA
DAC_N1P2_AN		-120	-104.9		mA
AMP_5V_IN			169.7	182	mA
AMP_3P3_OUT			65.1	71	mA
AMP_N5			194.9	216	mA
AMP_3P3			21.1	23	mA
Digital Supply Currents					
DAC_1P2_DIG			446.9	493	mA
VDD_IO <sup>1</sup>	VDD_IO = 2.5 V		2.5	2.7	mA
DAC_1P2_SER			3.0	8.5	mA
DAC_3P3_SYNC			0.34	0.44	mA
8 LANES, 4x INTERPOLATION (80%), 5 GSPS	NCO on, FIR85 off (unless otherwise noted for this test)				
Analog Supply Currents					
DAC_2P5_AN			55.5	59	mA
DAC_1P2_AN			0.1	123	$\mu\text{A}$
DAC_1P2_CLK			358.9	382	mA
DAC_N1P2_AN		-126	-120.0		mA
AMP_5V_IN			166.8	178	mA

Parameter	Test Conditions/Comments	Min	Typ	Max	Unit
AMP_3P3_OUT			65.1	71	mA
AMP_N5			185.9	207	mA
AMP_3P3			21.3	23	mA
Digital Supply Currents					
VDD_IO <sup>1</sup>	VDD_IO = 2.5 V		2.5	2.7	mA
DAC_1P2_DIG	NCO on, FIR85 off		705.1	769	mA
	NCO off, FIR85 on		749.1	819	mA
	NCO on, FIR85 on		962.7	1044	mA
DAC_1P2_SER			541.6	586	mA
DAC_3P3_SYNC			9.2	11	mA
8 LANES, 4× INTERPOLATION (80%), 5.8 GSPS	NCO on, FIR85 on				
Analog Supply Currents					
DAC_2P5_AN			53.5	57	mA
DAC_1P2_AN			0	68	μA
DAC_1P2_CLK			406	430	mA
DAC_N1P2_AN		-117	-111.1		mA
AMP_5V_IN			169.6	182	mA
AMP_3P3_OUT			65.0	71	mA
AMP_N5			194.5	216	mA
AMP_3P3			21.2	23	mA
Digital Supply Currents					
VDD_IO <sup>1</sup>	VDD_IO = 2.5 V		2.5	2.7	mA
DAC_1P2_DIG			1090	1200	mA
DAC_1P2_SER			575.5	622	mA
DAC_3P3_SYNC			9.0	11	mA
8 LANES, 3× INTERPOLATION (80%), 4.5 GSPS	NCO on, FIR85 on				
Analog Supply Currents					
DAC_2P5_AN			53.5	57	mA
DAC_1P2_AN			0	68	μA
DAC_1P2_CLK			330.5	352	mA
DAC_N1P2_AN		-117	-111.1		mA
AMP_5V_IN			169.7	182	mA
AMP_3P3_OUT			65.0	71	mA
AMP_N5			195.0	216	mA
AMP_3P3			21.2	23	mA
Digital Supply Currents					
VDD_IO <sup>1</sup>	VDD_IO = 2.5 V		2.5		mA
DAC_1P2_DIG			1025.1	1115	mA
DAC_1P2_SER			579.4	626	mA
DAC_3P3_SYNC			9.2	11	mA
POWER DISSIPATION					
Amplifier, Standalone			2.33	2.43	W
DAC, Standalone, 3 GSPS					
2× NRZ Mode, 6×, FIR85 Enabled, NCO On	Using 80%, 3× filter, eight-lane JESD204B		2.0	2.21	W
NRZ Mode, 24×, FIR85 Disabled, NCO On	Using 80%, 2× filter, one-lane JESD204B		1.2	1.31	W
DAC, Standalone, 5 GSPS					
NRZ Mode, 8×, FIR85 Disabled, NCO On	Using 80%, 2× filter, eight-lane JESD204B		2.08	2.30	W
NRZ Mode, 16×, FIR85 Disabled, NCO On	Using 80%, 2× filter, eight-lane JESD204B		1.99	2.18	W
DAC, Standalone, 10 GSPS					
2× NRZ Mode, 6×, FIR85 Enabled, NCO On	Using 80%, 3× filter, eight-lane JESD204B		2.55	2.85	W
Total, Amplifier and DAC, 10 GSPS	Using 80%, 3× filter, eight-lane JESD204B		4.88		W

<sup>1</sup> VDD\_IO can range from 1.8 V to 3.3 V, with ±5% tolerance.

**DEVICE INPUT CLOCK RATE AND DAC UPDATE RATE SPECIFICATIONS**

DAC\_2P5\_AN = 2.5 V, DAC\_1P2\_AN = DAC\_1P2\_CLK = 1.2 V, DAC\_N1P2\_AN = -1.2 V, DAC\_1P2\_DIG = 1.2 V, VDD\_IO = 2.5 V, DAC\_1P2\_SER = 1.2 V, DAC\_3P3\_SYNC = 3.3 V, AMP\_5V\_IN = 5.0 V, AMP\_3P3\_OUT = 3.3 V, AMP\_3P3 = 3.3 V, AMP\_N5 = -5.0 V, I<sub>OUTFS</sub> = 40 mA, T<sub>A</sub> = -40°C to +85°C, unless otherwise noted.

Maximum guaranteed speed using the temperature and voltage conditions shown in Table 3, where DAC\_1P2\_x includes DAC\_1P2\_AN, DAC\_1P2\_CLK, DAC\_1P2\_DIG, and DAC\_1P2\_SER. Any device clock speed over 5.1 GHz requires a maximum junction temperature not exceeding 105°C to avoid damage to the device. See Table 11 for details on maximum junction temperature permitted for certain clock speeds.

**Table 3.**

Parameter	Test Conditions/Comments <sup>1</sup>	Min	Typ	Max	Unit
MAXIMUM INPUT CLOCK RATE (f <sub>CLK</sub> )					
DAC_1P2_x = 1.2 V ± 5%	T <sub>J,DAC,MAX</sub> = 25°C	6.0			GHz
	T <sub>J,DAC,MAX</sub> = 85°C	5.6			GHz
	T <sub>J,DAC,MAX</sub> = 105°C	5.4			GHz
DAC_1P2_x = 1.2 V ± 2%	T <sub>J,DAC,MAX</sub> = 25°C	6.1			GHz
	T <sub>J,DAC,MAX</sub> = 85°C	5.8			GHz
	T <sub>J,DAC,MAX</sub> = 105°C	5.6			GHz
DAC_1P2_x = 1.3 V ± 2%	T <sub>J,DAC,MAX</sub> = 25°C	6.4			GHz
	T <sub>J,DAC,MAX</sub> = 85°C	6.2			GHz
	T <sub>J,DAC,MAX</sub> = 105°C	6.0			GHz
DAC UPDATE RATE (f <sub>DAC</sub> )					
Minimum				1.5	GSPS
Maximum	DAC_1P2_x = 1.3 V ± 2%	6	6.4		GSPS
	DAC_1P2_x = 1.3 V ± 2%, FIR85 (2× NRZ) enabled	12	12.8		GSPS
Adjusted <sup>2</sup>	DAC_1P2_x = 1.3 V ± 2%	6	6.4		GSPS

<sup>1</sup> T<sub>J,DAC,MAX</sub> is the maximum junction temperature measured using the DAC temperature sensor.

<sup>2</sup> The adjusted DAC update rate is calculated as follows: when FIR85 is disabled, f<sub>DAC</sub> is divided by the minimum required interpolation factor. For the AD9166, the minimum interpolation factor is 1. Therefore, with f<sub>DAC</sub> = 6.0 GSPS, f<sub>DAC</sub> adjusted = 6.0 GSPS. When FIR85 is enabled, which puts the device into 2× NRZ mode, f<sub>DAC</sub> = 2 × f<sub>CLK</sub>, and the minimum interpolation is 2× (interpolation value). Thus, for the AD9166, with FIR85 enabled and f<sub>CLK</sub> = 6 GHz, f<sub>DAC</sub> = 12.0 GSPS, minimum interpolation = 2×, and the adjusted DAC update rate = 6.0 GSPS.

**JESD204B INTERFACE SPECIFICATIONS**

DAC\_2P5\_AN = 2.5 V, DAC\_1P2\_AN = DAC\_1P2\_CLK = 1.2 V, DAC\_N1P2\_AN = -1.2 V, DAC\_1P2\_DIG = 1.2 V, VDD\_IO = 2.5 V, DAC\_1P2\_SER = 1.2 V, DAC\_3P3\_SYNC = 3.3 V, AMP\_5V\_IN = 5.0 V, AMP\_3P3\_OUT = 3.3 V, AMP\_3P3 = 3.3 V, AMP\_N5 = -5.0 V, I<sub>OUTFS</sub> = 40 mA, T<sub>A</sub> = -40°C to +85°C, unless otherwise noted. V<sub>TT</sub> is the termination voltage.

**Table 4.**

Parameter	Symbol	Test Conditions/Comments	Min	Typ	Max	Unit
SERIAL INTERFACE SPEED		Guaranteed operating range per each lane				
Half Rate			6		12.5	Gbps
Full Rate			3		6.25	Gbps
Oversampling			1.5		3.125	Gbps
2x Oversampling			0.750		1.5625	Gbps
JESD204B DATA INPUTS						
Input Leakage Current		T <sub>A</sub> = 25°C				
Logic High		Input level = 1.2 V ± 0.25 V, V <sub>TT</sub> = 1.2 V		10		μA
Logic Low		Input level = 0 V		-4		μA
Unit Interval	UI		80		1333	ps
Common-Mode Voltage	V <sub>RCM</sub>	AC-coupled, V <sub>TT</sub> = DAC_1P2_SER <sup>1</sup>	-0.05		+1.85	V
Differential Voltage	V <sub>DIFF</sub>		110		1050	mV
V <sub>TT</sub> Source Impedance	Z <sub>TT</sub>	At dc			30	Ω
Differential Impedance	Z <sub>RDIFF</sub>	At dc	80	100	120	Ω
Differential Return Loss	RL <sub>RDIF</sub>			8		dB
Common-Mode Return Loss	RL <sub>RCM</sub>			6		dB
SYSREF± INPUT						
Differential Impedance				121		Ω
DIFFERENTIAL OUTPUTS (SYNCOUT±) <sup>2</sup>		Driving 100 Ω differential load				
Output Differential Voltage	V <sub>OD</sub>		350	420	450	mV
Output Offset Voltage	V <sub>OS</sub>		1.15	1.2	1.27	V

<sup>1</sup> As measured on the input side of the ac coupling capacitor.

<sup>2</sup> IEEE Standard 1596.3 LVDS compatible.



## INPUT DATA RATE AND BANDWIDTH SPECIFICATIONS

DAC\_2P5\_AN = 2.5 V, DAC\_1P2\_AN = DAC\_1P2\_CLK = 1.2 V, DAC\_N1P2\_AN = -1.2 V, DAC\_1P2\_DIG = 1.2 V, VDD\_IO = 2.5 V, DAC\_1P2\_SER = 1.2 V, DAC\_3P3\_SYNC = 3.3 V, AMP\_5V\_IN = 5.0 V, AMP\_3P3\_OUT = 3.3 V, AMP\_3P3 = 3.3 V, AMP\_N5 = -5.0 V, I<sub>OUTFS</sub> = 40 mA, T<sub>A</sub> = -40°C to +85°C, unless otherwise noted.

Table 5.

Parameter	Test Conditions/Comments	Min	Typ	Max	Unit
INPUT DATA RATE					
Complex <sup>1</sup>	Interpolation > 1×	0.15		2.5	GSPS
Real	Interpolation = 1×	0.3		5.0	GSPS
INSTANTANEOUS SIGNAL BANDWIDTH <sup>2</sup>					
Complex	f <sub>CLK</sub> = 5 GHz, interpolation = 2×			2.25	GHz
	f <sub>CLK</sub> = 6 GHz, interpolation = 3×			1.8	GHz
Real	f <sub>CLK</sub> = 5 GHz, interpolation = 1×			2.5	GHz
ANALOG BANDWIDTH					
2x NRZ (FIR85 Enabled)	f <sub>DAC</sub> = 12.0 GSPS				
Minimum			DC		GHz
Maximum			9.0		GHz
Mix Mode (FIR85 Disabled)	f <sub>DAC</sub> = 6.0 GSPS				
Minimum			1.0		GHz
Maximum			8.0		GHz
NRZ (FIR85 Disabled)	f <sub>DAC</sub> = 6.0 GSPS				
Minimum			DC		GHz
Maximum <sup>3</sup>			4.5		GHz

<sup>1</sup> The complex data rate is the combined rate for both I and Q.

<sup>2</sup> Interpolation filter bandwidth set to 90%.

<sup>3</sup> Limited by the available output power due to sinc roll-off. See Figure 88 for more details.

## PIPELINE DELAY AND LATENCY UNCERTAINTY SPECIFICATIONS

DAC\_2P5\_AN = 2.5 V, DAC\_1P2\_AN = DAC\_1P2\_CLK = 1.2 V, DAC\_N1P2\_AN = -1.2 V, DAC\_1P2\_DIG = 1.2 V, VDD\_IO = 2.5 V, DAC\_1P2\_SER = 1.2 V, DAC\_3P3\_SYNC = 3.3 V, AMP\_5V\_IN = 5.0 V, AMP\_3P3\_OUT = 3.3 V, AMP\_3P3 = 3.3 V, AMP\_N5 = -5.0 V, I<sub>OUTFS</sub> = 40 mA, T<sub>A</sub> = -40°C to +85°C, unless otherwise noted.

Table 6.

Parameter <sup>1</sup>	Test Conditions/Comments	Min	Typ	Max	Unit
JESD204B LINK LATENCY					
Fixed				12	PCLK <sup>2</sup> cycles
Variable				2	PCLK <sup>2</sup> cycles
JESD204B TO DATAPATH INTERFACE LATENCY			1		PCLK <sup>2</sup> cycle
DATAPATH PIPELINE DELAY <sup>3</sup>	NCO only, FIR85 off, inverse sinc off		48		f <sub>CLK</sub> cycles
SYSREF± to LOCAL MULTIFRAME CLOCKS (LMFC) DELAY	JED204B Subclass 1		4		f <sub>CLK</sub> cycles
DETERMINISTIC LATENCY UNCERTAINTY					
JED204B Subclass 0			32		f <sub>CLK</sub> cycles
JED204B Subclass 1 <sup>4</sup>				4	f <sub>CLK</sub> cycles

<sup>1</sup> The total latency through the device is calculated as follows:

*Total Latency = Fixed Latency + Variable Latency + Interface Latency + Datapath Pipeline Delay.*

<sup>2</sup> PCLK is the internal processing clock for the AD9166 and equals the lane rate ÷ 40.

<sup>3</sup> See Table 33 for pipeline delay (latency) values across different datapath configurations.

<sup>4</sup> The SYSREF± signal input is sampled at a rate of f<sub>CLK</sub>/4, which leads to up to 4 f<sub>CLK</sub> cycles of deterministic latency uncertainty, provided that the setup and hold times for sampling SYSREF± are met according to Table 10. The deterministic latency uncertainty can be further improved, using Register 0x037 and Register 0x038 to read the exact clock cycle that was used to sample SYSREF±. See the SYSREF± Signal section for more details.

**AC SPECIFICATIONS**

DAC\_2P5\_AN = 2.5 V, DAC\_1P2\_AN = DAC\_1P2\_CLK = 1.2 V, DAC\_N1P2\_AN = -1.2 V, DAC\_1P2\_DIG = 1.2 V, VDD\_IO = 2.5 V, DAC\_1P2\_SER = 1.2 V, DAC\_3P3\_SYNC = 3.3 V, AMP\_5V\_IN = 5.0 V, AMP\_3P3\_OUT = 3.3 V, AMP\_3P3 = 3.3 V, AMP\_N5 = -5.0 V.

I<sub>OUTFS</sub> = 20 mA, digital scale = 0 dBFS, f<sub>DAC</sub> = 12.0 GSPS, FIR85 enabled, T<sub>A</sub> = 25°C, unless otherwise noted. f<sub>OUT</sub> is output frequency.

**Table 7.**

Parameter	Test Conditions/Comments	Min	Typ	Max	Unit
SPURIOUS-FREE DYNAMIC RANGE (SFDR) <sup>1</sup>					
Single Tone					
f <sub>OUT</sub> = 51 MHz			-83		dBc
f <sub>OUT</sub> = 451 MHz			-66		dBc
f <sub>OUT</sub> = 1051 MHz			-54		dBc
f <sub>OUT</sub> = 2051 MHz			-46		dBc
f <sub>OUT</sub> = 4051 MHz			-38		dBc
f <sub>OUT</sub> = 6051 MHz			-42		dBc
f <sub>OUT</sub> = 9051 MHz			-35		dBc
Single Tone, I <sub>OUTFS</sub> = 40 mA					
f <sub>OUT</sub> = 51 MHz			-69		dBc
f <sub>OUT</sub> = 451 MHz			-55		dBc
f <sub>OUT</sub> = 1051 MHz			-43		dBc
f <sub>OUT</sub> = 2051 MHz			-33		dBc
f <sub>OUT</sub> = 4051 MHz			-25		dBc
f <sub>OUT</sub> = 6051 MHz			-29		dBc
f <sub>OUT</sub> = 9051 MHz			-20		dBc
ADJACENT CHANNEL LEAKAGE RATIO (ACLR)					
Single-Carrier Long-Term Evolution (LTE)	First adjacent channel, -6 dBFS				
f <sub>OUT</sub> = 849 MHz			-70		dBc
f <sub>OUT</sub> = 1865 MHz			-70		dBc
f <sub>OUT</sub> = 2150 MHz			-71		dBc
f <sub>OUT</sub> = 2680 MHz			-71		dBc
f <sub>OUT</sub> = 3380 MHz			-69		dBc
f <sub>OUT</sub> = 3680 MHz			-67		dBc
Single-Carrier IEEE 802.11AC	First adjacent channel				
f <sub>OUT</sub> = 5160 MHz			-60		dBc
f <sub>OUT</sub> = 5865 MHz			-59		dBc
INTERMODULATION DISTORTION (IMD)					
Two-Tone Test					
f <sub>OUT</sub> = 51 MHz			-78		dBc
f <sub>OUT</sub> = 451 MHz			-65		dBc
f <sub>OUT</sub> = 1051 MHz			-59		dBc
f <sub>OUT</sub> = 2051 MHz			-51		dBc
f <sub>OUT</sub> = 4051 MHz			-37		dBc
f <sub>OUT</sub> = 6051 MHz			-55		dBc
f <sub>OUT</sub> = 9051 MHz			-43		dBc
Two-Tone Test, I <sub>OUTFS</sub> = 40 mA					
f <sub>OUT</sub> = 51 MHz			-75		dBc
f <sub>OUT</sub> = 451 MHz			-60		dBc
f <sub>OUT</sub> = 1051 MHz			-55		dBc
f <sub>OUT</sub> = 2051 MHz			-49		dBc
f <sub>OUT</sub> = 4051 MHz			-31		dBc
f <sub>OUT</sub> = 6051 MHz			-38		dBc
f <sub>OUT</sub> = 9051 MHz			-32		dBc

Parameter	Test Conditions/Comments	Min	Typ	Max	Unit
NOISE SPECTRAL DENSITY (NSD)	Single tone, $I_{OUTFS} = 40$ mA				
$f_{OUT} = 537$ MHz			-157		dBc/Hz
$f_{OUT} = 1044$ MHz			-157		dBc/Hz
$f_{OUT} = 2062$ MHz			-157		dBc/Hz
$f_{OUT} = 3791$ MHz			-154		dBc/Hz
$f_{OUT} = 4095$ MHz			-157		dBc/Hz
$f_{OUT} = 5011$ MHz			-153		dBc/Hz
$f_{OUT} = 5926$ MHz			-150		dBc/Hz
SINGLE SIDEBAND PHASE NOISE AT OFFSET	$f_{OUT} = 3600$ MHz, $f_{DAC} = 12,042.24$ MSPS				
1 kHz Offset			-110.2		dBc/Hz
10 kHz Offset			-134.8		dBc/Hz
100 kHz Offset			-140.4		dBc/Hz
1 MHz Offset			-149.0		dBc/Hz
10 MHz Offset			-154.0		dBc/Hz

<sup>1</sup> See the Clock Input section for more details on optimizing SFDR and reducing the image of the fundamental with clock input tuning.

### CMOS PIN SPECIFICATIONS

DAC\_2P5\_AN = 2.5 V, DAC\_1P2\_AN = DAC\_1P2\_CLK = 1.2 V, DAC\_N1P2\_AN = -1.2 V, DAC\_1P2\_DIG = 1.2 V, VDD\_IO = 2.5 V, DAC\_1P2\_SER = 1.2 V, DAC\_3P3\_SYNC = 3.3 V, AMP\_5V\_IN = 5.0 V, AMP\_3P3\_OUT = 3.3 V, AMP\_3P3 = 3.3V, AMP\_N5 = -5.0 V,  $I_{OUTFS} = 40$  mA,  $T_A = -40^{\circ}\text{C}$  to  $+85^{\circ}\text{C}$ , unless otherwise noted. CS\_x refers to CS\_AMP and CS\_DAC.

Table 8.

Parameter	Symbol	Test Comments/Conditions	Min	Typ	Max	Unit
INPUTS (SDIO, SCLK, CS_x, RESET, TX_ENABLE)						
Voltage Input						
High	$V_{IH}$	$1.8\text{ V} \leq VDD\_IO \leq 2.5\text{ V}$	$0.7 \times VDD\_IO$			V
Low	$V_{IL}$	$1.8\text{ V} \leq VDD\_IO \leq 2.5\text{ V}$			$0.3 \times VDD\_IO$	V
Current Input						
High	$I_{IH}$				75	$\mu\text{A}$
Low	$I_{IL}$		-150			$\mu\text{A}$
OUTPUTS (SDIO, SDO)						
Voltage Output						
High	$V_{OH}$	$1.8\text{ V} \leq VDD\_IO \leq 3.3\text{ V}$	$0.8 \times VDD\_IO$			V
Low	$V_{OL}$	$1.8\text{ V} \leq VDD\_IO \leq 3.3\text{ V}$			$0.2 \times VDD\_IO$	V
Current Output						
High	$I_{OH}$			4		mA
Low	$I_{OL}$			4		mA

**TIMING SPECIFICATIONS****Serial Port**

DAC\_2P5\_AN = 2.5 V, DAC\_1P2\_AN = DAC\_1P2\_CLK = 1.2 V, DAC\_N1P2\_AN = -1.2 V, DAC\_1P2\_DIG = 1.2 V, VDD\_IO = 2.5 V, DAC\_1P2\_SER = 1.2 V, DAC\_3P3\_SYNC = 3.3 V, AMP\_5V\_IN = 5.0 V, AMP\_3P3\_OUT = 3.3 V, AMP\_3P3 = 3.3V, AMP\_N5 = -5.0 V, I<sub>OUTFS</sub> = 40 mA, T<sub>A</sub> = -40°C to +85°C, unless otherwise noted. CS\_x refers to CS\_AMP and CS\_DAC.

**Table 9.**

Parameter	Symbol	Test Comments/Conditions	Min	Typ	Max	Unit
<b>WRITE OPERATION</b>						
Maximum SCLK Clock Rate	f <sub>SCLK</sub> , 1/t <sub>SCLK</sub>	See Figure 47	100			MHz
SCLK Clock High	t <sub>PWH</sub>	SCLK = 20 MHz	2.1			ns
SCLK Clock Low	t <sub>PWL</sub>	SCLK = 20 MHz	4.3			ns
SDIO to SCLK Setup Time	t <sub>DS</sub>		2.6	2		ns
SCLK to SDIO Hold Time	t <sub>DH</sub>		3.5	1.5		ns
CS_x to SCLK Setup Time	t <sub>S</sub>		9	2.53		ns
SCLK to CS_x Hold Time	t <sub>H</sub>		9	6.7		ns
<b>READ OPERATION</b>						
SCLK Clock Rate	f <sub>SCLK</sub> , 1/t <sub>SCLK</sub>	See Figure 46			20	MHz
SCLK Clock High	t <sub>PWH</sub>	Not shown in Figure 46	20			ns
SCLK Clock Low	t <sub>PWL</sub>	Not shown in Figure 46	20			ns
SDIO to SCLK Setup Time	t <sub>DS</sub>	Not shown in Figure 46	10			ns
SCLK to SDIO Hold Time	t <sub>DH</sub>	Not shown in Figure 46	5			ns
CS_x to SCLK Setup Time	t <sub>S</sub>	Not shown in Figure 46	10			ns
SCLK to SDIO (or SDO) Data Valid Time	t <sub>DV</sub>				12	ns
CS_x to SDIO (or SDO) Output Valid to High-Z		Not shown in Figure 46			21	ns

**SYSREF±**

DAC\_2P5\_AN = 2.5 V, DAC\_1P2\_AN = DAC\_1P2\_CLK = 1.2 V, DAC\_N1P2\_AN = -1.2 V, DAC\_1P2\_DIG = 1.2 V, VDD\_IO = 2.5 V, DAC\_1P2\_SER = 1.2 V, DAC\_3P3\_SYNC = 3.3 V, AMP\_5V\_IN = 5.0 V, AMP\_3P3\_OUT = 3.3 V, AMP\_3P3 = 3.3 V, AMP\_N5 = -5.0 V, I<sub>OUTFS</sub> = 40 mA, T<sub>A</sub> = -40°C to +85°C, unless otherwise noted.

**Table 10.**

Parameter	Test Conditions/Comments	Min	Typ	Max <sup>1</sup>	Unit
SYSREF± <sup>2</sup>					
Differential Swing = 1.0 V					
Minimum Setup Time, t <sub>SYSS</sub>	AC-coupled		65		ps
	DC-coupled, common-mode voltage = 0 V		45		ps
	DC-coupled, common-mode voltage = 1.25 V		68		ps
Minimum Hold Time, t <sub>SYSH</sub>	AC-coupled		19		ps
	DC-coupled, common-mode voltage = 0 V		5		ps
	DC-coupled, common-mode voltage = 1.25 V		51		ps

<sup>1</sup> The maximum setup and hold times can be inferred from the data sheet for the 11 mm × 11 mm variant of the AD9164, under the assumption that the variations due to difference in device laminate between the AD9166 and the AD9164 are minimal.

<sup>2</sup> The SYSREF± pulse must have a duration longer than the device sample and hold time, plus four additional device clock cycles. For more information, refer to the SYSREF± Signal section.

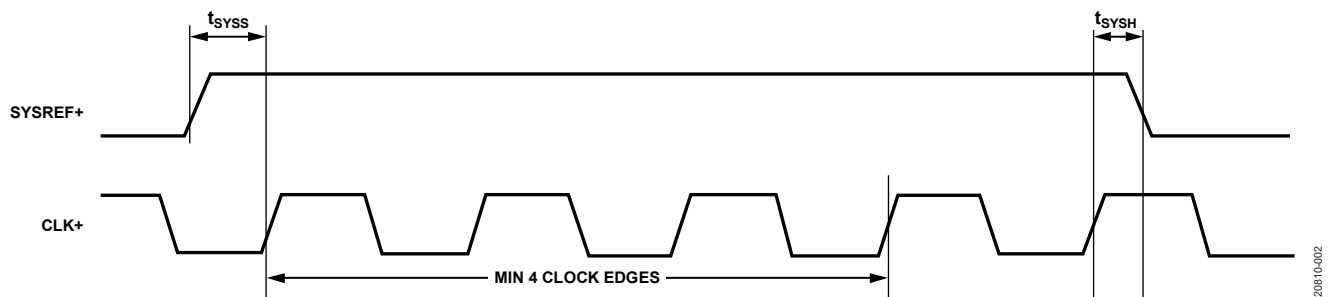

Figure 2. SYSREF± to Device Clock Timing Diagram (Only SYSREF+ and CLK+ Shown)

20810-002

## ABSOLUTE MAXIMUM RATINGS

Table 11.

Parameter	Rating
Supply Pins	
DAC_1P2_AN, DAC_1P2_CLK, DAC_1P2_DIG, DAC_1P2_SER to GND	−0.3 V to +1.326 V
DAC_2P5_AN to GND	−0.3 V to +2.625 V
DAC_N1P2_AN to GND	−1.26 V to +0.3 V
VDD_IO, DAC_3P3_SYNC, AMP_3P3_OUT, AMP_3P3 to GND	−0.3 V to +3.465 V
AMP_5V_IN to GND	−0.3 V to +5.25 V
AMP_N5 to GND	−5.25 V to +0.3 V
Input/Output Pins	
RESET, IRQ, CS_AMP, CS_DAC, SCLK, SDIO, SDO to GND	−0.3 V to VDD_IO + 0.3 V
SYNCOU $\pm$	−0.3 V to DAC_3P3_SYNC + 0.3 V
SERDIN $\times\pm$	−0.3 V to DAC_1P2_SER + 0.3 V
SYSREF $\pm$	−0.5 V to +2.5 V
CLK $\pm$ to GND	−0.3 V to DAC_1P2_CLK + 0.3 V
ISET, VREF to DAC_VBGNEG	−0.3 V to DAC_2P5_AN + 0.3 V
Junction Temperature <sup>1</sup>	
DAC Core (T <sub>J,DAC</sub> )	
f <sub>CLK</sub> > 5.1 GHz	105°C
f <sub>CLK</sub> ≤ 5.1 GHz	110°C
Amplifier (T <sub>J,AMP</sub> )	105°C
Peak Reflow	260°C
Storage Temperature Range	−65°C to +150°C

<sup>1</sup> Some operating modes of the device may cause the device to approach or exceed the maximum junction temperature during operation at supported ambient temperatures. Removal of heat from the device may require additional measures such as active airflow, heat sinks, or other measures.

Stresses at or above those listed under Absolute Maximum Ratings may cause permanent damage to the product. This is a stress rating only; functional operation of the product at these or any other conditions above those indicated in the operational section of this specification is not implied. Operation beyond the maximum operating conditions for extended periods may affect product reliability.

## REFLOW PROFILE

The AD9166 reflow profile is in accordance with the JEDEC JESD204B criteria for Pb-free devices. The maximum reflow temperature is 260°C.

## THERMAL MANAGEMENT

The AD9166 is a high-power device that can dissipate as much as 4.88 W depending on the user application and configuration. Due to the high power density of the AD9166, thermal management is required to avoid exceeding the maximum junction temperatures specified in Table 11, especially at elevated ambient temperatures in still air.

## THERMAL RESISTANCE

Thermal performance is directly linked to printed circuit board (PCB) design and operating environment. Careful attention to PCB thermal design is required.

$\theta_{JA}$  is the natural convection junction to ambient thermal resistance measured in a one cubic foot sealed enclosure.  $\theta_{JC}$  is the junction to case thermal resistance.

Table 12. Thermal Resistance

Package Type	$\theta_{JA}$	$\theta_{JC}$	Unit
BP-324-1 <sup>1</sup>	25.1	8.7	°C/W

<sup>1</sup> Thermal resistance values specified are simulated based on JEDEC specifications in compliance with JESD51-12.

## ESD CAUTION



### ESD (electrostatic discharge) sensitive device.

Charged devices and circuit boards can discharge without detection. Although this product features patented or proprietary protection circuitry, damage may occur on devices subjected to high energy ESD. Therefore, proper ESD precautions should be taken to avoid performance degradation or loss of functionality.

# PIN CONFIGURATION AND FUNCTION DESCRIPTIONS

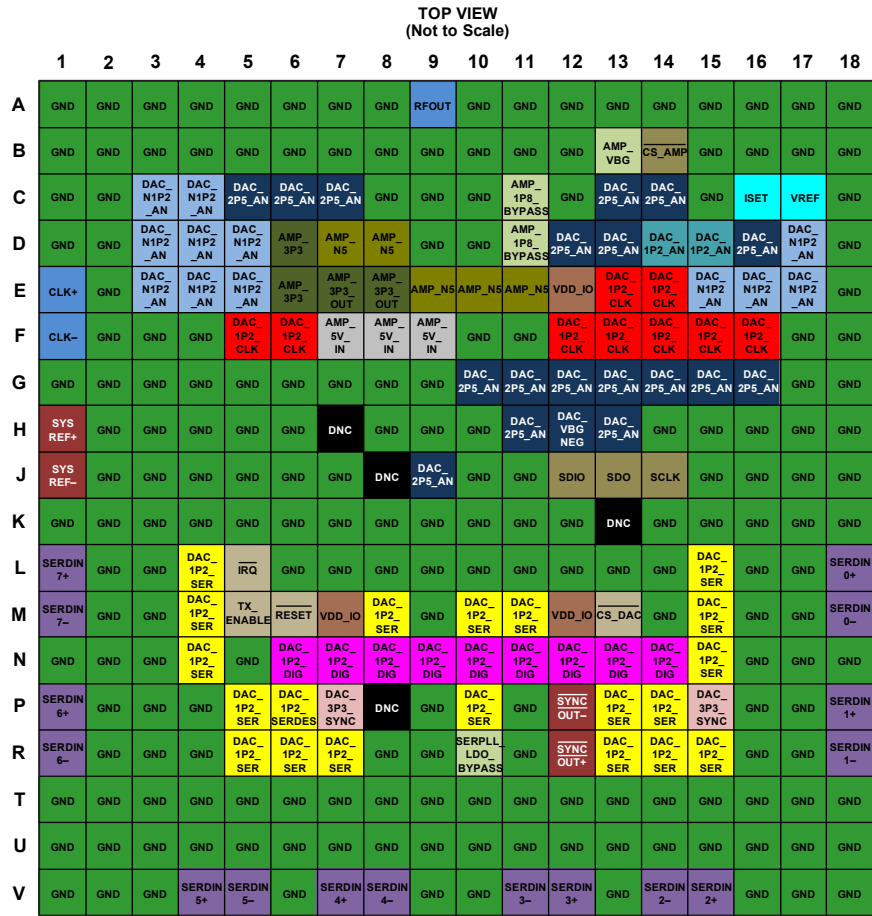

DNC = DO NOT CONNECT. LEAVE THESE PINS FLOATING.

	3.3V ANALOG SUPPLY, BUFFER OUTPUT		1.2V SERDES SUPPLY
	-5V ANALOG SUPPLY, BUFFER REFERENCE		1.2V DIGITAL SUPPLY
	5V ANALOG SUPPLY, BUFFER INPUT		I/O PINS SUPPLY (1.8V TO 3.3V)
	2.5V ANALOG SUPPLY, DAC OUTPUT		3.3V SYNCOUT+/SYNCOUT- SUPPLY
	-1.2V ANALOG SUPPLY, DAC OUTPUT		SERDES LANE x
	1.2V ANALOG SUPPLY, DAC CLOCK		SYSTEM REFERENCE POSITIVE AND NEGATIVE
	1.2V ANALOG SUPPLY, DAC MIXED-SIGNAL		RF SIGNALS
	CMOS I/O		BYPASS NODE
	GND REFERENCE		REFERENCE NODE
	DNC		

Figure 3. Pin Configuration

Table 13. Pin Function Descriptions

Pin No.	Mnemonic	Description
A1 to A8, A10 to A18, B1 to B12, B15 to B18, C1, C2, C8 to C10, C12, C15, C18, D1, D2, D9, D10, D18, E2, E18, F2 to F4, F10, F11, F17, F18, G1 to G9, G17, G18, H2 to H6, H8 to H10, H14 to H18, J2 to J7, J10, J11, J15 to J18, K1 to K12, K14 to K18, L2, L3, L6 to L14, L16, L17, M2, M3, M9, M14, M16, M17, N1 to N3, N5, N16 to N18, P2 to P4, P9, P11, P16, P17, R2 to R4, R8, R9, R11, R16, R17, T1 to T18, U1 to U18, V1 to V3, V6, V9, V10, V13, V16 to V18	GND	Ground.
A9	RFOUT	Device RF Output. Internally matched to a 50 Ω single-ended load impedance.

Pin No.	Mnemonic	Description
B13	AMP_VBG	Amplifier Band Gap Voltage. Connect Pin B13 to a 0.1 $\mu$ F capacitor to ground, and a 1 k $\Omega$ resistor in series with a 1 $\mu$ F capacitor to ground. For information about the voltage measured at this pin, $V_{BGA}$ , see the Amplifier Junction Temperature Sensor section.
B14	$\overline{CS\_AMP}$	Amplifier Serial Port Chip Select (Active Low) Input. CMOS levels on Pin B14 are determined with respect to VDD_IO.
C3, C4, D3 to D5, D17, E3 to E5, E15 to E17 C5 to C7, C13, C14, D12, D13, D16, G10 to G16, H11, H13, J9 C11, D11	DAC_N1P2_AN DAC_2P5_AN	-1.2 V Analog Supply Voltage. 2.5 V Analog Supply Voltage.
C16	AMP_1P8_BYPASS	Bypass Node for Internal 1.8 V Analog Supply. Short Pin C11 and Pin D11 and connect a 1 $\mu$ F capacitor to ground.
C17	ISET	DAC Reference Current. Connect Pin C16 with a 9.76 k $\Omega$ resistor ( $R_{SET}$ ) to DAC_N1P2_AN.
D6, E6 D7, D8, E9, E10, E11 D14, D15 E1, F1	VREF AMP_3P3 AMP_N5 DAC_1P2_AN CLK+, CLK-	DAC 1.2 V Reference Input/Output. Connect Pin C17 with a 1 $\mu$ F capacitor to ground. 3.3 V Analog Supply Voltage. -5 V Analog Supply Voltage. 1.2 V Analog Supply Voltage. Positive and Negative Device Clock Inputs. When FIR85 is disabled, the input frequency to these pins ( $f_{CLK}$ ) is the DAC clock frequency ( $f_{DAC}$ ). When FIR85 is enabled, $f_{DAC} = 2 \times f_{CLK}$ .
E7, E8	AMP_3P3_OUT	3.3 V Analog Supply Voltage for the Output Stage of the Amplifier.
E12, M7, M12	VDD_IO	Supply Voltage for CMOS Input/Output and SPI. Operational for 1.8 V to 3.3 V plus tolerance (see Table 1 for details).
E13, E14, F5, F6, F12 to F16 F7, F8, F9	DAC_1P2_CLK AMP_5V_IN	1.2 V Clock Supply Voltage. 5 V Analog Supply Voltage for the Input Stage of the Amplifier. Pin F7 to Pin F9 internally supply the full-scale current to the output stage of the DAC.
H1, J1	SYSREF+, SYSREF-	System Reference Positive and Negative Inputs. The H1 and J1 pins are self biased for ac coupling. They both can be either ac-coupled or dc-coupled.
H7, J8, K13, P8	DNC	Do Not Connect. Do not connect these pins. Leave the DNC pins floating.
H12	DAC_VBGNEG	DAC Band Gap Voltage. Connect Pin H12 with a 0.1 $\mu$ F capacitor to DAC_N1P2_AN.
J12	SDIO	Serial Port Data Input/Output. CMOS levels on Pin J12 are determined with respect to VDD_IO. See the Serial Data I/O (SDIO) section for details.
J13	SDO	Serial Port Data Output. CMOS levels on Pin J13 are determined with respect to VDD_IO.
J14	SCLK	Serial Port Data Clock. CMOS levels on Pin J14 are determined with respect to VDD_IO. See the Serial Clock (SCLK) section for details.
L1, M1 L4, L15, M4, M8, M10, M11, M15, N4, N15, P5, P6, P10, P13, P14, R5 to R7, R13 to R15	SERDIN7+, SERDIN7- DAC_1P2_SER	SERDES Lane 7 Negative and Positive Inputs. 1.2 V SERDES Digital Supply.
L5 L18, M18 M5	$\overline{IRQ}$ SERDIN0+, SERDIN0- TX_ENABLE	Interrupt Request Output (Active Low, Open Drain). SERDES Lane 1 Positive and Negative Inputs. Transmit Enable Input. Pin M5 can be used instead of the DAC output bias power-down bits in Register 0x040, Bits[1:0], to enable the DAC output. CMOS levels are determined with respect to VDD_IO.



Pin No.	Mnemonic	Description
M6	RESET	Reset (Active Low) Input. CMOS levels on Pin M6 are determined with respect to VDD_IO.
M13	$\overline{\text{CS\_DAC}}$	DAC Serial Port Chip Select (Active Low) Input. CMOS levels on Pin M13 are determined with respect to VDD_IO.
N6 to N14	DAC_1P2_DIG	1.2 V Digital Supply Voltage for the Digital Signal Processing (DSP) Blocks of the DAC.
P1, R1	SERDIN6+, SERDIN6-	SERDES Lane 6 Negative and Positive Inputs.
P7, P15	DAC_3P3_SYNC	3.3 V SERDES Sync Supply Voltage.
P12, R12	$\overline{\text{SYNCOUT-}}$ , SYNCOUT+	Negative and Positive LVDS Sync (Active Low) Output Signals.
P18, R18	SERDIN1+, SERDIN1-	SERDES Lane 1 Positive and Negative Inputs.
R10	SERPLL_LDO_BYPASS	SERDES PLL Supply Voltage Bypass. Connect this pin with a 1 $\Omega$ resistor in series with a 1 $\mu\text{F}$ capacitor to ground.
V15, V14	SERDIN2+, SERDIN2-	SERDES Lane 2 Positive and Negative Inputs.
V12, V11	SERDIN3+, SERDIN3-	SERDES Lane 3 Positive and Negative Inputs.
V7, V8	SERDIN4+, SERDIN4-	SERDES Lane 4 Negative and Positive Inputs.
V4, V5	SERDIN5+, SERDIN5-	SERDES Lane 5 Negative and Positive Inputs.

# TYPICAL PERFORMANCE CHARACTERISTICS

## AC PERFORMANCE (2x NRZ (FIR85) MODE)

$I_{OUTFS} = 20\text{ mA}$ ,  $f_{CLK} = 6.0\text{ GHz}$ , FIR85 enabled ( $f_{DAC} = 2 \times f_{CLK}$ ), interpolation = 4, nominal supplies,  $T_A = 25^\circ\text{C}$ , unless otherwise noted. When data is transmitted across a JESD204B link: if  $f_{CLK} \leq 5.0\text{ GHz}$ , then interpolation = 2x; if  $f_{CLK} > 5.0\text{ GHz}$ , then interpolation = 4x.

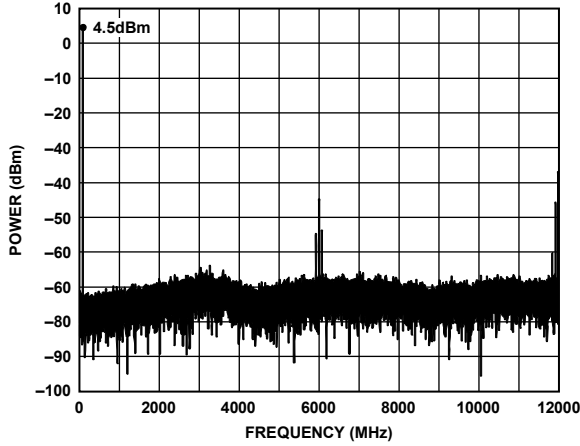

Figure 4. Single-Tone Spectrum at  $f_{OUT} = 71\text{ MHz}$

20810-004

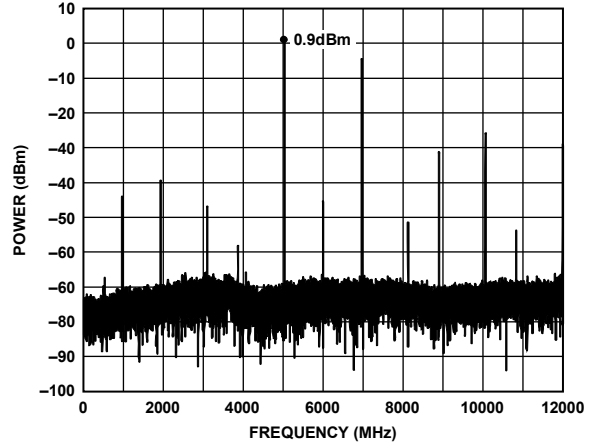

Figure 7. Single-Tone Spectrum at  $f_{OUT} = 5032\text{ MHz}$

20810-007

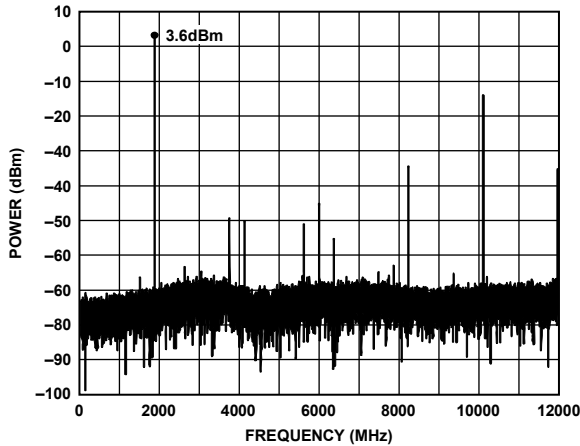

Figure 5. Single-Tone Spectrum at  $f_{OUT} = 1875\text{ MHz}$

20810-005

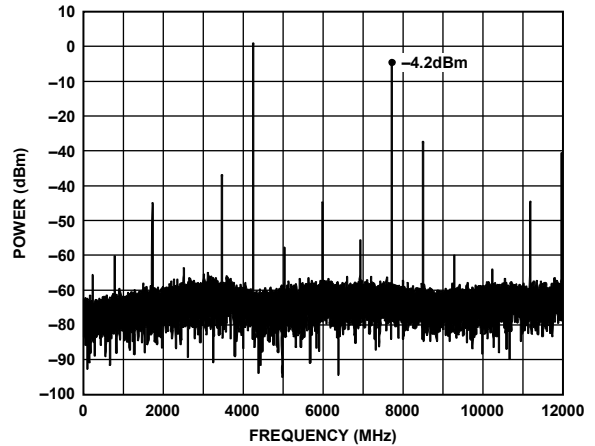

Figure 8. Single-Tone Spectrum at  $f_{OUT} = 7738\text{ MHz}$

20810-008

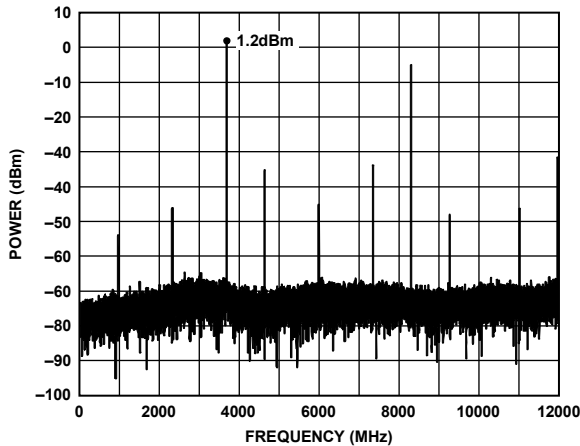

Figure 6. Single-Tone Spectrum at  $f_{OUT} = 3679\text{ MHz}$

20810-006

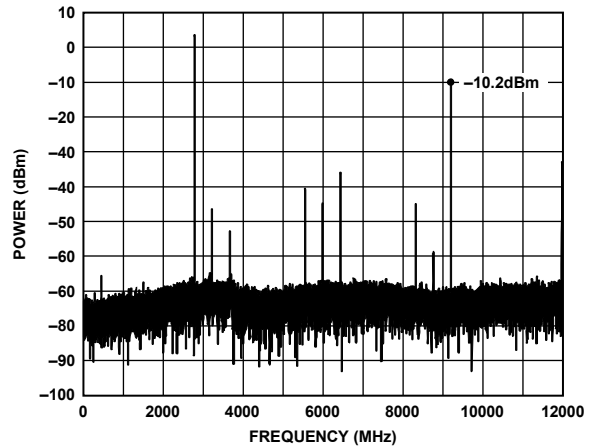

Figure 9. Single-Tone Spectrum at  $f_{OUT} = 9222\text{ MHz}$

20810-009

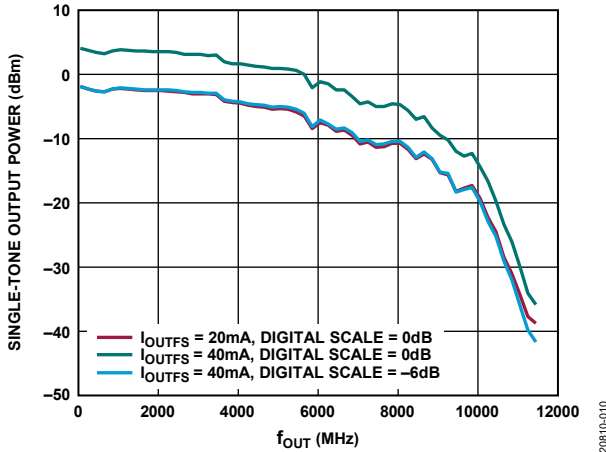

Figure 10. Single-Tone Output Power vs.  $f_{OUT}$ , over Digital Scale and  $I_{OUTFS}$

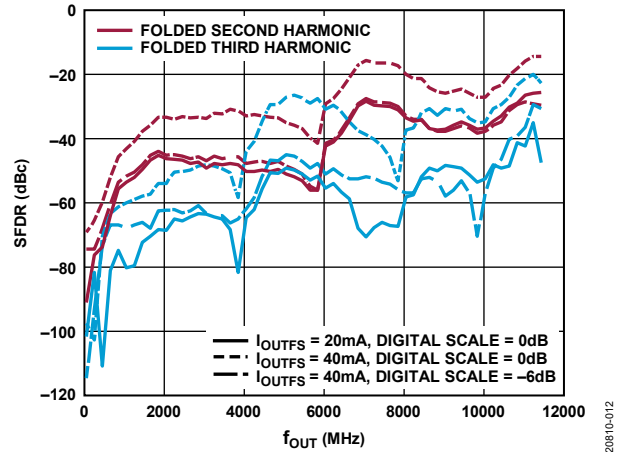

Figure 13. SFDR vs.  $f_{OUT}$  over Digital Scale and  $I_{OUTFS}$ , Folded Second and Third Harmonics

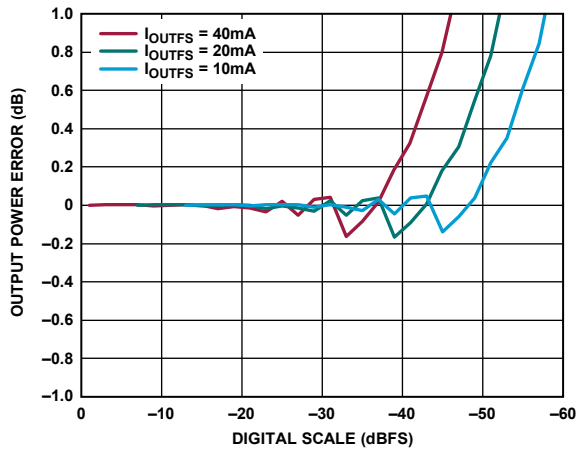

Figure 11. Output Power Error vs. Digital Scale, over  $I_{OUTFS}$ ,  $f_{OUT} = 503$  MHz

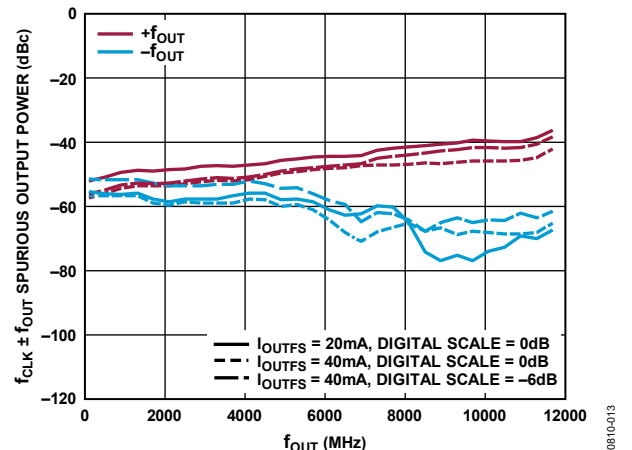

Figure 14.  $f_{CLK} \pm f_{OUT}$  Spurious Output Power vs.  $f_{OUT}$ , over Digital Scale and  $I_{OUTFS}$

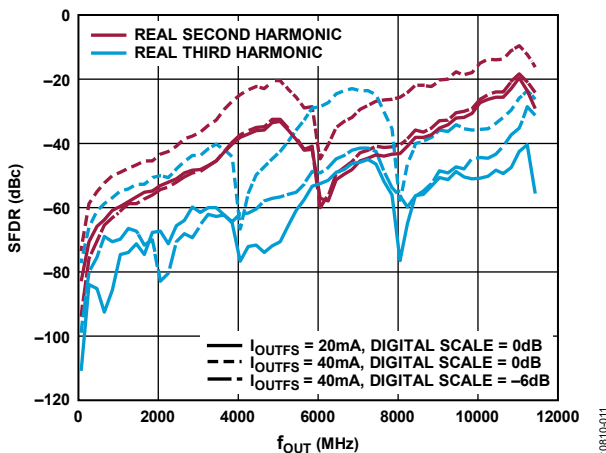

Figure 12. SFDR vs.  $f_{OUT}$  over Digital Scale and  $I_{OUTFS}$ , Real Second and Third Harmonics

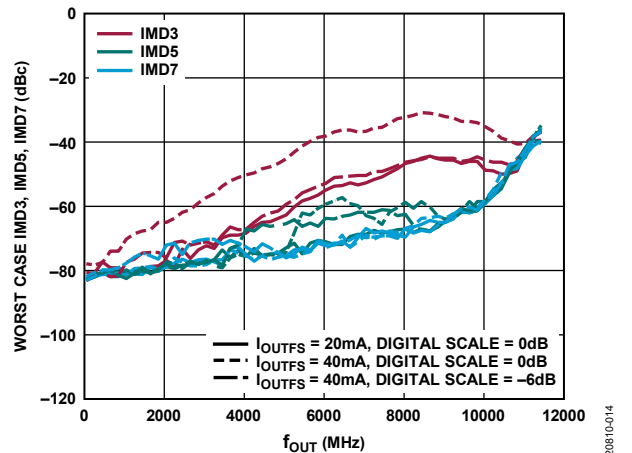

Figure 15. Worst Case Third-Order, Fifth-Order, and Seventh-Order Intermodulation (IMD3, IMD5, IMD7) vs.  $f_{OUT}$ , over Digital Scale and  $I_{OUTFS}$

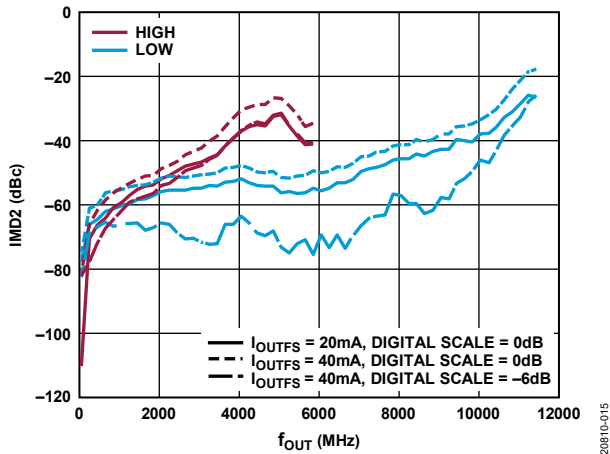

Figure 16. Second-Order Intermodulation (IMD2) vs.  $f_{OUT}$  over Digital Scale and  $I_{OUTFS}$

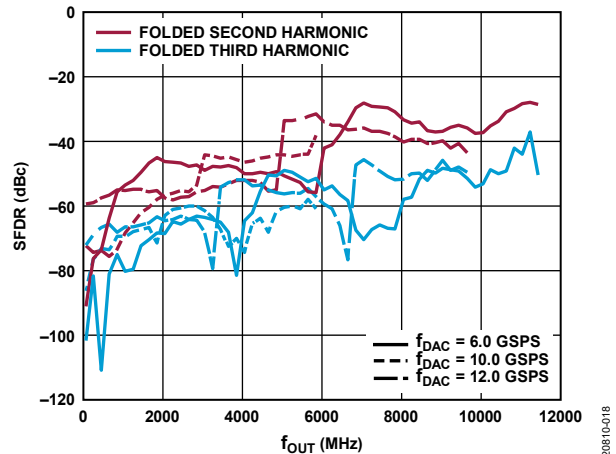

Figure 19. SFDR vs.  $f_{OUT}$  over  $f_{DAC}$ , Folded Second and Third Harmonics

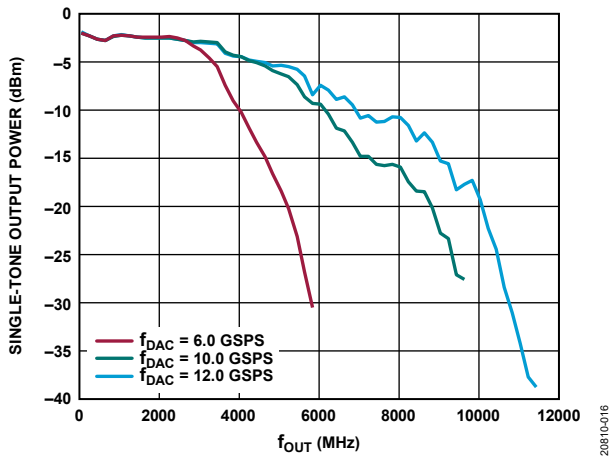

Figure 17. Single-Tone Output Power vs.  $f_{OUT}$  over  $f_{DAC}$

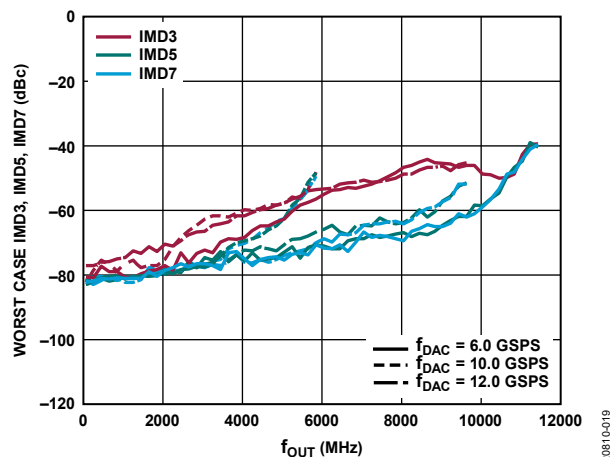

Figure 20. Worst Case IMD3, IMD5, IMD7 vs.  $f_{OUT}$  over  $f_{DAC}$

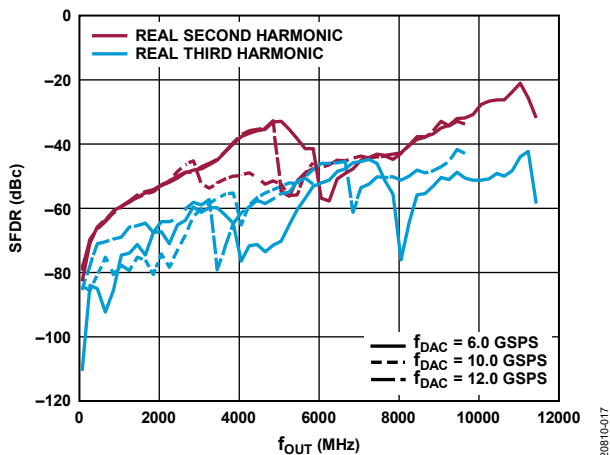

Figure 18. SFDR vs.  $f_{OUT}$  over  $f_{DAC}$ , Real Second and Third Harmonics

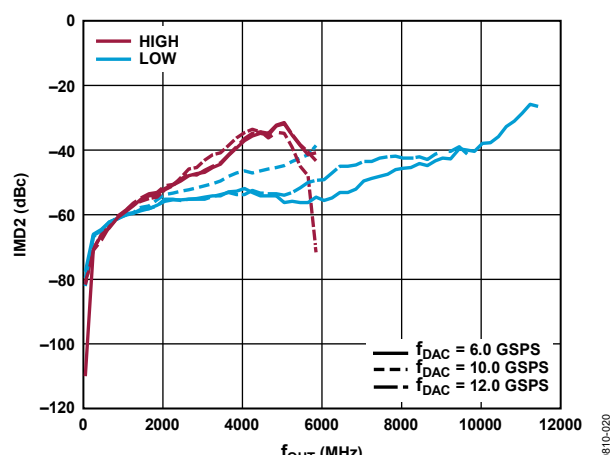

Figure 21. IMD2 vs.  $f_{OUT}$  over  $f_{DAC}$

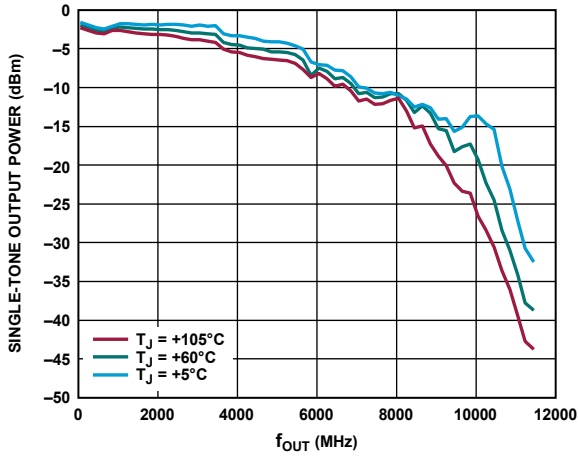

Figure 22. Single-Tone Output Power vs.  $f_{OUT}$ , over Temperature

20810-021

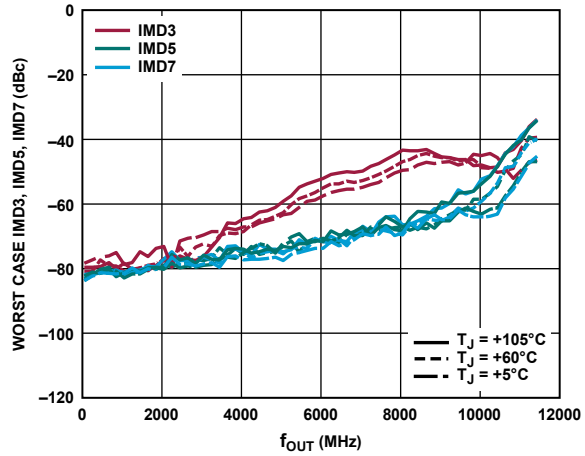

Figure 25. Worst Case IMD3, IMD5, IMD7 vs.  $f_{OUT}$  over Temperature

20810-024

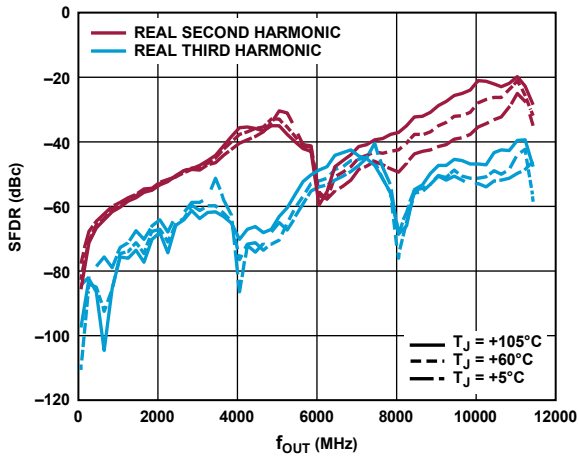

Figure 23. SFDR vs.  $f_{OUT}$  over Temperature, Real Second and Third Harmonics

20810-022

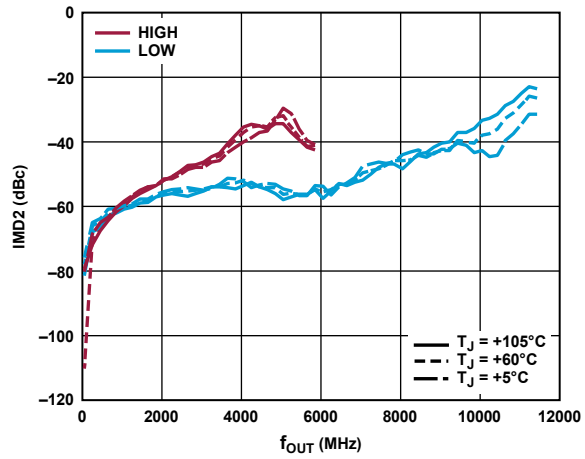

Figure 26. IMD2 vs.  $f_{OUT}$  over Temperature

20810-025

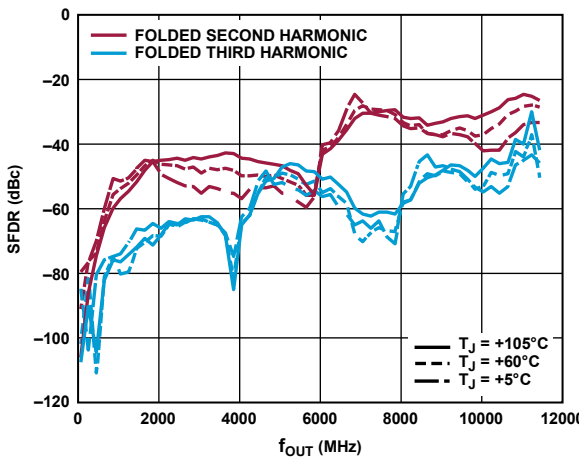

Figure 24. SFDR vs.  $f_{OUT}$  over Temperature, Folded Second and Third Harmonics

20810-023

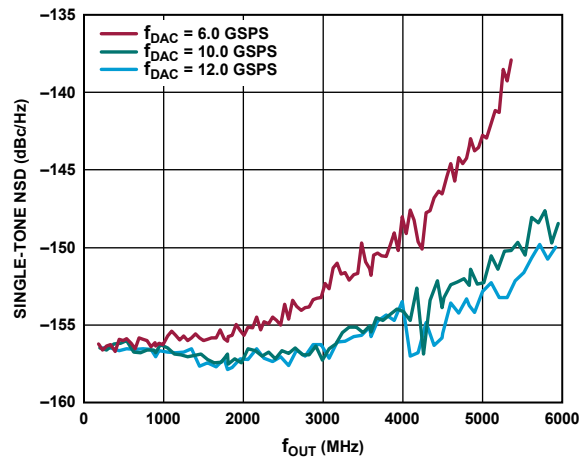

Figure 27. Single-Tone NSD vs.  $f_{OUT}$  over  $f_{CLK}$ ,  $I_{OUTFS} = 40$  mA, NSD Measured at 10% Offset from  $f_{OUT}$

20810-026

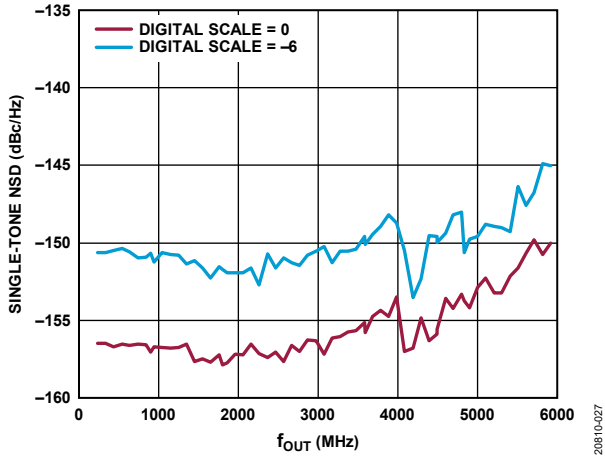

Figure 28. Single-Tone NSD vs.  $f_{OUT}$  over Digital Scale,  $I_{OUTFS} = 40$  mA, NSD Measured at 10% Offset from  $f_{OUT}$

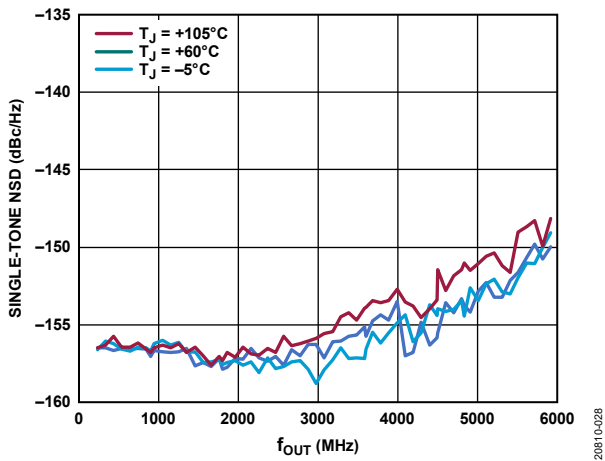

Figure 29. Single-Tone NSD vs.  $f_{OUT}$  over Temperature,  $I_{OUTFS} = 40$  mA, NSD Measured at 10% Offset from  $f_{OUT}$

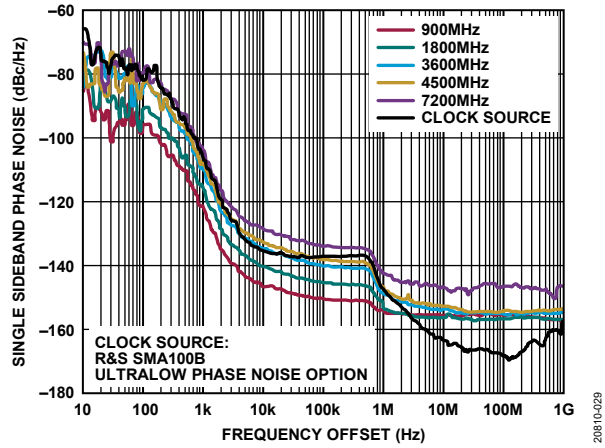

Figure 30. Single Sideband Phase Noise vs. Frequency Offset over  $f_{OUT}$ ,  $f_{DAC} = 12,042.24$  MSPS

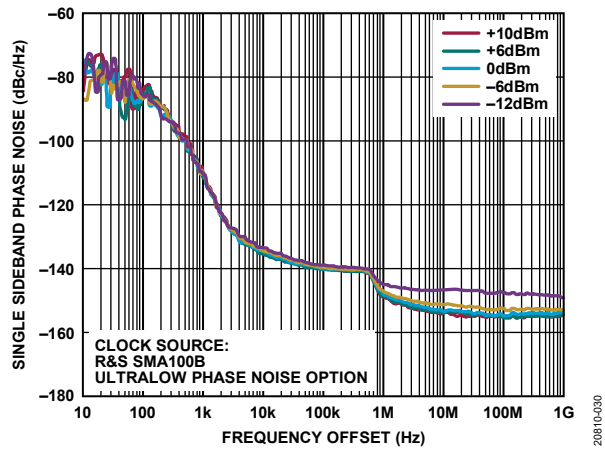

Figure 31. Single Sideband Phase Noise vs. Frequency Offset over Clock Power,  $f_{DAC} = 12,042.24$  MSPS,  $f_{OUT} = 3.6$  GHz

**LTE PERFORMANCE (2x NRZ (FIR85) MODE)**

$I_{OUTFS} = 20 \text{ mA}$ ,  $f_{CLK} = 6021.12 \text{ MHz}$ , FIR85 enabled ( $f_{DAC} = 2 \times f_{CLK}$ ), nominal supplies,  $T_A = 25^\circ\text{C}$ , unless otherwise noted. When data is transmitted across a JESD204B link: if  $f_{CLK} \leq 5.0 \text{ GHz}$ , then interpolation = 2x; if  $f_{CLK} > 5.0 \text{ GHz}$ , then interpolation = 4x.

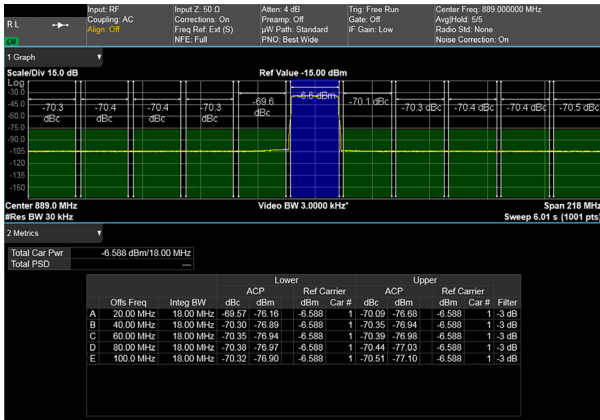

Figure 32. 20 MHz LTE Carrier ACLR at 889.0 MHz

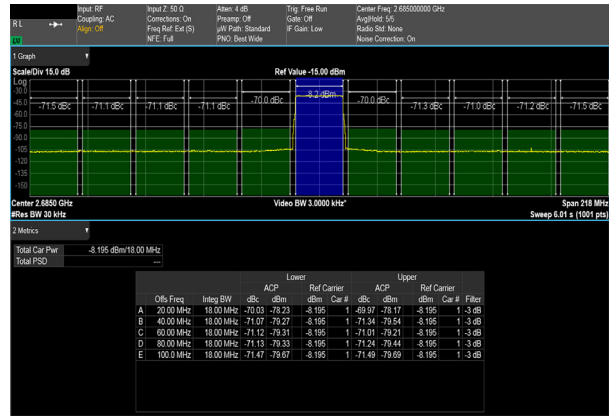

Figure 35. 20 MHz LTE Carrier ACLR at 2685.0 MHz

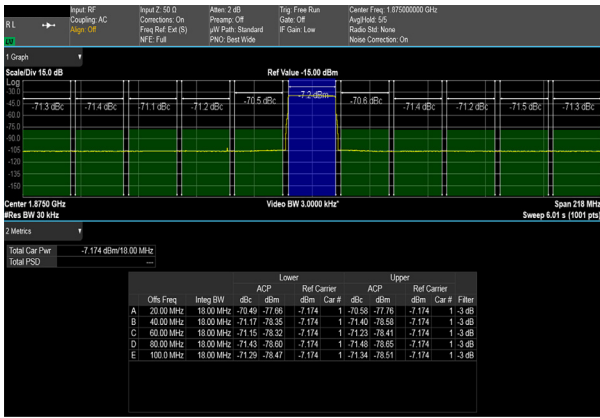

Figure 33. 20 MHz LTE Carrier ACLR at 1875.0 MHz

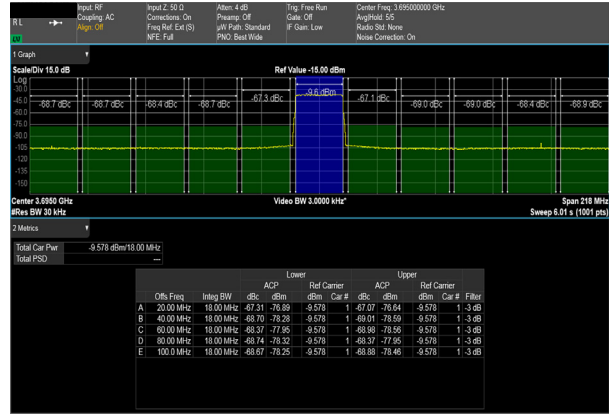

Figure 36. 20 MHz LTE Carrier ACLR at 3695.0 MHz

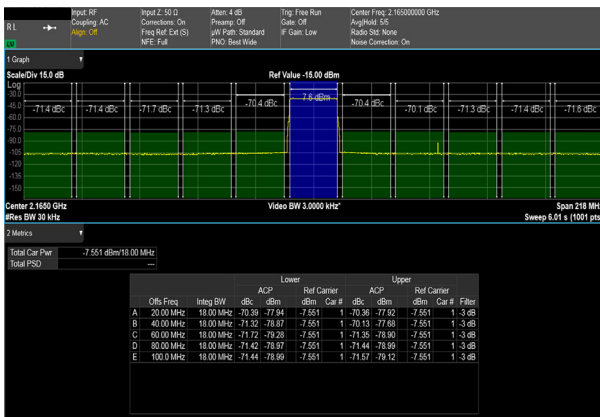

Figure 34. 20 MHz LTE Carrier ACLR at 2165.0 MHz

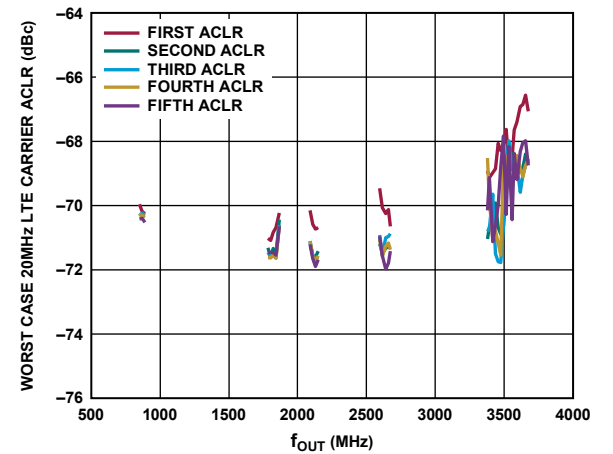

Figure 37. Worst Case 20 MHz LTE Carrier ACLR vs.  $f_{OUT}$

**802.11AC PERFORMANCE (2x NRZ (FIR85) MODE)**

$I_{OUTFS} = 20 \text{ mA}$ ,  $f_{CLK} = 6021.12 \text{ MHz}$ , FIR85 enabled ( $f_{DAC} = 2 \times f_{CLK}$ ), nominal supplies,  $T_A = 25^\circ\text{C}$ , unless otherwise noted. When data is transmitted across a JESD204B link: if  $f_{CLK} \leq 5.0 \text{ GHz}$ , then interpolation = 2x; if  $f_{CLK} > 5.0 \text{ GHz}$ , then interpolation = 4x.

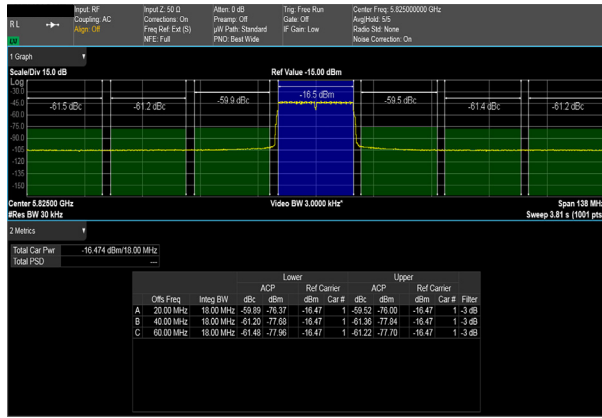

Figure 38. 20 MHz 802.11AC ACLR at 5825.0 MHz

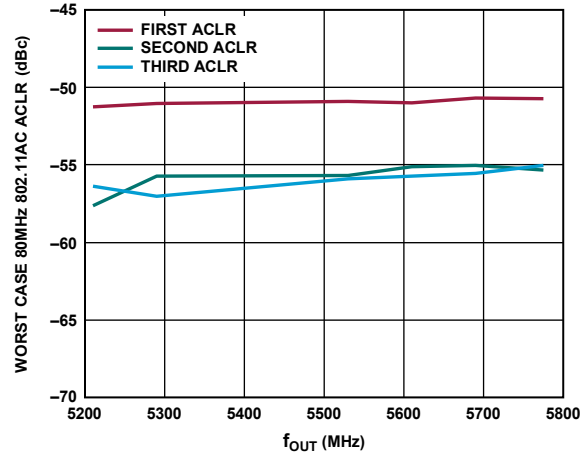

Figure 41. Worst Case 80 MHz 802.11AC ACLR vs.  $f_{OUT}$

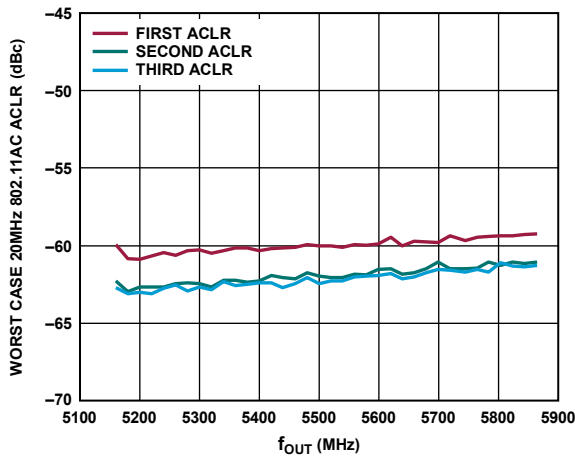

Figure 39. Worst Case 20 MHz 802.11AC ACLR vs.  $f_{OUT}$

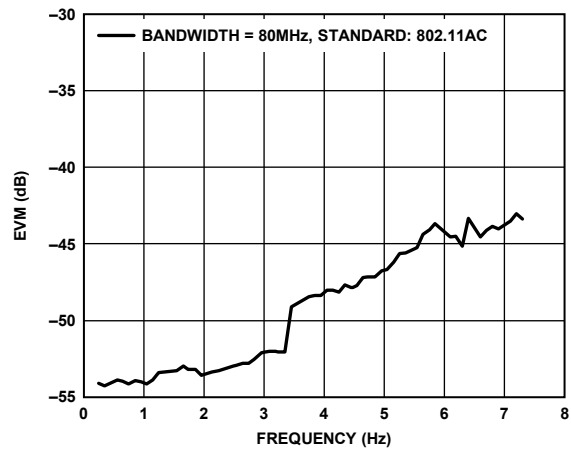

Figure 42. EVM vs. Frequency, 80 MHz Channel, Swept Across First, Second, and Third Nyquist,  $f_{DAC} = 11796.48 \text{ MSPS}$



Figure 40. 80 MHz 802.11AC ACLR at 5530.0 MHz



## TERMINOLOGY

### Offset Error

Offset error is the deviation of the DAC output current from the ideal of 0 mA.

### Gain Error

Gain error is the difference between the actual and ideal output span. The actual span is determined by the difference between the output when the input is at its minimum code and the output when the input is at its maximum code.

### Temperature Drift

Temperature drift is specified as the maximum change from the ambient (25°C) value to the value at either  $T_{MIN}$  or  $T_{MAX}$ . For offset and gain drift, the drift is reported in ppm of full-scale range (FSR) per degree Celsius. For reference drift, the drift is reported in ppm per degree Celsius.

### Settling Time

Settling time is the time required for the output to reach and remain within a specified error band around its final value, measured from the start of the output transition.

### Spurious-Free Dynamic Range (SFDR)

SFDR is the difference, in decibels relative to carrier (dBc), between the peak amplitude of the output signal and the peak spurious signal within the dc to Nyquist frequency of the DAC. Typically, energy in this band is rejected by the interpolation filters. This specification, therefore, defines how well the interpolation filters work and the effect of other parasitic coupling paths on the DAC output.

### x-Order Intermodulation Distortion (IMD<sub>x</sub>)

IMD<sub>x</sub> (where x is 2, 3, 5, or 7 for second-order, third-order, fifth-order, or seventh-order intermodulation distortion) is the difference, in decibels relative to carrier (dBc), between the peak amplitude of the output signal and the peak intermodulation product of a specific x-order within the dc to Nyquist frequency of the DAC. The signal is composed of two continuous wave tones. If multiple IMD<sub>x</sub> products are present, the IMD<sub>x</sub> that is located nearest to the signal and containing the highest power is chosen to calculate the difference. This specification defines the linearity of the analog output stage.

### Signal-to-Noise Ratio (SNR)

SNR is the ratio of the rms value of the measured output signal to the rms sum of all other spectral components below the Nyquist frequency, excluding the first six harmonics and dc. The value for SNR is expressed in decibels.

### Error Vector Magnitude (EVM)

EVM defines the average deviation of a modulation symbol from its ideal location within a decision boundary. Typically, EVM is quoted as the rms average of all error vector magnitudes between the received symbols and their ideal locations, for a given modulation order. For example, EVM for a quadrature phase shift keying (QPSK) signal is the average of the EVM across four decision boundaries. EVM is measured using a baseband signal that is a pseudorandom binary sequence (PRBS) of a statistically significant length.

### Interpolation Filter

If the digital inputs to the DAC are sampled at a multiple rate of the interpolation rate ( $f_{DATA}$ ), a digital filter can be constructed that has a sharp transition band near  $f_{DATA}/2$ . Images that typically appear around the output data rate ( $f_{DAC}$ ) can be greatly suppressed.

### Adjacent Channel Leakage Ratio (ACLR)

ACLR is the ratio in decibels relative to the carrier (dBc) between the measured power within a channel relative to its adjacent channel.

### Adjusted DAC Update Rate

The adjusted DAC update rate is the DAC update rate divided by the smallest interpolating factor. For clarity on DACs with multiple interpolating factors, the adjusted DAC update rate for each interpolating factor can be given.

### Physical Lane

Physical Lane x refers to SERDIN<sub>x±</sub>, where x represents 0 to 7.

### Logical Lane

Logical Lane x (where x represents 0 to 7) refers to physical lanes after optionally being remapped by the crossbar block (Register 0x308 to Register 0x30B).

### Link Lane

Link Lane x refers to logical lanes considered in the link, where x represents 0 to 7.

## THEORY OF OPERATION

The AD9166 is a high performance, wideband, transmit subsystem, composed of a high speed JESD204B SERDES interface, a flexible 16-bit digital datapath, a I/Q DAC core, along with an integrated differential to single-ended buffer amplifier that is matched to a 50  $\Omega$  load at dc to 10 GHz.

The AD9166 DAC core uses the patented quad-switch architecture, which enable DAC decoder settings that can extend the output frequency range into the second and third Nyquist zones with mix mode, RZ mode, and 2 $\times$  NRZ mode (with FIR85 enabled). The output can cover a range from 0 Hz to more than 9 GHz in 2 $\times$  NRZ mode. Mix mode can be used to access 1.5 GHz to around 9 GHz at a reduced device power consumption when compared to 2 $\times$  NRZ. The NCO can then shift a signal of up to 1.8 GHz instantaneous bandwidth to the desired  $f_{OUT}$ .

Figure 1 shows a functional block diagram of the AD9166. Eight high speed serial lanes carry data at a maximum speed of 12.5 Gbps, and either a 5 GSPS real input or a 2.5 GSPS complex input data rate to the digital datapath. Compared to either LVDS or CMOS interfaces, the SERDES interface simplifies pin count, board layout, and input clock requirements to the device.

The clock for the input data is derived from the device clock (required by the JESD204B specification). This device clock is sourced with a high fidelity, direct, external device sampling clock. The performance of the DAC core can be optimized by using on-chip adjustments to the device clock input accessible through the SPI port. The SERDES interface can be configured to operate in one-lane, two-lane, three-lane, four-lane, six-lane, or eight-lane mode, depending on the required input data rate.

The digital datapath of the AD9166 offers a bypass (1 $\times$ ) mode and several interpolation modes (2 $\times$ , 3 $\times$ , 4 $\times$ , 6 $\times$ , 8 $\times$ , 12 $\times$ , 16 $\times$ , and 24 $\times$ ) through either an initial half-band (2 $\times$ ) or third-band (3 $\times$ ) filter with programmable 80% or 90% bandwidth, and three subsequent half-band filters (all 90%) with a maximum DAC core sample rate of 6.0 GSPS. An inverse sinc filter is provided to compensate for sinc related roll-off. An additional half-band filter, FIR85, takes advantage of the quad-switch architecture to interpolate on the falling edge of the clock, and effectively double the DAC update rate in 2 $\times$  NRZ mode. A 48-bit programmable modulus numerically controlled oscillator (NCO) is provided to enable digital frequency shifts of signals with near infinite precision. The NCO can be operated alone in NCO only mode or with digital data from the SERDES interface and

digital datapath. The 100 MHz speed of the SPI write interface enables rapid updating of the frequency tuning word (FTW) of the NCO.

In addition to the main 48-bit NCO, the AD9166 also offers an FFH NCO for selected DDS applications. The FFH NCO consists of 32, 32-bit NCOs, each with its own phase accumulator, a FTW select register to select one of the NCOs, and a phase coherent hopping mode. Together, these elements enable phase coherent FFH. With the FTW select register and the 100 MHz SPI, dwell times as fast as 260 ns can be achieved.

The differential core output is buffered and converted to a single-ended output. The buffer is designed using a proprietary BiCMOS process, which greatly improves the spectral response of the core at higher operating frequencies. The improved spectral response is essential for applications where extra wide signal bandwidth and spectral flatness and purity are required. Its output has impedance match to 50  $\Omega$ , up to 10 GHz, which eases impedance matching concerns in wideband applications. The differential to single-ended buffer eliminates the need for an expensive, wideband balun, and supports the full operating range of the DAC core, from true dc to 9 GHz. DC coupling also allows baseband waveform generation, eliminating the need for external bias tees or similar circuitry.

The AD9166 is capable of multichip synchronization that can both synchronize multiple subsystems and establish a constant and deterministic latency (latency locking) path to the subsystem output. The latency for each of the subsystems remains constant to within several device clock cycles from link establishment to link establishment. An external alignment (SYSREF+ or SYSREF-) signal makes the AD9166 Subclass 1 compliant. Several modes of SYSREF $\pm$  signal handling are available for use in the system.

An SPI configures the various functional blocks and monitors their statuses. The various functional blocks and the data interface must be set up in a specific sequence for proper operation (see the Start-Up Sequence section). Simple SPI initialization routines set up the JESD204B link and are included in the evaluation board package. This data sheet describes the various blocks of the AD9166 in greater detail. Descriptions of the JESD204B interface, control parameters, and various registers to set up and monitor the device are provided. The recommended start-up routine reliably sets up the data link.

## SERIAL PORT OPERATION

The AD9166 includes two separate SPI controllers, one for the DAC and one for the amplifier. Either the DAC or the amplifier can be addressed using the same SDIO, SDO, and SCLK pins, while asserting the corresponding chip select pin, CS\_AMP or CS\_DAC. CS\_AMP and CS\_DAC cannot be asserted simultaneously to address both the DAC and the amplifier during the same communication cycle, as described in the Chip Select (CS\_AMP and CS\_DAC) section.

The serial port is a flexible, synchronous serial communications port that allows easy interfacing with many industry-standard microcontrollers and microprocessors. The serial input/output (I/O) is compatible with most synchronous transfer formats, including both the Motorola SPI and Intel® SSR protocols. The interface allows read/write access to all registers that configure the AD9166. MSB first or LSB first transfer formats are supported. The serial port interface can be configured as a 4-wire interface or a 3-wire interface in which the input and output share a single-pin I/O (SDIO).

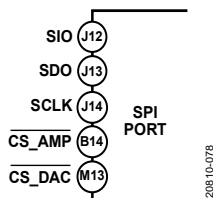

Figure 43. Serial Port Interface Pins

There are two phases to a communication cycle with the AD9166. Phase 1 is the instruction cycle (the writing of an instruction byte into the device), coincident with the first 16 SCLK rising edges. The instruction word provides the serial port controller with information regarding the data transfer cycle, Phase 2 of the communication cycle. The Phase 1 instruction word defines whether the upcoming data transfer is a read or write, along with the starting register address for the following data transfer.

A logic high on the pin followed by a logic low resets the serial port timing to the initial state of the instruction cycle. From this state, the next 16 rising SCLK edges represent the instruction bits of the current I/O operation.

The remaining SCLK edges are for Phase 2 of the communication cycle. Phase 2 is the actual data transfer between the device and the system controller. Phase 2 of the communication cycle is a transfer of one or more data bytes. Eight  $\times$  N SCLK cycles are needed to transfer N bytes during the transfer cycle. Registers change immediately upon writing to the last bit of each transfer byte, except for the FTW and NCO phase offsets, which change only when the frequency tuning word FTW\_LOAD\_REQ bit is set.

A logic high on CS\_AMP or CS\_DAC followed by a logic low resets the serial port timing to the initial state of the instruction cycle. From this state, the next 16 rising SCLK edges represent the instruction bits of the current I/O operation.

The remaining SCLK edges are for Phase 2 of the communication cycle. Phase 2 is the actual data transfer between the device and the system controller. Phase 2 of the communication cycle is a transfer of one or more data bytes. Eight  $\times$  N SCLK cycles are needed to transfer N bytes during the transfer cycle. Registers change immediately upon writing to the last bit of each transfer byte, except for the FTW and NCO phase offsets, which change only when the frequency tuning word bit, FTW\_LOAD\_REQ, is set.

### DATA FORMAT

The instruction byte contains the information listed in Table 14.

Table 14. Serial Port Instruction Word

I15 (MSB)	I[14:0]
R/W	A[14:0]

R/W, Bit I15 of the instruction word, determines whether a read or a write data transfer occurs after the instruction word write. Logic 1 indicates a read operation, and Logic 0 indicates a write operation.

A14 to A0, Bit I14 to Bit I0 of the instruction word, determine the register that is accessed during the data transfer portion of the communication cycle. For multibyte transfers, A[14:0] is the starting address. The remaining register addresses are generated by the device based on the address increment bit. If the address increment bits are set high (Register 0x000, Bit 5 and Bit 2), multibyte SPI writes start on A[14:0] and increment by 1 for every eight bits sent or received. If the address increment bits are set to 0, the address decrements by 1 every eight bits.

### SERIAL PORT PIN DESCRIPTIONS

#### Serial Clock (SCLK)

The serial clock pin synchronizes data to and from the device and runs the internal state machines. The maximum frequency of SCLK is 100 MHz. All data input is registered on the rising edge of SCLK. All data is driven out on the falling edge of SCLK.

#### Chip Select (CS\_AMP and CS\_DAC)

The AD9166 includes two chip select pins, one for the DAC (CS\_DAC) and one for the buffer amplifier (CS\_AMP), hereafter referred to as CS\_x. The correct CS\_x pin must be asserted to address the particular silicon die. CS\_AMP and CS\_DAC cannot be asserted simultaneously.

An active low input starts and gates a communication cycle. CS\_x allows more than one device to be used on the same serial communications line. The SDIO pin goes to a high impedance state when this input is high. During the communication cycle, the chip select must stay low.

#### Serial Data I/O (SDIO)

The SDIO pin is a bidirectional data line. In 4-wire mode, the SDIO pin acts as the data input and the SDO pin acts as the data output.

**SERIAL PORT OPTIONS**

The serial port can support both MSB first and LSB first data formats. This functionality is controlled by the LSB first bit (Register 0x000, Bit 6 and Bit 1). The default is MSB first (LSB bit = 0).

When the LSB first bits = 0 (MSB first), the instruction and data bits must be written from MSB to LSB. Read/write (R/W) is followed by the instruction word, A[14:0], and D[7:0], the data-word. When the LSB first bits = 1 (LSB first), the opposite is true. A[0:14] is followed by R/W, which is subsequently followed by D[0:7].

The serial port supports a 3-wire or 4-wire interface. When the SDO active bits = 1 (Register 0x000, Bit 4 and Bit 3), a 4-wire interface with a separate input pin (SDIO) and output pin (SDO) is used. When the SDO active bits = 0, the SDO pin is unused and the SDIO pin is used for both the input and the output.

**Multibyte Data Transfers**

Multibyte data transfers can be performed by holding CS\_AMP or CS\_DAC low for multiple data transfer cycles (eight SCLK cycles) after the first data transfer word following the instruction cycle. The first eight SCLK cycles following the instruction cycle read from or write to the register provided in the instruction cycle. For each additional eight SCLK cycles, the address is either incremented or decremented and the read/write occurs on the new register. The direction of the address is set using ADDRINC or ADDRINC\_M (Register 0x000, Bit 5 and Bit 2).

When ADDRINC or ADDRINC\_M is 1, the multicycle addresses are incremented. When ADDRINC or ADDRINC\_M is 0, the addresses are decremented. A new write cycle can always be initiated by bringing CS\_x high and then low again.

To prevent confusion and to ensure consistency between devices, the chip tests the first nibble following the address phase, ignoring the second nibble. This test is completed independently from the LSB first bits and ensures that there are extra clock cycles following the soft reset bits (Register 0x000, Bit 0 and Bit 7). This test of the first nibble only applies when writing to Register 0x000.

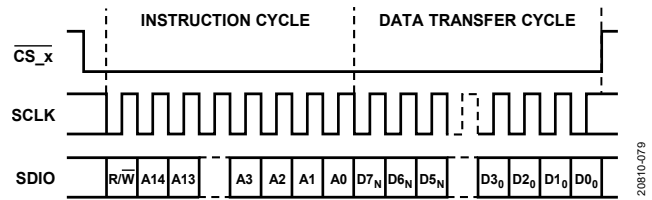

Figure 44. Serial Register Interface Timing, MSB First, Register 0x000, Bit 5 and Bit 2 = 0

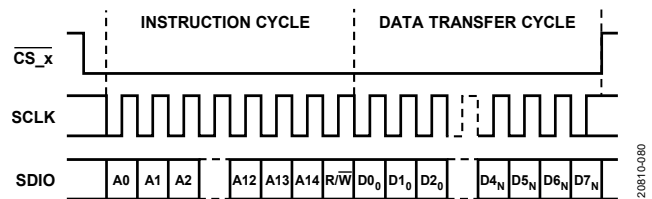

Figure 45. Serial Register Interface Timing, LSB First, Register 0x000, Bit 5 and Bit 2 = 1

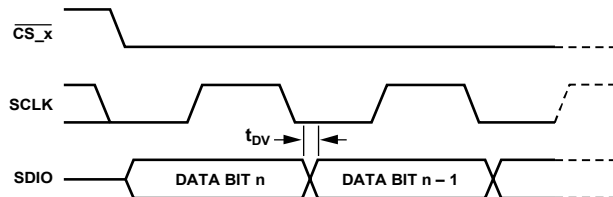

Figure 46. Timing Diagram for Serial Port Register Read

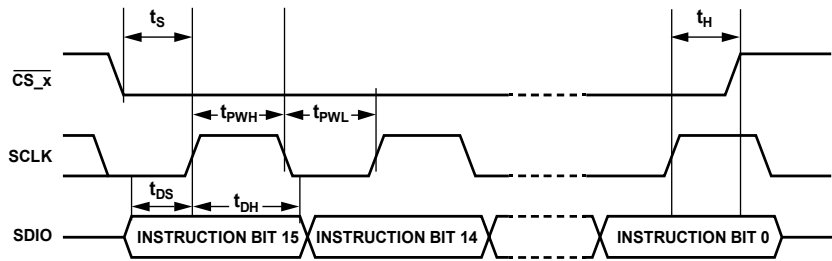

Figure 47. Timing Diagram for Serial Port Register Write

# JESD204B SERIAL DATA INTERFACE

## JESD204B OVERVIEW

The AD9166 has eight JESD204B data ports that receive data. The eight JESD204B ports can be configured as part of a single JESD204B link that uses a single system reference (SYSREF±) and device clock (CLK±).

The JESD204B serial interface hardware consists of three layers: the physical layer, the data link layer, and the transport layer. These sections of the hardware are described in subsequent sections, including information for configuring every aspect of the interface. Figure 48 shows the communication layers implemented in the AD9166 serial data interface to recover the clock and deserialize, descramble, and deframe the data before it is sent to the digital signal processing section of the device.

The physical layer establishes a reliable channel between the transmitter and the receiver, the data link layer is responsible for unpacking the data into octets and descrambling the data. The transport layer receives the descrambled JESD204B frames and converts them to DAC samples.

Various JESD204B parameters (L, F, K, M, N, NP, S, HD) define how the data is packed and tell the device how to turn the serial data into samples. These parameters are defined in the Transport Layer section. The AD9166 also has a descrambling option (see the Descrambler section for more information).

The various combinations of JESD204B parameters that are supported depend solely on the number of lanes. Thus, a unique set of parameters can be determined by selecting the

lane count to be used. In addition, the interpolation rate and number of lanes can be used to define the rest of the configuration needed to set up the AD9166. The interpolation rate and the number of lanes are selected in Register 0x110.

The AD9166 has a single DAC output. However, for the purposes of the complex signal processing on chip, whenever interpolation is used, the converter count is defined as  $M = 2$ .

For a particular application, the number of converters to use (M) and the data rate variable (DataRate) are known. The lane rate variable (LaneRate) and number of lanes (L) can be traded off as follows:

$$DataRate = (DACRate)/(InterpolationFactor)$$

$$LaneRate = (20 \times DataRate \times M)/L$$

where LaneRate must be between 750 Mbps and 12.5 Gbps.

Achieving and recovering synchronization of the lanes is very important. To simplify the interface to the transmitter, the AD9166 designates a master synchronization signal for each JESD204B link. The SYNCOUT- and SYNCOUT+ pins are used as the master signal for all lanes. If any lane in a link loses synchronization, a resynchronization request is sent to the transmitter via the synchronization signal of the link. The transmitter stops sending data and instead sends synchronization characters to all lanes in that link until resynchronization is achieved.

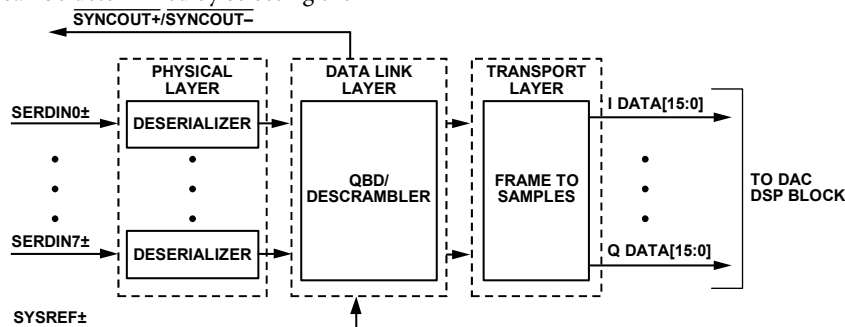

Figure 48. Functional Block Diagram of Serial Link Receiver

Table 15. Single-Link JESD204B Operating Modes

Parameter	Parametric Symbol	Number of Lanes (L)					
		1	2	3	4	6	8
Lane Count	L	1	2	3	4	6	8
Converter Count	M	2	2	2	2	2	1 (real), 2 (complex)
Octets per Frame per Lane	F	4	2	4	1	2	1
Samples per Converter per Frame	S	1	1	3	1	3	4 (real), 2 (complex)

Table 16. Data Structure per Lane for JESD204B Operating Modes<sup>1</sup>

JESD204B Operating Mode	Lane No.	Frame 0	Frame 1	Frame 2	Frame 3
L = 8, M = 1, F = 1, S = 4	Lane 0	MOS0[15:8]			
	Lane 1	MOS0[7:0]			
	Lane 2	MOS1[15:8]			
	Lane 3	MOS1[7:0]			
	Lane 4	MOS2[15:8]			
	Lane 5	MOS2[7:0]			
	Lane 6	MOS3[15:8]			
	Lane 7	MOS3[7:0]			
L = 8, M = 2, F = 1, S = 2	Lane 0	MOS0[15:8]			
	Lane 1	MOS0[7:0]			
	Lane 2	MOS1[15:8]			
	Lane 3	MOS1[7:0]			
	Lane 4	M1S0[15:8]			
	Lane 5	M1S0[7:0]			
	Lane 6	M1S1[15:8]			
	Lane 7	M1S1[7:0]			
L = 6, M = 2, F = 2, S = 3	Lane 0	MOS0[15:8]	MOS0[7:0]		
	Lane 1	MOS1[15:8]	MOS1[7:0]		
	Lane 2	MOS2[15:8]	MOS2[7:0]		
	Lane 3	M1S0[15:8]	M1S0[7:0]		
	Lane 4	M1S1[15:8]	M1S1[7:0]		
	Lane 5	M1S2[15:8]	M1S2[7:0]		
L = 4, M = 2, F = 1, S = 1	Lane 0	MOS0[15:8]			
	Lane 1	MOS0[7:0]			
	Lane 2	M1S0[15:8]			
	Lane 3	M1S0[7:0]			
L = 3, M = 2, F = 4, S = 3	Lane 0	MOS0[15:8]	MOS0[7:0]	MOS1[15:8]	MOS1[7:0]
	Lane 1	MOS2[15:8]	MOS2[7:0]	M1S0[15:8]	M1S0[7:0]
	Lane 2	M1S1[15:8]	M1S1[7:0]	M1S2[15:8]	M1S2[7:0]
L = 2, M = 2, F = 2, S = 1	Lane 0	MOS0[15:8]	MOS0[7:0]		
	Lane 1	M1S0[15:8]	M1S0[7:0]		
L = 1, M = 2, F = 4, S = 1	Lane 0	MOS0[15:8]	MOS0[7:0]	M1S0[15:8]	M1S0[7:0]

<sup>1</sup> Mx is the converter number and Sy is the sample number. For example, MOS0 means Converter 0, Sample 0. Blank cells are not applicable.

**PHYSICAL LAYER**

The physical layer of the JESD204B interface, hereafter referred to as the deserializer, has eight identical channels. Each channel consists of the terminators, an equalizer, a clock and data recovery (CDR) circuit, and the 1:40 demux function (see Figure 49).

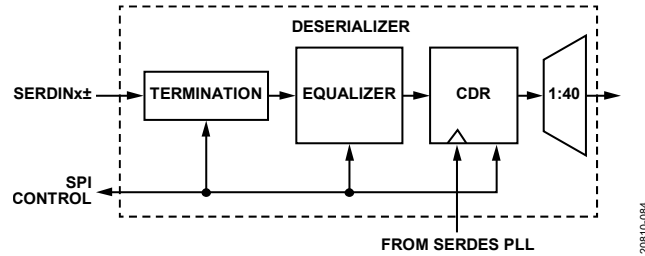

Figure 49. Deserializer Block Diagram

JESD204B data is input to the AD9166 via the SERDINx± 1.2 V differential input pins as per the JESD204B specification.

**Interface Power-Up and Input Termination**

Before using the JESD204B interface, it must be powered up by setting Register 0x200, Bit 0 = 0. In addition, each physical lane (PHY) that is not being used (SERDINx±) must be powered down. To do so, set the corresponding Bit x for Physical Lane x in Register 0x201 as follows:

- Set the bit to 0 when the physical lane is used.
- Set the bit to 1 when the physical lane is not used.

The AD9166 autocalibrates the input termination to 50 Ω. Before running the termination calibration, Register 0x2A7 and Register 0x2AE must be written as described in Table 17 to guarantee proper calibration. The termination calibration begins when Register 0x2A7, Bit 0 and Register 0x2AE, Bit 0 transition from low to high.

- Register 0x2A7 controls autocalibration for PHY 0, PHY 1, PHY 6, and PHY 7.
- Register 0x2AE controls autocalibration for PHY 2, PHY 3, PHY 4, and PHY 5.

The PHY x termination autocalibration routine is listed in Table 17.

**Table 17. PHYx Termination Autocalibration Routine**

Address	Value	Description
0x2A7	0x01	Autocalibrate PHY 0, PHY 1, PHY 6, and PHY 7 terminations
0x2AE	0x01	Autocalibrate PHY 2, PHY 3, PHY 4, and PHY 5 terminations

The input termination voltage of the DAC is sourced externally through the DAC\_1P2\_SER pins. It is recommended that the JESD204B inputs be ac-coupled to the JESD204B transmit device using 100 nF capacitors.

The calibration code of the termination can be read from Bits[3:0] in Register 0x2AC (PHY 0, PHY 1, PHY 6, and PHY 7) and Register 0x2B3 (PHY 2, PHY 3, PHY 4, and PHY 5). If needed, the termination values can be adjusted or set using several registers. To override the autocalibrated termination values,

use the TERM\_BLKx\_CTRLREG1 registers (Register 0x2A8 and Register 0x2AF). Set the registers as follows:

- Default setting: set to 0xFFFFXXXX. The termination block autocalibrates the termination values.
- Overwrite setting: set to 0xFFFF1XXXX to overwrite the autocalibration with the termination values in Bits[3:1] of Register 0x2A8 and Register 0x2AF.

Individual offsets from the autocalibration value for each lane are programmed in Bits[3:0] of Register 0x2BB to Register 0x2C2. The value is a signed magnitude, with Bit 3 as the sign bit. The total range of the termination resistor value is about 94 Ω to 120 Ω, with approximately 3.5% increments across the range (for example, smaller steps at the bottom of the range than at the top).

**Receiver Eye Mask**

The AD9166 complies with the JESD204B specification regarding the receiver eye mask and is capable of capturing data that complies with this mask. Figure 50 shows the receiver eye mask normalized to the data rate interval with a 600 mV V<sub>TT</sub> swing. See the JESD204B specification for more information regarding the eye mask and permitted receiver eye opening.

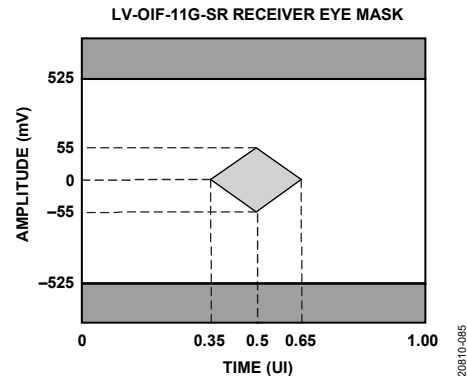

Figure 50. Receiver Eye Mask for 600 mV V<sub>TT</sub> Swing

**Clock Relationships**

The following clock rates are used throughout the remainder of the JESD204B Serial Data Interface section. The relationship between any of the clocks can be derived from the following equations:

$$DataRate = (DACRate)/(InterpolationFactor)$$

$$LaneRate = (20 \times DataRate \times M)/L$$

$$ByteRate = LaneRate/10$$

where:

M is the JESD204B parameter for converters per link.

L is the JESD204B parameter for lanes per link.

This relationship comes from 8-bit/10-bit encoding, where each byte is represented by 10 bits.

$$PCLK\ Rate = ByteRate/4$$

The processing clock is used for a quad-byte decoder.

$$FrameRate = ByteRate/F$$

where F is JESD204B parameter for octets per frame per lane.

$$PCLK\ Factor = FrameRate/PCLK\ Rate = 4/F$$

## SERDES PLL

### Functional Overview of the SERDES PLL

The independent SERDES phase-locked loop (PLL) uses Integer N techniques to achieve clock synthesis. The entire SERDES PLL is integrated on chip, including the voltage controlled oscillator (VCO) and the loop filter. The SERDES PLL VCO operates over the range of 6 GHz to 12.5 GHz.

In the SERDES PLL, a VCO divider block divides the VCO clock by 2 to generate a 3 GHz to 6.25 GHz quadrature clock for the deserializer cores. This clock is the input to the CDR block that is described in the Clock and Data Recovery section.

The reference clock to the SERDES PLL is always running at a frequency,  $f_{REF}$ , that is equal to 1/40 of the lane rate (PCLK rate). The  $f_{REF}$  frequency is divided by an integer factor, set by SERDES\_PLL\_DIV\_FACTOR, to deliver a clock to the phase frequency detector (PFD) block,  $f_{PFD}$ , that is between 35 MHz and 80 MHz. Table 18 includes the respective SERDES\_PLL\_DIV\_FACTOR register settings for each of the desired PLL\_REF\_CLK\_RATE options available.

**Table 18. SERDES PLL Divider Settings**

Lane Rate (Gbps)	PLL_REF_CLK_RATE (Register 0x084, Bits[5:4])	SERDES_PLL_DIV_FACTOR (Register 0x289, Bits[1:0])
0.750 to 1.5625	0b01 = 2×	0b10 = ÷1
1.5 to 3.125	0b00 = 1×	0b10 = ÷1
3 to 6.25	0b00 = 1×	0b01 = ÷2
6 to 12.5	0b00 = 1×	0b00 = ÷4

### SERDES PLL Enable and Recalibration

Register 0x280 controls the synthesizer enable and recalibration.

To enable the SERDES PLL, first set the PLL divider register (see Table 18). Then enable the SERDES PLL by writing Register 0x280, Bit 0 = 1. If a recalibration is needed, write Register 0x280, Bit 2 = 0b1 and then reset the bit to 0b0. The rising edge of the bit causes a recalibration to begin.

Confirm that the SERDES PLL is working by reading Register 0x281. If Register 0x281, Bit 0 = 1, the SERDES PLL has locked. If Register 0x281, Bit 3 = 1, the SERDES PLL calibration has completed. If Register 0x281, Bit 4 or Bit 5 is high, the PLL reaches the lower or upper end of its calibration band and must be recalibrated by writing 0 and then 1 to Register 0x280, Bit 2.

### Clock and Data Recovery (CDR)

The deserializer is equipped with a CDR circuit. Instead of recovering the clock directly from the JESD204B serial lanes, the CDR circuit continuously aligns the phase of the sampling clocks for each SERDES lane with the incoming bit stream from the JESD204B transmitter. The sampling clocks are derived from the SERDES PLL. The 3 GHz to 6.25 GHz sampling clocks are derived from the SERDES PLL, as shown in Figure 54, at the input to the CDR.

To generate the lane rate clock inside the device, a CDR sampling mode must be selected as follows:

- For a lane rate greater than 6.25 Gbps, use half rate CDR.
- For a lane rate between 3 Gbps and 6.25 Gbps, disable half rate operation.
- For a lane rate less than 3 Gbps, disable full rate and enable 2× oversampling to recover the appropriate lane rate clock.

Table 19 lists the CDR sampling settings that must be set depending on the lane rate value.

**Table 19. CDR Operating Modes**

Lane Rate (Gbps)	SPI_ENHALFRATE (Register 0x230, Bit 5)	SPI_DIVISION_RATE (Register 0x230, Bits[2:1])
0.750 to 1.5625	0 (full rate)	0b10 (divide by 4)
1.5 to 3.125	0 (full rate)	0b01 (divide by 2)
3 to 6.25	0 (full rate)	0b00 (no divide)
6 to 12.5	1 (half rate)	0b00 (no divide)

The CDR circuit synchronizes the phase used to sample the data on each serial lane independently. This independent phase adjustment per serial interface ensures accurate data sampling and eases the implementation of multiple serial interfaces on a PCB.

After configuring the CDR circuit, reset it and then release the reset by writing 0 and then writing 1 to Register 0x206, Bit 0.

In some clocking configuration, it may be necessary to reset the CDR after the JESD204B transmitter begins sending /K/ characters as part of the JESD204B serial link establishment, so that the CDR restarts its search loop and aligns the clocks correctly (see the JESD204B Serial Link Establishment section).

### Power-Down Unused PHYs

Unused lanes that are left enabled consume extra power unnecessarily. Each lane that is not in use (SERDINx±) must be powered off by writing a 1 to the corresponding bit of PHY\_PD (Register 0x201).

### Equalization

To compensate for signal integrity distortions for each PHY channel due to PCB trace length and impedance, the AD9166 employs an easy to use, low power equalizer on each JESD204B channel. The AD9166 equalizers can compensate for insertion losses far greater than required by the JESD204B specification. The equalizers have two modes of operation that are determined by the EQ\_POWER\_MODE register setting in Register 0x268, Bits[7:6]. In low power mode (Register 0x268, Bits[7:6] = 0b01) and operating at the maximum lane rate of 12.5 Gbps, the equalizer can compensate for up to 11.5 dB of insertion loss. In normal mode (Register 0x268, Bits[7:6] = 0b00), the equalizer can compensate for up to 17.2 dB of insertion loss. This performance is shown in Figure 51 as an overlay to the JESD204B specification for insertion loss. Figure 51 shows the equalization performance at 12.5 Gbps, near the maximum baud rate for the AD9166.



Figure 52 and Figure 53 are provided as points of reference for hardware designers and show the insertion loss for various lengths of well laid out stripline and microstrip transmission lines, respectively. See the Hardware Considerations section for specific layout recommendations for the JESD204B channel.

Low power mode is recommended if the insertion loss of the JESD204B PCB channels is less than that of the most lossy supported channel for low power mode (shown in Figure 51). If the insertion loss is greater than that, but still less than that of the most lossy supported channel for normal mode (shown in Figure 51), use normal mode. At 12.5 Gbps operation, the equalizer in normal mode consumes about 4 mW more power per lane than in low power equalizer mode. Note that either mode can be used in conjunction with transmitter preemphasis to ensure functionality and/or optimize for power.

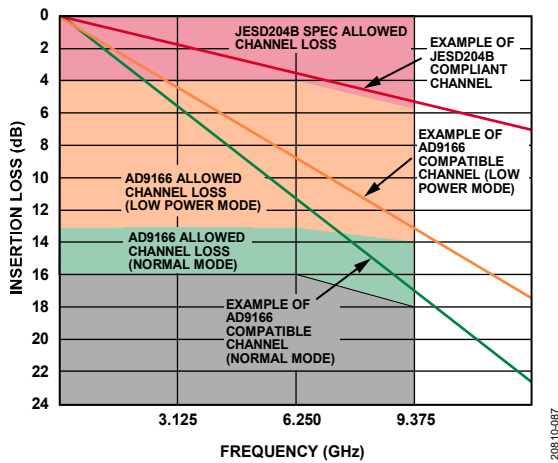

Figure 51. Insertion Loss Allowed

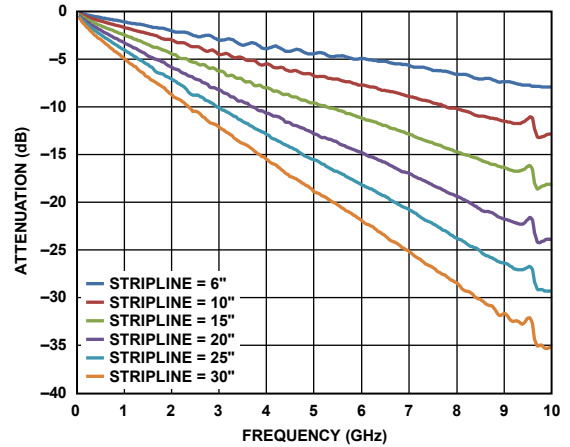

Figure 52. Insertion Loss of 50  $\Omega$  Striplines on FR4

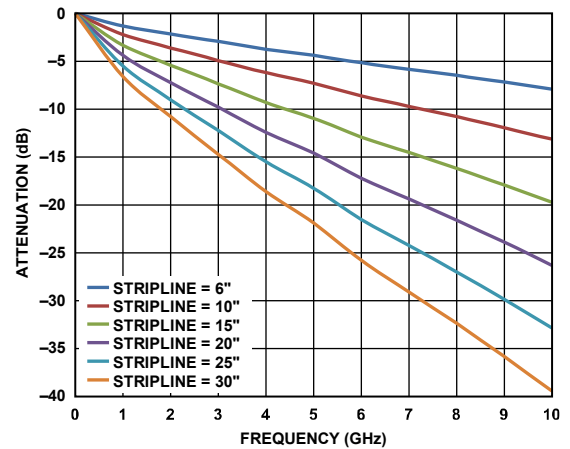

Figure 53. Insertion Loss of 50  $\Omega$  Microstrips on FR4

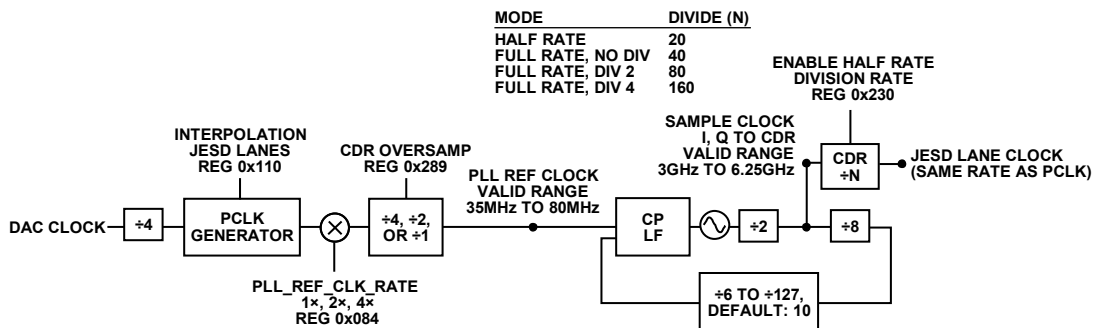

Figure 54. SERDES PLL Synthesizer Block Diagram Including VCO Divider Block

**DATA LINK LAYER**

The data link layer of the AD9166 JESD204B interface accepts the deserialized data from the PHYs and deframes, and descrambles them so that data octets are presented to the transport layer to be put into DAC samples. The architecture of the data link layer is shown in Figure 55. The data link layer consists of a synchronization FIFO for each lane, a crossbar switch, a deframer, and a descrambler.

The AD9166 can operate as a single-link high speed JESD204B serial data interface. All eight lanes of the JESD204B interface handle link layer communications such as code group synchronization (CGS), frame alignment, and frame synchronization.

The AD9166 decodes 8-bit/10-bit control characters, allowing marking of the start and end of the frame and alignment

between serial lanes. Each AD9166 serial interface link can issue a synchronization request by setting its SYNCOUT± signal low. The synchronization protocol follows Section 4.9 of the JESD204B standard. When a stream of four consecutive /K/ symbols is received, the AD9166 deactivates the synchronization request by setting the SYNCOUT± signal high at the next internal local multiframe clock (LMFC) rising edge. Then, AD9166 waits for the transmitter to issue an initial lane alignment sequence (ILAS). During the ILAS, all lanes are aligned using the /A/ to /R/ character transition as described in the JESD204B Serial Link Establishment section. Elastic buffers hold early arriving lane data until the alignment character of the latest lane arrives. At this point, the buffers for all lanes are released and all lanes are aligned (see Figure 56).

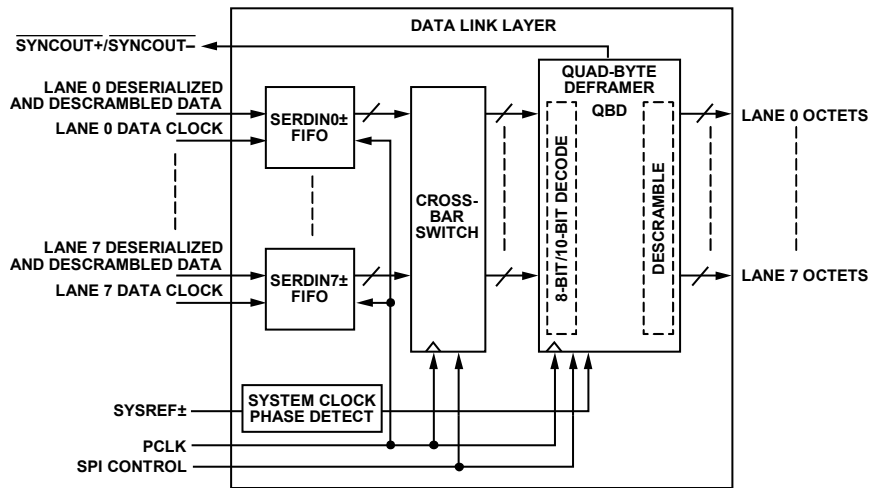

Figure 55. Data Link Layer Block Diagram

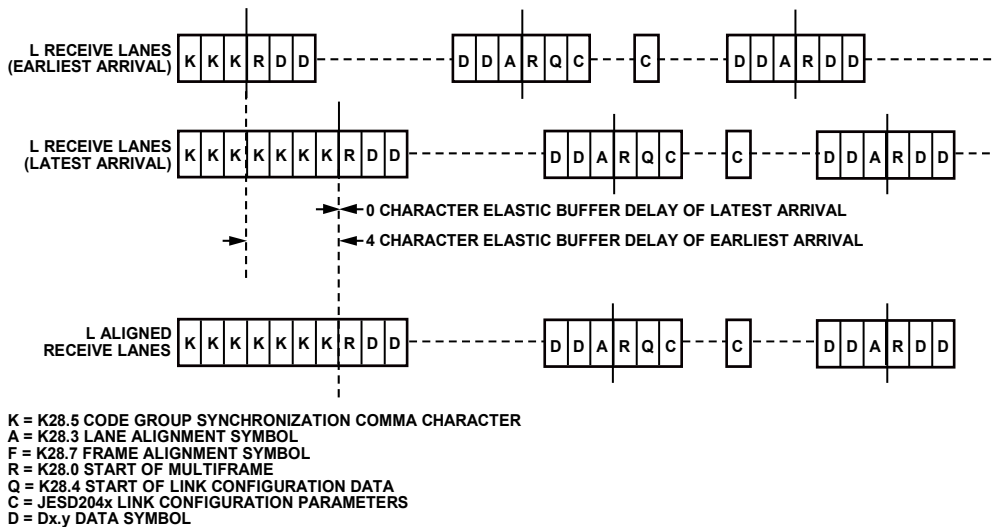

Figure 56. Lane Alignment During ILAS

### JESD204B Serial Link Establishment

A brief summary of the high speed serial link establishment process for Subclass 1 is provided. See Section 5.3.3 of the JESD204B specifications document for complete details.

#### Step 1: Code Group Synchronization

Each receiver must locate /K/ (K28.5) characters in its input bit stream. After four consecutive /K/ characters are detected on all link lanes, the receiver block deasserts the  $\overline{\text{SYNCOUT}}_{\pm}$  signal to the transmitter block at the receiver LMFC edge.

The transmitter captures the change in the  $\overline{\text{SYNCOUT}}_{\pm}$  signal and, at a future transmitter LMFC rising edge, starts the ILAS.

#### Step 2: Initial Lane Alignment Sequence

The main purposes of this phase are to align all the lanes of the link and to verify the parameters of the link.

Before the link is established, write each of the link parameters to the receiver device to designate how data is sent to the receiver block.

The ILAS consists of four or more multiframe. The last character of each multiframe is a multiframe alignment character, /A/. The first, third, and fourth multiframe are populated with predetermined data values. Note that Section 8.2 of the JESD204B specifications document describes the data ramp that is expected during ILAS. The AD9166 does not require this ramp. The deframer uses the final /A/ of each lane to align the ends of the multiframe within the receiver. The second multiframe contains an /R/ (K.28.0), /Q/ (K.28.4), and then data corresponding to the link parameters. Additional multiframe can be added to the ILAS if needed by the receiver. By default, the AD9166 uses four multiframe in the ILAS (this can be changed in Register 0x478). If using Subclass 1, exactly four multiframe must be used.

After the last /A/ character of the last ILAS, multiframe data begins streaming. The receiver adjusts the position of the /A/ character such that it aligns with the internal LMFC of the receiver at this point.

#### Step 3: Data Streaming

In this phase, data is streamed from the transmitter block to the receiver block. Optionally, data can be scrambled. Scrambling does not start until the very first octet following the ILAS.

The receiver block processes and monitors the data it receives for errors, including the following:

- Bad running disparity (8-bit/10-bit error)
- Not in table (8-bit/10-bit error)
- Unexpected control character
- Bad ILAS
- Interlane skew error (through character replacement)

If any of these errors exist, they are reported back to the transmitter in one of the following ways (see the JESD204B Error Monitoring section for details):

- $\overline{\text{SYNCOUT}}_{\pm}$  signal assertion: resynchronization ( $\overline{\text{SYNCOUT}}_{\pm}$  signal pulled low) is requested at each error for the last two errors. For the first three errors, an optional resynchronization request can be asserted when the error counter reaches a set error threshold.
- For the first three errors, each multiframe with an error in it causes a small pulse on  $\overline{\text{SYNCOUT}}_{\pm}$ .
- Errors can optionally trigger an interrupt request (IRQ) event, which can be sent to the transmitter.

For more information about the various test modes for verifying the link integrity, see the JESD204B Test Modes section.

#### Lane First In/First Out (FIFO)

The FIFOs in front of the crossbar switch and deframer synchronize the samples sent on the high speed serial data interface with the deframer clock by adjusting the phase of the incoming data. The FIFO absorbs timing variations between the data source and the deframer to allow up to two PCLK cycles of drift from the transmitter. The FIFO\_STATUS\_REG\_0 register and FIFO\_STATUS\_REG\_1 register (Register 0x30C and Register 0x30D, respectively) can be monitored to identify whether the FIFOs are full or empty.

#### Lane FIFO Interrupt Request (IRQ)

An aggregate lane FIFO overflow/underflow error bit is also available as an IRQ event. Use Register 0x020, Bit 2 to enable the FIFO overflow/underflow error bit, and then use Register 0x024, Bit 2 to read back its status and reset the IRQ signal. See the Interrupt Request Operation section for more information.

#### Crossbar Switch

Register 0x308 to Register 0x30B allow arbitrary mapping of physical lanes (SERDIN $x_{\pm}$ ) to logical lanes used by the SERDES deframers.

**Table 20. Crossbar Registers**

Address	Bits	Logical Lane
0x308	[2:0]	SRC_LANE0
0x308	[5:3]	SRC_LANE1
0x309	[2:0]	SRC_LANE2
0x309	[5:3]	SRC_LANE3
0x30A	[2:0]	SRC_LANE4
0x30A	[5:3]	SRC_LANE5
0x30B	[2:0]	SRC_LANE6
0x30B	[5:3]	SRC_LANE7

Write each SRC\_LANE $x$  with the number (x) of the desired physical lane (SERDIN $x_{\pm}$ ) from which to obtain data. By default, all logical lanes use the corresponding physical lane as their data source. For example, by default, SRC\_LANE0 = 0.

Therefore, Logical Lane 0 obtains data from Physical Lane 0 (SERDIN0±). To use SERDIN4± as the source for Logical Lane 0 instead, the user must write SRC\_LANE0 = 4 (decimal).

### Lane Inversion

Register 0x334 allows inversion of desired logical lanes, which can be used to ease routing of the SERDINx± signals. For each Logical Lane x, set Bit x of Register 0x334 to 1 to invert it.

### Deframer

The AD9166 consists of one quad-byte deframer (QBD). The QBD accepts the 8-bit/10-bit encoded data from the deserializer (via the crossbar switch), decodes it, and descrambles it into JESD204B frames before passing it to the transport layer to be converted to DAC samples. The deframer processes four symbols (or octets) per processing clock (PCLK) cycle.

The deframer uses the JESD204B parameters that the user has programmed into the register map to identify how the data is packed, and unpacks it. The JESD204B parameters are described in detail in the Transport Layer section. Many of the parameters are also needed in the transport layer to convert JESD204B frames into samples.

### Descrambler

The AD9166 provides an optional descrambler block using a self synchronous descrambler with the following polynomial:

$$1 + x^{14} + x^{15}$$

Enabling data scrambling reduces spectral peaks that are produced when the same data octets repeat from frame to frame. Data scrambling also makes the spectrum data independent so that possible frequency selective effects on the electrical interface do not cause data dependent errors. Descrambling of the data is enabled by setting the SCR bit (Register 0x453, Bit 7) to 1.

### Synchronizing LMFC Signals

The first step to ensuring synchronization across links and devices begins with synchronizing the LMFC signals. In Subclass 0, the LMFC signal is synchronized to an internal processing clock. In Subclass 1, LMFC signals are synchronized to an external SYSREF± signal.

### SYSREF± Signal

The SYSREF± signal is a differential source synchronous input that synchronizes the LMFC signals in both the transmitter and receiver in a JESD204B Subclass 1 system to achieve deterministic latency.

The SYSREF± signal is sampled by a divide by 4 version of the device clock ( $f_{CLK}$ ). For fixed phase alignment between signals, generate the device clock and SYSREF± signals from the same source, such as the [HMC7044](#) clock generator. When designing for optimum deterministic latency operation, consider the timing distribution skew of the SYSREF± signal in a multipoint link system (multichip).

Because SYSREF± is sampled with  $f_{CLK} \div 4$ , there is a four- $f_{CLK}$  cycle ambiguity between the SYSREF± edge and  $f_{CLK}$ . The phase of the  $f_{CLK} \div 4$  clock used to sample SYSREF± is stored in Register 0x037, Bits[7:0] and Register 0x038, Bits[3:0] as a thermometer code. This value determines which  $f_{CLK}$  cycle the SYSREF± edge corresponds to, which is used to compensate for the cycle ambiguity and improve deterministic latency uncertainty. The compensation must be performed outside the AD9166 by delaying or advancing the data samples,  $f_{CLK}$ , or the SYSREF± signal to be sampled. After compensation, the deterministic latency uncertainty can be improved to 0  $f_{CLK}$  cycles between device resets, as long as the sample and hold times for SYSREF± are met across the device operating conditions.

As an indication whether setup and hold times for SYSREF± were met, monitor the values in SYNC\_LMFC\_STATx (Register 0x034 and Register 0x035) after a SYSREF± edge is sampled, resetting the register before each reading by writing 0x0 to Register 0x34. The SYNC\_LMFC\_STATx value must be constant across multiple readings. Refer to the Sync Procedure section for more details.

The AD9166 supports a periodic SYSREF± signal. The periodicity can be continuous, strobed, or gapped periodic. The SYSREF± signal can always be dc-coupled (with a common-mode voltage of 0 V to 1.25 V). When dc-coupled, a small amount of common-mode current (<500  $\mu$ A) is drawn from the SYSREF± pins. See Figure 57 for the SYSREF± internal circuit.

To avoid this common-mode current draw, use a 50% duty cycle periodic SYSREF± signal with ac coupling capacitors. If ac-coupled, the ac coupling capacitors combine with the resistors shown in Figure 57 to make a high-pass filter with an RC time constant of  $\tau = RC$ . Select C such that  $\tau > 4/\text{SYSREF}\pm$  frequency. In addition, the edge rate must be sufficiently fast to meet the SYSREF± vs. device clock ( $f_{CLK}$ ) keep out window requirements.

It is possible to use ac-coupled mode without meeting the frequency to time constant constraints ( $\tau = RC$  and  $\tau > 4/\text{SYSREF}\pm$  frequency) by using SYSREF± hysteresis (Register 0x088 and Register 0x089). However, using hysteresis increases the  $f_{CLK}$  keep out window (the setup and hold specifications in Table 10 do not apply) by an amount depending on the SYSREF± frequency, level of hysteresis, capacitor choice, and edge rate.

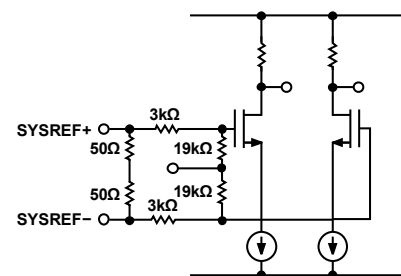

Figure 57. SYSREF± Input Circuit

### Sync Processing Modes Overview

The AD9166 supports several LMFC sync processing modes. These modes are one shot, continuous, and monitor modes. All sync processing modes perform a phase check to confirm that the LMFC is phase aligned to an alignment edge. In Subclass 1, the SYSREF± signal acts as the alignment edge. In Subclass 0, an internal processing clock (PCLK) acts as the alignment edge.

The sync modes are described in the following sections (One-Shot Sync Mode (SYNC\_MODE = Register 0x03A, Bits[1:0] = 0b10), Continuous Sync Mode (SYNC\_MODE = Register 0x03A, Bits[1:0] = 0b01), Monitor Sync Mode (SYNC\_MODE = Register 0x03A, Bits[1:0] = 0b00), and Sync Procedure). See the Sync Procedure section for details on the procedure for syncing the LMFC signals.

#### One-Shot Sync Mode (SYNC\_MODE = Register 0x03A, Bits[1:0] = 0b10)

In one-shot sync mode, a phase check occurs on only the first alignment edge that is received after the sync machine is armed. After the phase is aligned on the first edge, the AD9166 transitions to monitor mode. Though an LMFC synchronization occurs only once, the SYSREF± signal can still be continuous. In this case, the phase is monitored and reported, but no clock phase adjustment occurs.

#### Continuous Sync Mode (SYNC\_MODE = Register 0x03A, Bits[1:0] = 0b01)

Continuous sync mode must be used in Subclass 1 only with a periodic SYSREF± signal. In continuous sync mode, a phase check/alignment occurs on every alignment edge.

Continuous sync mode differs from one-shot sync mode in two ways. First, no SPI cycle is required to arm the device. The alignment edge seen after continuous sync mode is enabled results in a phase check. Second, a phase check occurs on every alignment edge in continuous sync mode.

#### Monitor Sync Mode (SYNC\_MODE = Register 0x03A, Bits[1:0] = 0b00)

Monitor sync mode allows the user to monitor the phase error in real time. Use this sync mode with a periodic SYSREF± signal. The phase is monitored and reported, but no clock phase adjustment occurs.

When an alignment request (SYSREF± edge) occurs, snapshots of the last phase error are placed into readable registers for reference (Register 0x037 and Register 0x038, Bits[3:0]), and, if appropriate, the IRQ\_SYSREF\_JITTER interrupt is set.

#### Sync Procedure

The procedure for enabling the sync is as follows:

- Set up the DAC; the SERDES PLL locks it and enables the CDR (see the Start-Up Sequence section).
- Set Register 0x039 (SYSREF± jitter window). A minimum of four f<sub>CLK</sub> cycles is recommended. See Table 22 for settings.
- Optionally, read back the SYSREF± count to check whether the SYSREF± pulses are being received.
  - Set Register 0x036 = 0. Writing anything to SYSREF\_COUNT resets the count.
  - Set Register 0x034 = 0. Writing anything to SYNC\_LMFC\_STAT0 saves the data for readback and registers the count.
  - Read SYSREF\_COUNT from the value from Register 0x036.
- Perform a one-shot sync.
  - Set Register 0x03A = 0x00. Clear one shot mode if already enabled.
  - Set Register 0x03A = 0x02. Enable one-shot sync mode. The state machine enters monitor mode after a sync occurs.
- Optionally, read back the SYNC\_LMFC\_STATx registers to verify that the synchronization completed correctly.
  - Set Register 0x034 = 0. Register 0x034 must be written to read the value.
  - Read Register 0x035 and Register 0x034 to find the value of SYNC\_LMFC\_STATx. It is recommended to set SYNC\_LMFC\_STATx to 0 but it can be set to 4, or a LMFC period in f<sub>CLK</sub> - 4, due to jitter.
- Optionally, read back the SYSREF\_PHASEx registers to identify which phase of the divide by 4 was used to sample SYSREF±. Read Register 0x038 and Register 0x037 as thermometer code. The MSBs of Register 0x037, Bits[7:4] normally show the thermometer code value.
- Turn the link on (Register 0x300, Bit 0 = 1).
- Read back Register 0x302 (dynamic link latency).
- Repeat reestablishment of the link several times (Step 1 to Step 7) and note the dynamic link latency values. Based on the noted values, program the LMFC delay (Register 0x304) and the LMFC variable (Register 0x306), and then restart the link.

Table 21. Sync Processing Modes

Sync Processing Mode	SYNC_MODE (Register 0x03A, Bits[1:0])
No synchronization	0b00
One shot	0b10
Continuous	0b01

Table 22. SYSREF± Jitter Window Tolerance

SYSREF± Jitter Window Tolerance (f <sub>CLK</sub> Cycles)	SYSREF_JITTER_WINDOW (Register 0x039, Bits[5:0]) <sup>1</sup>
±½	0x00
±4	0x04
±8	0x08
±12	0x0C
±16	0x10
±20	0x14
±24	0x18
±28	0x1C

<sup>1</sup> The two least significant digits are ignored because the SYSREF± signal is sampled with a divide by 4 version of f<sub>CLK</sub>. As a result, the jitter window is set by the f<sub>CLK</sub> ÷ 4 clock rather than f<sub>CLK</sub>. It is recommended that at least a four-device clock SYSREF± jitter window be chosen.

### Deterministic Latency

JESD204B systems contain various clock domains distributed throughout its system. Data traversing from one clock domain to a different clock domain can lead to ambiguous delays in the JESD204B link. These ambiguities lead to nonrepeatable latencies across the link from power cycle to power cycle with each new link establishment. Section 6 of the JESD204B specification addresses the issue of deterministic latency with mechanisms defined as Subclass 1 and Subclass 2.

The AD9166 supports JESD204B Subclass 0 and Subclass 1 operation, but not Subclass 2. Write the subclass to Register 0x458, Bits[7:5].

#### Subclass 0

The Subclass 0 mode gives deterministic latency to within  $32 f_{CLK}$  cycles. This mode does not require any signal on the  $SYSREF_{\pm}$  pins, which can be left disconnected.

Subclass 0 still requires that all lanes arrive within the same LMFC cycle.

#### Subclass 1

Subclass 1 mode gives deterministic latency and allows latency to stay repeatable within a specified number of device clock ( $f_{CLK}$ ) periods between synchronization events, as specified in Table 4. This mode requires an external  $SYSREF_{\pm}$  signal that is accurately phase aligned to  $f_{CLK}$ .

#### Deterministic Latency Requirements

Several key factors are required for achieving deterministic latency in a JESD204B Subclass 1 system.

- $SYSREF_{\pm}$  signal distribution skew within the system must be less than the desired uncertainty.
- $SYSREF_{\pm}$  setup and hold time requirements must be met for each device in the system.
- The total latency variation across all lanes, links, and devices must be  $\leq 10$  PCLK periods, which includes both variable delays and the variation in fixed delays from lane to lane, link to link, and device to device in the system.

#### Link Delay

The link delay of a JESD204B system is the sum of the fixed and variable delays from the transmitter, channel, and receiver as shown in Figure 58.

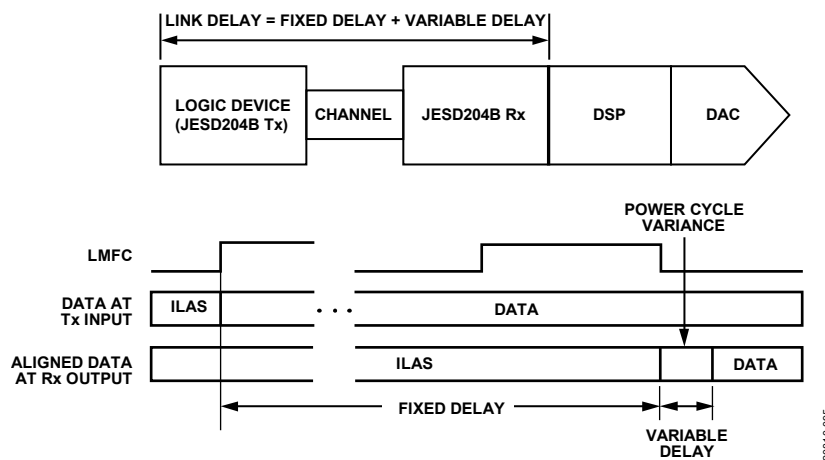

Figure 58. JESD204B Link Delay = Fixed Delay + Variable Delay

20810A-095

For proper functioning, all lanes on a link must be read during the same LMFC period. Section 6.1 of the JESD204B specification states that the LMFC period must be larger than the maximum link delay. For the AD9166, this is not necessarily the case. Instead, the AD9166 uses a local LMFC for each link (LMFC<sub>Rx</sub>) that can be delayed from the SYSREF± aligned LMFC.

Because the LMFC is periodic, this delay can account for any amount of fixed delay. As a result, the LMFC period must only be larger than the variation in the link delays, and the AD9166 can achieve proper performance with a smaller total latency.

Figure 59 and Figure 60 show a case where the link delay is greater than an LMFC period. Note that it can be accommodated by delaying LMFC<sub>Rx</sub>.

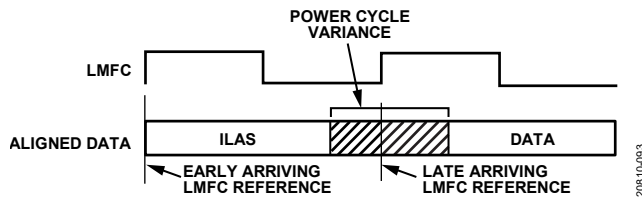

Figure 59. Link Delay > LMFC Period Example

The method to select the LMFCDel (Register 0x304), and LMFCVar (Register 0x306) variables is described in the Link Delay Setup Example, with Known Delays section.

Setting LMFCDel appropriately ensures that all the corresponding data samples arrive in the same LMFC period. Then, LMFCVar is written into the receive buffer delay to absorb all link delay variation. This write ensures that all data samples have arrived before reading. By setting these to fixed values across runs and devices, deterministic latency is achieved.

The receive buffer delay described in the JESD204B specification takes values from one frame clock cycle to K frame clock cycles, and the receive buffer delay of the AD9166 takes values from 0 PCLK cycles to 10 PCLK cycles. As a result, up to 10 PCLK cycles of total delay variation can be absorbed. LMFCVar and LMFCDel are both in PCLK cycles. The PCLK factor, or number of frame clock cycles per PCLK cycle, is equal to 4/F. For more information on this relationship, see the Clock Relationships section.

Two examples follow that show how to determine LMFCVar and LMFCDel. After they are calculated, write LMFCDel into Register 0x304 for all devices in the system, and write LMFCVar to Register 0x306 for all devices in the system.

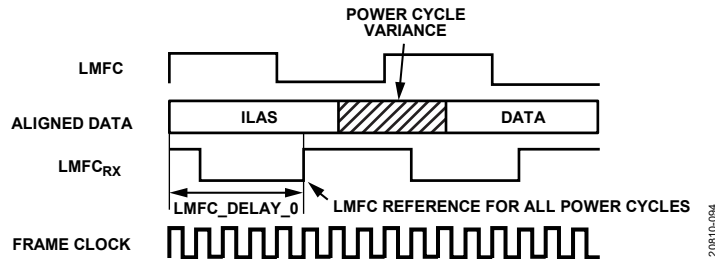

Figure 60. LMFC\_DELAY\_0 to Compensate for Link Delay > LMFC Period

**Link Delay Setup Example, with Known Delays**

All the known system delays can be used to calculate LMFCVar and LMFCDel. The example shown in Figure 61 is demonstrated in the following steps.

Note that this example is in Subclass 1 to achieve deterministic latency, which has a PCLK factor (4/F) of two frame clock cycles per PCLK cycle, and uses K = 32 (frames/multiframe). Because PCBFixed << PCLK Period, PCBFixed is negligible in this example and not included in the calculations.

1. Find the receiver delays using Table 6.  
 $RxFixed = 12$  PCLK cycles  
 $RxVar = 2$  PCLK cycles
2. Find the transmitter delays. The equivalent table in the example JESD204B core (implemented on a GTH or gigabit transceiver (GTX) on a Virtex-6 FPGA) states that the delay is  $56 \pm 2$  byte clock cycles.
3. Because the PCLK Rate = ByteRate/4 as described in the Clock Relationships section, the transmitter delays in PCLK cycles are calculated as follows:  
 $TxFixed = 54/4 = 13.5$  PCLK cycles  
 $TxVar = 4/4 = 1$  PCLK cycle

4. Calculate MinDelayLane as follows:  
 $MinDelayLane = \text{floor}(RxFixed + TxFixed + PCBFixed)$   
 $= \text{floor}(12 + 13.5 + 0)$   
 $= \text{floor}(25.5)$   
 $MinDelayLane = 25$
5. Calculate MaxDelayLane as follows:  
 $MaxDelayLane = \text{ceiling}(RxFixed + RxVar + TxFixed + TxVar + PCBFixed)$   
 $= \text{ceiling}(12 + 2 + 13.5 + 1 + 0)$   
 $= \text{ceiling}(28.5)$   
 $MaxDelayLane = 29$
6. Calculate LMFCVar as follows:  
 $LMFCVar = (MaxDelay + 1) - (MinDelay - 1)$   
 $= (29 + 1) - (25 - 1) = 30 - 24$   
 $LMFCVar = 6$  PCLK cycles
7. Calculate LMFCDel as follows:  
 $LMFCDel = (MinDelay - 1) \% (K/PclockFactor)$   
 $= ((30 - 1) \% (32/2))$   
 $= 29 \% 16$   
 $LMFCDel = 13$  PCLK cycles
8. Write LMFCDel to Register 0x304 for all devices in the system. Write LMFCVar to Register 0x306 for all devices in the system.

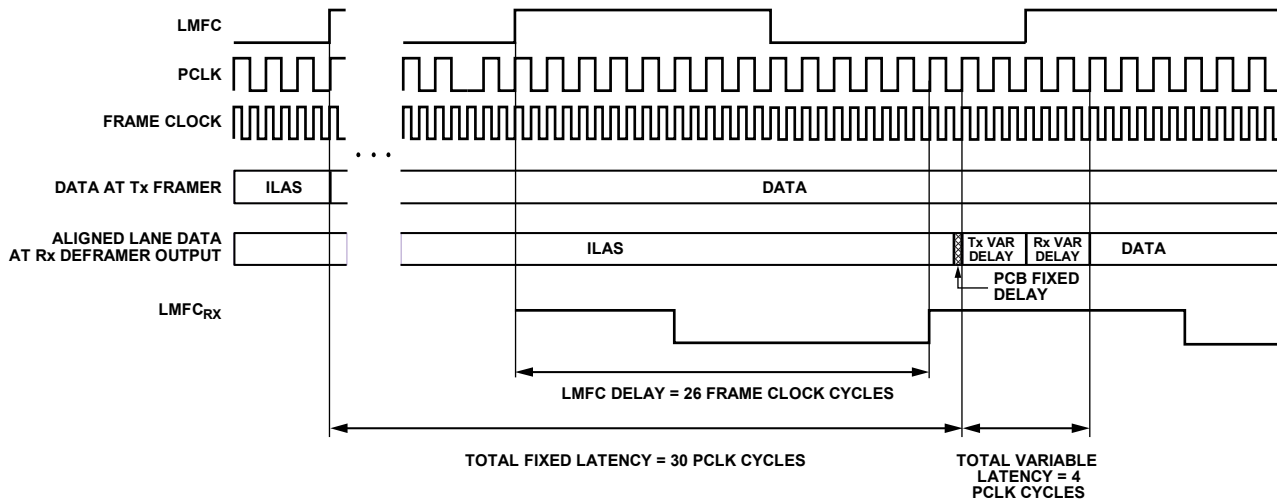

Figure 61. LMFC Delay Calculation Example

20810-098



**Link Delay Setup Example, Without Known Delay**

If the system delays are not known, the AD9166 can read back the link latency between LMFC<sub>RX</sub> for each link and the SYSREF± aligned LMFC. This information is then used to calculate LMFCVar and LMFCDel. Figure 62 shows how DYN\_LINK\_LATENCY\_0 (Register 0x302) provides a readback showing the delay (in PCLK cycles) between the LMFC<sub>RX</sub> and the transition from the ILAS to the first data sample. By repeatedly power cycling and taking this measurement, the minimum and maximum delays across power cycles can be determined to calculate LMFCVar and LMFCDel.

In Figure 62, the AD9166 is configured as described in the Sync Procedure section. Because the purpose of this exercise is to determine LMFCDel and LMFCVar, the LMFCDel value is programmed to 0 and the DYN\_LINK\_LATENCY\_0 value is read from Register 0x302. For Link A, Link B, and Link C, the system containing the AD9166 (including the transmitter) is power cycled and configured 20 times.

The variation in the link latency over the 20 runs is shown in Figure 62, described as follows:

- Link A gives readbacks of 6, 7, 0, and 1. Note that the set of recorded delay values rolls over the edge of a multiframe at the boundary of K/PCLK factor = 8. Add the number of PCLK cycles per multiframe = 8 to the readback values of 0 and 1 because they rolled over the edge of the multiframe. Delay values range from 6 to 9.

- Link B gives delay values from 5 to 7.
- Link C gives delay values from 4 to 7.

The example shown in Figure 62 is demonstrated in the following steps. Note that this example is in Subclass 1 to achieve deterministic latency, which has a PCLK factor (frame rate ÷ PCLK rate) of 4 and uses K = 32. Therefore, PCLK cycles per multiframe = 8.

1. Calculate the minimum of all delay measurements across all power cycles, links, and devices as follows:  
 $MinDelay = \min(\text{all Delay values}) = 4$
2. Calculate the maximum of all delay measurements across all power cycles, links, and devices as follows:  
 $MaxDelay = \max(\text{all Delay values}) = 9$
3. Calculate the total delay variation (with guard band) across all power cycles, links, and devices as follows:  
 $LMFCVar = (MaxDelay + 1) - (MinDelay - 1)$   
 $= (9 + 1) - (4 - 1) = 10 - 3 = 7 \text{ PCLK cycles}$
4. Calculate the minimum delay in PCLK cycles (with guard band) across all power cycles, links, and devices as follows:  
 $LMFCDel = (MinDelay - 1) \% (K/PCLK \text{ Factor})$   
 $= (4 - 1) \% 32/4$   
 $= 3 \% 8 = 3 \text{ PCLK cycles}$
5. Write LMFCDel to Register 0x304 for all devices in the system.
6. Write LMFCVar to Register 0x306 for all devices in the system.

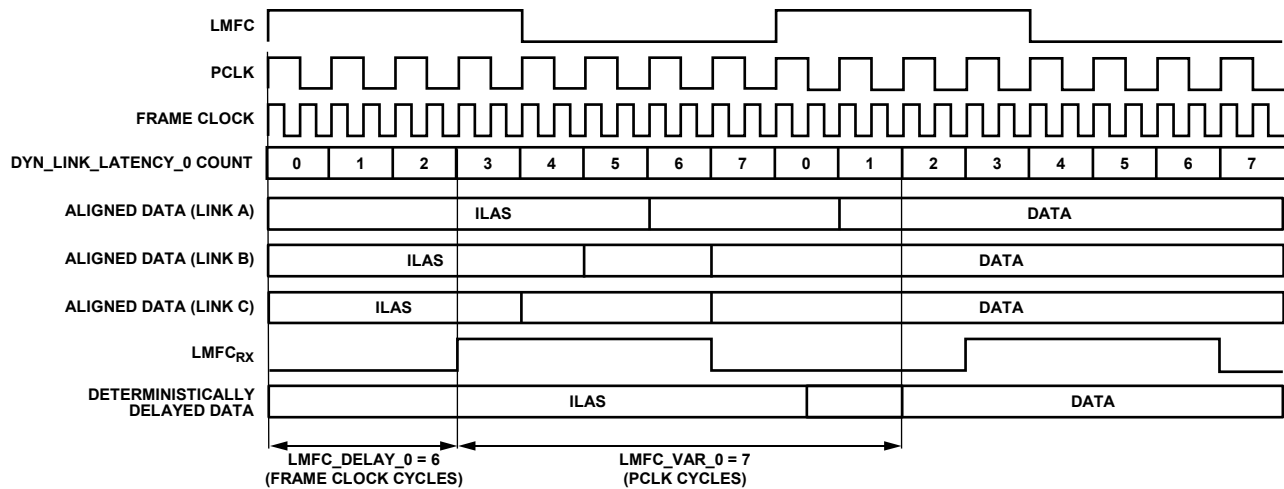

Figure 62. Multilink Synchronization Settings, Derived Method Example

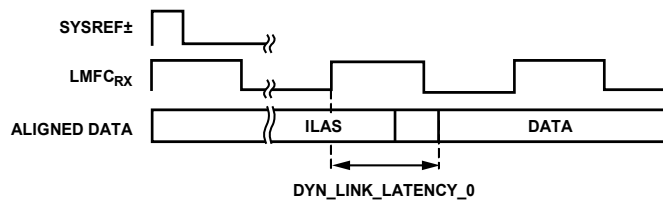
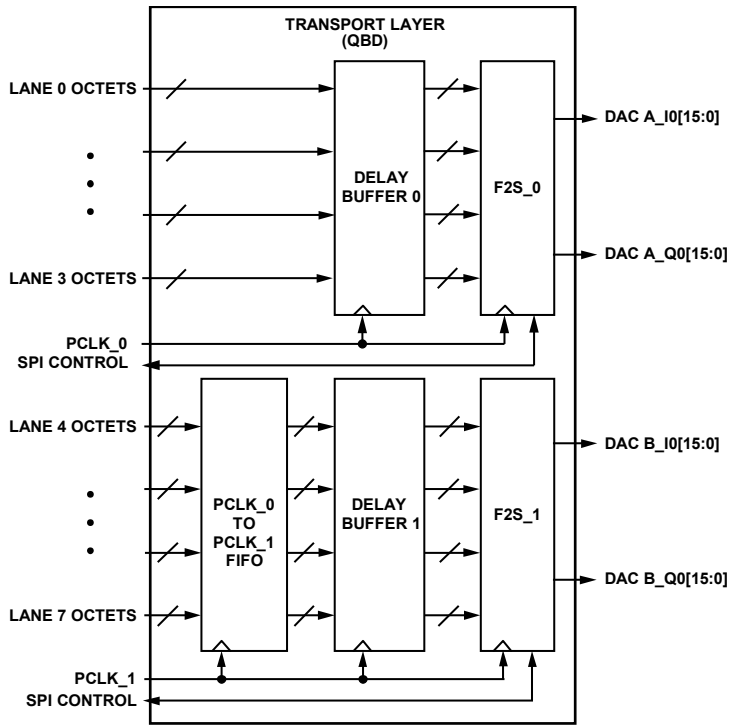

Figure 63. DYN\_LINK\_LATENCY\_0

TRANSPORT LAYER



NOTES  
F2S\_0 AND F2S\_1 ARE FRAME TO SAMPLE CONVERSION BLOCK 0 AND BLOCK 1.

201810-099

Figure 64. Transport Layer Block Diagram

The transport layer receives the descrambled JESD204B frames and converts them to DAC samples based on the programmed JESD204B parameters shown in Table 23. The device parameters are defined in Table 24.

Table 23. JESD204B Transport Layer Parameters

Parameter	Description
F	Number of octets per frame per lane: 1, 2, or 4
K	Number of frames per multiframe: K = 32
L	Number of lanes per converter device (per link), as follows: 4 or 8
M	Number of converters per device (per link), as follows: 1 or 2 (1 is used for real data mode; 2 is used for complex data modes)
S	Number of samples per converter, per frame: 1 or 2

Table 24. JESD204B Device Parameters

Parameter	Description
CF	Number of control words per device clock per link. Not supported, must be 0.
CS	Number of control bits per conversion sample. Not supported, must be 0.
HD	High density user data format. Used when samples must be split across lanes. Set to 1 always, even when F does not equal 1. Otherwise, a link configuration error triggers and the IRQ_ILAS flag is set.
N	Converter resolution = 16.
N' (or NP)	Total number of bits per sample = 16.

Certain combinations of these JESD2014B parameters are supported by the AD9166, as shown in Table 26 (JESD204B interpolation rate and number of lanes), Table 25 (fixed values), and Table 27 (supported and unsupported interpolation rates).

See Table 26 for a list of supported interpolation rates and the number of lanes that is supported for each rate. Table 26 lists the JESD204B parameters for each of the interpolation and number of lanes configuration, and gives an example lane rate for a 5 GHz device clock ( $f_{CLK}$ ).

Table 25 lists JESD204B parameters that have fixed values.

**Table 25. JESD204B Parameters with Fixed Values**

Parameter	Value
K	32
N	16
NP	16
CF	0
HD	1
CS	0

**Table 26. JESD204B Parameters for Interpolation Rate and Number of Lanes**

Interpolation Rate	No. of Lanes	M	F	S	PCLK Period ( $f_{CLK}$ Cycles)	LMFC Period ( $f_{CLK}$ Cycles)	Lane Rate at $f_{CLK} = 5$ GHz
1	8	1	1	4	16	128	12.5
2	6	2	2	3	12	192	16.66 <sup>1</sup>
2	8	2	1	2	16	128	12.5
3	6	2	2	3	18	288	11.11
3	8	2	1	2	24	192	8.33
4	3	2	4	3	12	384	16.66 <sup>1</sup>
4	4	2	1	1	16	128	12.5
4	6	2	2	3	24	384	8.33
4	8	2	1	2	32	256	6.25
6	3	2	4	3	18	576	11.11
6	4	2	1	1	24	192	8.33
6	6	2	2	3	36	576	5.55
6	8	2	1	2	48	384	4.16
8	2	2	2	1	16	256	12.5
8	3	2	4	3	24	768	8.33
8	4	2	1	1	32	256	6.25
8	6	2	2	3	48	768	4.16
8	8	2	1	2	64	512	3.12
12	2	2	2	1	24	384	8.33
12	3	2	4	3	36	1152	5.55
12	4	2	1	1	48	384	4.16
12	6	2	2	3	72	1152	2.77
12	8	2	1	2	96	768	2.08
16	1	2	4	1	16	512	12.5
16	2	2	2	1	32	512	6.25
16	3	2	4	3	48	1536	4.16
16	4	2	1	1	64	512	3.12
16	6	2	2	3	96	1536	2.08
16	8	2	1	2	128	1024	1.56
24	1	2	4	1	24	768	8.33
24	2	2	2	1	48	768	4.16
24	3	2	4	3	72	2304	2.77
24	4	2	1	1	96	768	2.08
24	6	2	2	3	144	2304	1.38
24	8	2	1	2	192	1536	1.04

<sup>1</sup> Maximum lane rate is 12.5 GHz. These modes must be run with the DAC rate below 3.75 GHz.

A value of yes in Table 27 means the interpolation rate is supported for the number of lanes. A blank cell means it is not supported.

**Table 27. Interpolation Rates and Number of Lanes**

Interpolation	8	6	4	3	2	1
1x	Yes <sup>1</sup>					
2x	Yes	Yes <sup>1</sup>				
3x	Yes	Yes				
4x	Yes	Yes	Yes	Yes <sup>1</sup>		
6x	Yes	Yes	Yes	Yes		
8x	Yes	Yes	Yes	Yes	Yes	
12x	Yes	Yes	Yes	Yes	Yes	
16x	Yes	Yes	Yes	Yes	Yes	Yes
24x	Yes	Yes	Yes	Yes	Yes	Yes

<sup>1</sup> These modes restrict the maximum device clock rate to 5 GHz.

### Configuration Parameters

The AD9166 modes refer to the link configuration parameters for L, K, M, N, NP, S, and F. Table 28 provides the description and addresses for these settings.

**Table 28. Configuration Parameters**

JESD204B Setting	Description	Address
L – 1	Number of lanes minus 1.	Register 0x453, Bits[4:0]
F – 1	Number of ((octets per frame) per lane) minus 1.	Register 0x454, Bits[7:0]
K – 1	Number of frames per multiframe minus 1.	Register 0x455, Bits[4:0]
M – 1	Number of converters minus 1.	Register 0x456, Bits[7:0]
N – 1	Converter bit resolution minus 1.	Register 0x457, Bits[4:0]
NP – 1	Bit packing per sample minus 1.	Register 0x458, Bits[4:0]
S – 1	Number of ((samples per converter) per frame) minus 1.	Register 0x459, Bits[4:0]
HD	High density format. Set to 1 if F = 1. Leave at 0 if F ≠ 1.	Register 0x45A, Bit 7
DID	Device ID. Match the device ID sent by the transmitter.	Register 0x450, Bits[7:0]
BID	Bank ID. Match the bank ID sent by the transmitter.	Register 0x451, Bits[7:0]
LID0	Lane ID for Lane 0. Match the Lane ID sent by the transmitter on Logical Lane 0.	Register 0x452, Bits[4:0]
JESDV	JESD204x version. Match the version sent by the transmitter (0x0 = JESD204A, 0x1 = JESD204B).	Register 0x459, Bits[7:5]

### Data Flow Through the JESD204B Receiver

The link configuration parameters determine how the serial bits on the JESD204B receiver interface are deframed and passed on to the DACs as data samples.

### Deskewing and Enabling Logical Lanes

After proper configuration, the logical lanes are automatically deskewed. All logical lanes are enabled or not based on the lane number setting in Register 0x110, Bits[7:4]. The physical lanes are all powered up by default.

To disable power to physical lanes that are not being used, set Bit x in Register 0x201 to 1 to disable Physical Lane x, and keep it at 0 to enable it.

### JESD204B TEST MODES

#### PHY PRBS Testing

The JESD204B receiver on the AD9166 includes a pseudorandom binary sequence (PRBS) pattern checker on the back end of its physical layer. This functionality enables bit error rate (BER) testing of each physical lane of the JESD204B link. The PHY PRBS pattern checker does not require that the JESD204B link be established. The pattern checker can synchronize with a PRBS7, PRBS15, or PRBS31 data pattern. The PRBS pattern can be verified on multiple lanes simultaneously. The error counts for failing lanes are reported for one JESD204B lane at a time.

**Table 29. PHY PRBS Pattern Selection**

PHY_PRBS_PAT_SEL Setting (Register 0x316, Bits[3:2])	PRBS Pattern
0b00 (default)	PRBS7
0b01	PRBS15
0b10	PRBS31

The process for performing PRBS testing on the AD9166 is as follows, using Table 29 for reference.

- Start sending a PRBS7, PRBS15, or PRBS31 pattern from the JESD204B transmitter.
- Select and write the appropriate PRBS pattern to Register 0x316, Bits[3:2], as shown in Table 29.
- Enable the PHY test for all lanes being tested by writing to PHY\_TEST\_EN (Register 0x315). Each bit of Register 0x315 enables the PRBS test for the corresponding lane. For example, writing a 1 to Bit 0 enables the PRBS test for Physical Lane 0.
- Toggle PHY\_TEST\_RESET (Register 0x316, Bit 0) from 0 to 1 then back to 0.
- Set PHY\_PRBS\_TEST\_THRESHOLD\_xBITS (Bits[23:0], Register 0x319 to Register 0x317) as desired.
- Write a 0 and then a 1 to PHY\_TEST\_START (Register 0x316, Bit 1). The rising edge of PHY\_TEST\_START starts the test.
  - (Optional) In some cases, it may be necessary to repeat Step 4 at this point. Toggle PHY\_TEST\_RESET (Register 0x316, Bit 0) from 0 to 1, then back to 0.
- Wait 500 ms.
- Stop the test by writing PHY\_TEST\_START (Register 0x316, Bit 1) = 0.

9. Read the PRBS test results.
  - a. Each bit of PHY\_PRBS\_PASS (Register 0x31D) corresponds to one SERDES lane (0 = fail, 1 = pass).
  - b. The number of PRBS errors seen on each failing lane can be read by writing the lane number (0 to 7) to PHY\_SRC\_ERR\_CNT (Register 0x316, Bits[6:4]) and reading the PHY\_PRBS\_ERR\_CNT\_xBITS (Register 0x31C to Register 0x31A). The maximum error count is  $2^{24-1}$ . If all bits of Register 0x31C to Register 0x31A are high, the maximum error count on the selected lane is exceeded.

**Transport Layer Testing**

The JESD204B receiver in the AD9166 supports the short transport layer test as described in the JESD204B standard. This test can be used to verify the data mapping between the JESD204B transmitter and receiver. To perform the short transport layer test, this function must be implemented in the logic device and enabled there. Before running the test on the receiver side, the link must be established and running without errors.

The short transport layer test ensures that each sample from each converter is mapped appropriately according to the number of converters (M) and the number of samples per converter (S). As specified in the JESD204B standard, the converter manufacturer specifies which test samples are transmitted. Each sample must have a unique value. For example, if M = 2 and S = 2, four unique samples are transmitted repeatedly until the test is stopped.

The expected sample must be programmed into the device and the expected sample is compared to the received sample, one sample at a time until all samples are tested. The process for performing this test on the AD9166 is described as follows:

1. Synchronize the JESD204B link.
2. Enable the short transport layer at the JESD204B transmitter.
3. Depending on JESD204B case, there may be up to two DACs, and each frame may contain up to four DAC samples. Configure the SHORT\_TPL\_REF\_SP\_MSB bits (Register 0x32E) and SHORT\_TPL\_REF\_SP\_LSB bits (Register 0x32D) to match one of the samples for one converter within one frame.
4. Set SHORT\_TPL\_SP\_SEL (Register 0x32C, Bits[7:4]) to select the sample within one frame for the selected converter according to Table 30.
5. Set SHORT\_TPL\_TEST\_EN (Register 0x32C, Bit 0) to 1.
6. Set SHORT\_TPL\_TEST\_RESET (Register 0x32C, Bit 1) to 1, then back to 0.
7. Wait for the desired time. The desired time is calculated as  $1/(\text{sample rate} \times \text{BER})$ . For example, given a bit error rate of  $\text{BER} = 1 \times 10^{-10}$  and a sample rate = 1 GSPS, the desired time = 10 sec. Then, set SHORT\_TPL\_TEST\_EN to 0.
8. Read the test result at SHORT\_TPL\_FAIL (Register 0x32F, Bit 0).
9. Choose another sample for the same or another converter to continue with the test, until all samples for both converters from one frame are verified. (Note that the converter count is M = 2 for all interpolator modes on the AD9166 to enable complex signal processing.)

Consult Table 30 for a guide to the test sample alignment. Note that the sample order for 1x, eight-lane mode has Sample 1 and Sample 2 swapped. Also, the short transport layer test for the three-lane and six-lane options is not functional and always fails.

**Table 30. Short Transport Layer Test Samples Assignment<sup>1</sup>**

JESD204x Mode	Required Samples from JESD204x Tx	Samples Assignment
1x Eight-Lane (L = 8, M = 1, F = 1, S = 4)	Send four samples: M0S0, M0S1, M0S2, M0S3, and repeat	SP0: M0S0, SP4: M0S0, SP8: M0S0, SP12: M0S0 SP1: M0S2, SP5: M0S2, SP9: M0S2, SP13: M0S2 SP2: M0S1, SP6: M0S1, SP10: M0S1, SP14: M0S1 SP3: M0S3, SP7: M0S3, SP11: M0S3, SP15: M0S3
2x Eight-Lane (L = 8, M = 2, F = 1, S = 2) 3x Eight-Lane (L = 8, M = 2, F = 1, S = 2) 4x Eight-Lane (L = 8, M = 2, F = 1, S = 2) 6x Eight-Lane (L = 8, M = 2, F = 1, S = 2) 8x Eight-Lane (L = 8, M = 2, F = 1, S = 2) 12x Eight-Lane e (L = 8, M = 2, F = 1, S = 2) 16x Eight-Lane (L = 8, M = 2, F = 1, S = 2) 24x Eight-Lane (L = 8, M = 2, F = 1, S = 2)	Send four samples: M0S0, M0S1, M1S0, M1S1, and repeat	SP0: M0S0, SP4: M0S0, SP8: M0S0, SP12: M0S0 SP1: M1S0, SP5: M1S0, SP9: M1S0, SP13: M1S0 SP2: M0S1, SP6: M0S1, SP10: M0S1, SP14: M0S1 SP3: M1S1, SP7: M1S1, SP11: M1S1, SP15: M1S1
2x Six-Lane (L = 6, M = 2, F = 2, S = 3) 3x Six-Lane (L = 6, M = 2, F = 2, S = 3) 4x Six-Lane (L = 6, M = 2, F = 2, S = 3) 6x Six-Lane (L = 6, M = 2, F = 2, S = 3)	Send six samples: M0S0, M0S1, M0S2, M1S0, M1S1, M1S2, and repeat	Test hardware is not functional; short transport layer always fails

JESD204x Mode	Required Samples from JESD204x Tx	Samples Assignment
8× Six-Lane (L = 6, M = 2, F = 2, S = 3) 12× Six-Lane (L = 6, M = 2, F = 2, S = 3) 16× Six-Lane (L = 6, M = 2, F = 2, S = 3) 24× Six-Lane (L = 6, M = 2, F = 2, S = 3) 4× Three-Lane (L = 3, M = 2, F = 4, S = 3) 6× Three-Lane (L = 3, M = 2, F = 4, S = 3) 8× Three-Lane (L = 3, M = 2, F = 4, S = 3) 12× Three-Lane (L = 3, M = 2, F = 4, S = 3) 16× Three-Lane (L = 3, M = 2, F = 4, S = 3) 24× Three-Lane (L = 3, M = 2, F = 4, S = 3)		
4× Four-Lane (L = 4, M = 2, F = 1, S = 1) 6× Four-Lane (L = 4, M = 2, F = 1, S = 1) 8× Four-Lane (L = 4, M = 2, F = 1, S = 1) 12× Four-Lane (L = 4, M = 2, F = 1, S = 1) 16× Four-Lane (L = 4, M = 2, F = 1, S = 1) 24× Four-Lane (L = 4, M = 2, F = 1, S = 1) 8× Two-Lane (L = 2, M = 2, F = 2, S = 1) 12× Two-Lane (L = 2, M = 2, F = 2, S = 1) 16× Two-Lane (L = 2, M = 2, F = 2, S = 1) 24× Two-Lane (L = 2, M = 2, F = 2, S = 1) 16× One-Lane (L = 1, M = 2, F = 4, S = 1) 24× One-Lane (L = 1, M = 2, F = 4, S = 1)	Send two samples: M0S0, M1S0, repeat	SP0: M0S0, SP4: M0S0, SP8: M0S0, SP12: M0S0 SP1: M1S0, SP5: M1S0, SP9: M1S0, SP13: M1S0 SP2: M0S0, SP6: M0S0, SP10: M0S0, SP14: M0S0 SP3: M1S0, SP7: M1S0, SP11: M1S0, SP15: M1S0

<sup>1</sup> Mx is the converter number and Sy is the sample number. For example, M0S0 means Converter 0, Sample 0. SPx is the sample pattern word number. For example, SP0 means Sample Pattern Word 0.

### Repeated CGS and ILAS Test

As per Section 5.3.3.8.2 of the JESD204B specification, the AD9166 can check that a constant stream of /K28.5/ characters is being received, or that code group synchronization (CGS) followed by a constant stream of ILAS is being received.

To run a repeated CGS test, send a constant stream of /K28.5/ characters to the AD9166 SERDES inputs. Next, set up the device and enable the links. Ensure that the /K28.5/ characters are being received by verifying that  $\overline{\text{SYNCOUT}}_{\pm}$  is deasserted and that CGS has passed for all enabled link lanes by reading Register 0x470.

To run the CGS followed by a repeated ILAS sequence test, follow the procedure to set up the links. However, before performing the last write (enabling the links), enable the ILAS test mode by writing a 1 to Register 0x477, Bit 7. Then, enable the links. When the device recognizes four CGS characters on each lane, it deasserts the  $\overline{\text{SYNCOUT}}_{\pm}$ . At this point, the transmitter starts sending a repeated ILAS sequence.

Read Register 0x473 to verify that initial lane synchronization has passed for all enabled link lanes.

### JESD204B ERROR MONITORING

#### Disparity, Not in Table, and Unexpected Control (K) Character Errors

As per Section 7.6 of the JESD204B specification, the AD9166 can detect disparity errors, not in table (NIT) errors, and unexpected control (K) character errors, and can optionally issue a sync request and reinitialize the link when errors occur.

Note that the disparity error counter counts all characters with invalid disparity, regardless of whether they are in the 8-bit/10-bit decoding table. This error counting method is a minor deviation from the JESD204B specification, which only counts disparity errors when they are in the 8-bit/10-bit decoding table.

Several other interpretations of the JESD204B specification are noted in this section. When three NIT errors are injected to one lane and QUAL\_RDERR (Register 0x476, Bit 4) = 1, the readback values of the bad disparity error (BDE) count register is 1. Reporting of disparity errors that occur at the same character position of a NIT error is disabled. No such disabling is performed for the disparity errors in the characters after a NIT error. Therefore, it is expected behavior that a NIT error may result in a BDE error.

A resync is triggered when four NIT errors are injected with Register 0x476, Bit 4 = 1. When this bit is set, the error counter does not distinguish between a concurrent invalid symbol with the wrong running disparity but is in the 8-bit/10-bit decoding table, and a NIT error. Thus, a resync can be triggered when

four NIT errors are injected because they are not distinguished from disparity errors.

### Checking Error Counts

The error count can be checked for BDEs, NIT errors, and unexpected K (UEK) character errors. The error counts are on a per lane and per error type basis. Each error type and lane has a register dedicated to it. To check the error count, the following steps must be performed:

1. Choose and enable the type of errors to monitor by selecting them in Register 0x480, Bits[5:3] to Register 0x487, Bits[5:3]. UEK, BDE, and NIT error monitoring can be selected for each lane by writing a 1 to the appropriate bit, as described in the register map. These bits are enabled by default.
2. The corresponding error counter reset bits are in Register 0x480, Bits[2:0] to Register 0x487, Bits[2:0]. Write a 0 to the corresponding bit to reset that error counter.
3. Registers 0x488, Bits[2:0] to Register 0x48F, Bits[2:0] have the terminal count hold indicator for each error counter. If this flag is enabled, when the terminal error count of 0xFF is reached, the counter ceases counting and holds that value until reset. Otherwise, it wraps to 0x00 and continues counting. Select the desired behavior, and program the corresponding register bits per lane.

### Check for Error Count Overthreshold

To check for the error count over threshold, follow these steps:

1. Define the error counter threshold. The error counter threshold can be set to a user defined value in Register 0x47C, or remain at the default value of 0xFF. When the error threshold is reached, an IRQ is generated,  $\overline{\text{SYNCOUT}}_{\pm}$  is asserted, or both, depending on the mask register settings. This single error threshold is used for all three types of errors (UEK, NIT, and BDE).
2. Set the SYNC\_ASSERT\_MASK bits. The  $\overline{\text{SYNCOUT}}_{\pm}$  assertion behavior is set in Register 0x47D, Bits[2:0]. By default, when any error counter of any lane is equal to the threshold, it asserts  $\overline{\text{SYNCOUT}}_{\pm}$  (Register 0x47D, Bits[2:0] = 0b111).
3. Read the indicator for error count reached. Each error counter has an indicator for when a terminal count is reached, per lane. This indicator is set to 1 when the terminal count of an error counter for a particular lane has been reached. These status bits are located in Register 0x490, Bits[2:0] to Register 0x497, Bits[2:0]. These registers also indicate whether a particular lane is active by setting Bit 3 = 0b1.

### Error Counter and Interrupt Request Control

For error counter and interrupt request control, follow these steps:

1. Enable the interrupts. Enable the JESD204B interrupts. The interrupts for the UEK, NIT, and BDE error counters are in Register 0x4B8, Bits[7:5]. There are other interrupts to monitor when bringing up the link, such as interlane deskewing, initial lane sync, good check sum, frame sync, code group sync (Register 0x4B8, Bits[4:0]), and configuration mismatch (Register 0x4B9, Bit 0). These bits are off by default but can be enabled by writing 0b1 to the corresponding bit.
2. Read the JESD204B interrupt status. The interrupt status bits are in Register 0x4BA, Bits[7:0] and Register 0x4BB, Bit 0, with the status bit position corresponding to the enable bit position.
3. It is recommended to enable all interrupts that are planned to be used prior to bringing up the JESD204B link. When the link is up, the interrupts can be reset and then used to monitor the link status.

### Monitoring Errors via $\overline{\text{SYNCOUT}}_{\pm}$

As per the JESD204B specifications, when one or more BDE, NIT, or unexpected control character (including UEK) errors occur, the error is reported on the  $\overline{\text{SYNCOUT}}_{\pm}$  pin by asserting the  $\overline{\text{SYNCOUT}}_{\pm}$  signal for exactly two frame periods. For the AD9166, the width of the  $\overline{\text{SYNCOUT}}_{\pm}$  pulse can be programmed to  $\frac{1}{2}$ , 1, or 2 PCLK cycles. The settings to achieve a  $\overline{\text{SYNCOUT}}_{\pm}$  pulse of two frame clock cycles are listed in Table 31.

**Table 31. Setting  $\overline{\text{SYNCOUT}}_{\pm}$  Error Pulse Duration**

F <sup>1</sup>	PCLK Factor (Frames per PCLK)	SYNC_ERR_DUR (Register 0x312, Bits[7:4]) Setting <sup>2</sup>
1	4	0 (default)
2	2	1
4	1	2

<sup>1</sup> F is a link configuration parameter (see Table 28).

<sup>2</sup> These register settings assert the  $\overline{\text{SYNCOUT}}_{\pm}$  signal for two frame clock cycle pulse widths.

### UEK, NIT, and BDE IRQs

For UEK, NIT, and BDE errors, error count overthreshold events are available as IRQ events. Enable these events by writing to Register 0x4B8, Bits[7:5]. After the IRQs are enabled, the IRQ event status can be read at Register 0x4BA, Bits[7:5].

See the Interrupt Request Operation section for more information on IRQs and see the Error Counter and Interrupt Request Control section for information on resetting the IRQ.

### Errors Requiring Reinitializing

A link reinitialization automatically occurs when four invalid disparity characters are received per the JESD204B specification. When a link reinitialization occurs, the resync request is five frames and nine octets long.

The user can optionally reinitialize the link when the error count for disparity errors, NIT errors, or UEK character errors reaches a programmable error threshold. The process to enable the reinitialization feature for certain error types is as follows:

1. Choose and enable which errors to monitor by selecting them in Register 0x480, Bits[5:3] to Register 0x487, Bits[5:3]. UEK, BDE, and NIT error monitoring can be selected for each lane by writing a 1 to the appropriate bit, as described in Table 46. These bits are enabled by default.
2. Enable the sync assertion mask for each type of error by writing to SYNC\_ASSERT\_MASK (Register 0x47D, Bits[2:0]) according to Table 32.
3. Program the desired error counter threshold into ERRORTHRES (Register 0x47C).
4. For each error type enabled in the SYNC\_ASSERT\_MASK register, if the error counter on any lane reaches the programmed threshold, SYNCOUT± falls, issuing a sync request. Note that all error counts are reset when a link reinitialization occurs. The IRQ does not reset and must be reset manually.

**Table 32. Sync Assertion Mask (SYNC\_ASSERT\_MASK, Address 0x47D)**

Bit No.	Bit Name	Description
2	UEK	Set to 1 to assert SYNCOUT± if the UEK character error count reaches the threshold
1	NIT	Set to 1 to assert SYNCOUT± if the NIT error count reaches the threshold
0	BDE	Set to 1 to assert SYNCOUT± if the disparity error count reaches the threshold

### CGS, Frame Sync, Checksum, and ILAS Monitoring

Monitor Register 0x470 to Register 0x473 to verify that each stage of the JESD204B link establishment has occurred.

Bit x of CODE\_GRP\_SYNC (Register 0x470) is high if Link Lane x received at least four K28.5 characters and passed CGS.

Bit x of FRAME\_SYNC (Register 0x471) is high if Link Lane x completed initial frame synchronization.

Bit x of GOOD\_CHECKSUM (Register 0x472) is high if the checksum sent over the lane matches the sum of the JESD204B parameters sent over the lane during ILAS for Link Lane x. The parameters can be added either by summing the individual fields in registers or summing the packed register. If Register 0x300, Bit 6 = 0 (default), the calculated checksums are the lower eight bits of the sum of the following fields: DID, BID, LIDx, SCR, L – 1, F – 1, K – 1, M – 1, N – 1, SUBCLASSV, NP – 1, JESDV, S – 1, and HD. If Register 0x300, Bit 6 = 1, the calculated checksums are the lower eight bits of the sum of Register 0x400 to Register 0x40C and LIDx, where x refers to a Link Lane x.

Bit x of INIT\_LANE\_SYNC (Register 0x473) is high if Link Lane x passed the initial lane alignment sequence.

### CGS, Frame Sync, Checksum, and ILAS IRQs

Fail signals for CGS, frame sync, checksum, and ILAS are available as IRQ events. Enable them by writing to Register 0x4B8, Bits[3:0]. The IRQ event status can be read at Register 0x4BA, Bits[3:0] after the IRQs are enabled.

- Write a 1 to Register 0x4BA, Bit 0 to reset the CGS IRQ.
- Write a 1 to Register 0x4BA, Bit 1 to reset the frame sync IRQ.
- Write a 1 to Register 0x4BA, Bit 2 to reset the checksum IRQ.
- Write a 1 to Register 0x4BA, Bit 3 to reset the ILAS IRQ.

See the Interrupt Request Operation section for more information.

### Configuration Mismatch IRQ

The AD9166 has a configuration mismatch flag that is available as an IRQ event. Use Register 0x4B9, Bit 0 to enable the mismatch flag (it is enabled by default), and then use Register 0x4BB, Bit 0 to read back its status and reset the IRQ signal. See the Interrupt Request Operation section for more information.

The configuration mismatch event flag is high when the link configuration settings (in Register 0x450 to Register 0x45D) do not match the JESD204B transmitted settings (Register 0x400 to Register 0x40D).

This function is different from the good checksum flags in Register 0x472. The good checksum flags ensure that the transmitted checksum matches a calculated checksum based on the transmitted settings. The configuration mismatch event ensures that the transmitted settings match the configured settings.

### HARDWARE CONSIDERATIONS

See the Applications Information section for information on hardware considerations.



## MAIN DIGITAL DATAPATH

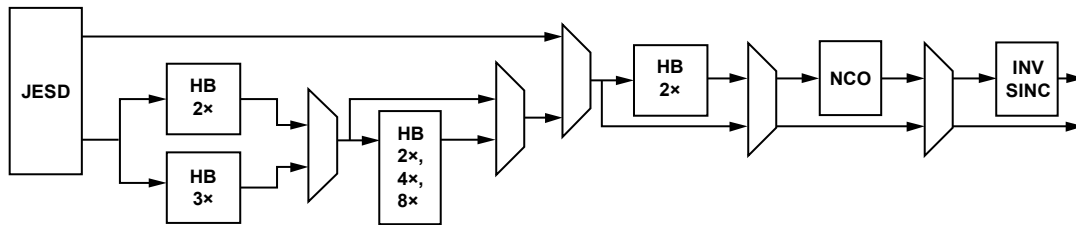

Figure 65. Block Diagram of the Main Digital Datapath

The block diagram in Figure 65 shows the functionality of the main digital datapath. The digital processing includes an input interpolation block with choice of bypass 1 $\times$ , 2 $\times$ , or 3 $\times$  interpolation, three additional 2 $\times$  half-band interpolation filters, a final 2 $\times$  NRZ mode interpolator filter, FIR85, that can be bypassed, and a quadrature modulator that consists of a 48-bit NCO and an inverse sinc block.

All of the interpolation filters accept I and Q data streams as a complex data stream. Similarly, the quadrature modulator and inverse sinc function also accept input data as a complex data stream. Thus, any use of the digital datapath functions requires the input data to be a complex data stream.

In bypass mode (1 $\times$  interpolation), the input data stream is expected to be real data.

**Table 33. Pipeline Delay (Latency) for Various Datapath Configurations**

Mode	FIR85 On	Filter Bandwidth	Inverse Sinc	NCO	Pipeline Delay <sup>1</sup> ( $f_{CLK}$ Cycles)
NCO only	No	N/A <sup>2</sup>	No	Yes	48
1 $\times$ (Bypass)	No	N/A <sup>2</sup>	No	No	113
1 $\times$ (Bypass)	No	N/A <sup>2</sup>	Yes	No	137
2 $\times$	No	80%	No	No	155
2 $\times$	No	90%	No	No	176
2 $\times$	Yes	80%	No	No	202
2 $\times$	No	80%	Yes	No	185
2 $\times$	Yes	80%	Yes	No	239
2 $\times$	Yes	80%	Yes	Yes	279
3 $\times$	No	80%	No	No	168
3 $\times$	No	90%	No	No	202
4 $\times$	No	80%	No	No	308
6 $\times$	No	80%	No	No	332
8 $\times$	No	80%	No	No	602
12 $\times$	No	80%	No	No	674
16 $\times$	No	80%	No	No	1188
24 $\times$	No	80%	No	No	1272

<sup>1</sup> The pipeline delay given is a representative number, and may vary by a cycle or two based on the internal handoff timing conditions at startup.

<sup>2</sup> N/A means not applicable.

The pipeline delay changes based on the digital datapath functions that are selected. See Table 33 for examples of the pipeline delay per block. These delays are in addition to the JESD204B latency.

## DATA FORMAT

The input data format for all modes on the AD9166 is 16-bit, twos complement. The digital datapath and the DAC decoder operate in twos complement format. The DAC is a current steering DAC and cannot represent 0. The DAC must either source or sink current. As a result, when the 0 of twos complement is represented in the DAC, it is a +1, and all the positive values thereafter are shifted by +1. This mapping error introduces a  $\frac{1}{2}$  LSB shift in the DAC output. The leakage can become apparent when using the NCO to shift a signal that is above or below 0 Hz when synthesized. The NCO frequency is seen as a small spur at the NCO frequency tuning word.

To avoid the NCO frequency leakage, operate the DAC with a slight digital backoff of one or several codes, and then add 1 to all values in the data stream. These actions remove the NCO frequency leakage but cause a  $\frac{1}{2}$  LSB dc offset. This small dc offset is benign to the DAC and does not affect most applications because the DAC output is ac-coupled through dc blocking capacitors.

## INTERPOLATION FILTERS

The main digital path contains five half-band interpolation filters, plus a final half-band interpolation filter that is used in 2 $\times$  NRZ mode. The filters are cascaded, as shown in Figure 65.

The first pair of filters is a 2 $\times$  (HB2) or 3 $\times$  (HB3) filter. Each of these filters has two options for bandwidth, 80% or 90%. The 80% filters are lower power than the 90% filters. The filters default to the lower power 80% bandwidth. To select the filter bandwidth as 90%, program the FILT\_BW bit in the DATAPATH\_CFG register to 1 (Register 0x111, Bit 4 = 0b1).

Following the first pair of filters is a series of 2 $\times$  half-band filters, each of which halves the usable bandwidth of the previous one. HB4 has 45%, HB5 has 22.5%, and HB6 has 11.25% of the  $f_{DATA}$  bandwidth.

The final half-band filter, FIR85, is used in 2 $\times$  NRZ mode. FIR85 is clocked at the  $2 \times f_{CLK}$  rate and has a usable bandwidth of 45% of the  $f_{CLK}$  rate. The FIR85 filter is a complex filter, and therefore the bandwidth is centered at 0 Hz. The FIR85 filter is used in conjunction with the complex interpolation modes to allow doubling the DAC update rate, thus moving the image spur further from the signal. Table 34 shows how to select each available interpolation mode, their usable bandwidths, and their

maximum data rates. Calculate the available signal bandwidth,  $BW_{SIGNAL}$ , as follows:

$$BW_{SIGNAL} = BW_{FILT} \times (f_{CLK}/InterpolationFactor)$$

where  $BW_{FILT}$  is the interpolator filter bandwidth.

**Filter Performance**

The interpolation filters interpolate between existing data in such a way that they minimize changes in the incoming data while suppressing the creation of interpolation images. This datapath is shown for each filter in Figure 66.

The usable bandwidth (as shown in Table 34) is defined as the frequency band over which the filters have a pass-band ripple of less than  $\pm 0.001$  dB and an image rejection of greater than 85 dB. A conceptual drawing that shows the relative bandwidth of each of the filters is shown in Figure 66. The maximum pass band amplitude of all filters is the same. They are different in the illustration to improve understanding.

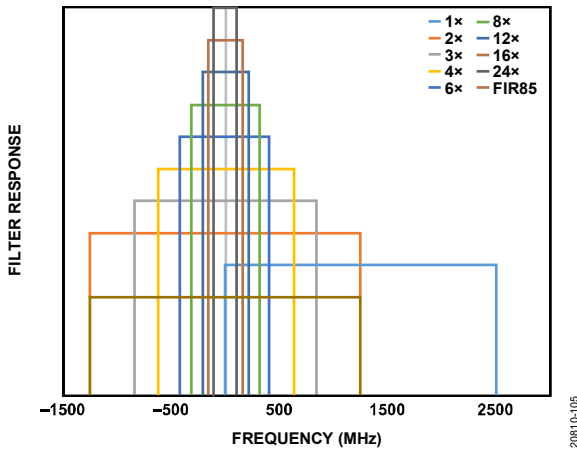

Figure 66. All Band Responses of Interpolation Filters

**Filter Performance Beyond Specified Bandwidth**

Some of the interpolation filters are specified to  $0.4 \times f_{DATA}$  (with a pass band). The filters can be used slightly beyond this ratio at the expense of increased pass-band ripple and decreased interpolation image rejection.

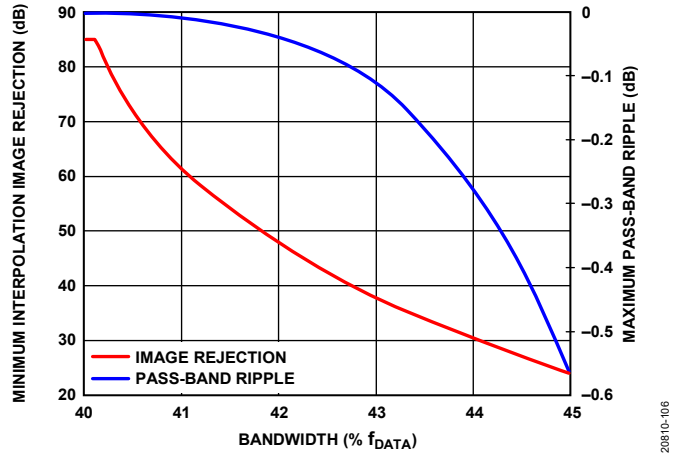

Figure 67. Interpolation Filter Performance Beyond Specified Bandwidth for the 80% Filters

Figure 67 shows the performance of the interpolation filters beyond  $0.4 \times f_{DATA}$ . The ripple increases more slowly than the image rejection decreases. This means that if the application can tolerate degraded image rejection from the interpolation filters, more bandwidth can be used.

Most of the filters are specified to  $0.45 \times f_{DATA}$  (with pass band). Figure 68 to Figure 75 show the filter response for each of the interpolator filters on the AD9166.

**Table 34. Interpolation Modes and Usable Bandwidth**

Interpolation Mode	INTERP_MODE, Register 0x110, Bits[3:0]	Available Signal Bandwidth <sup>1</sup>	Maximum $f_{DATA}$ (MHz)
1x (Bypass)	0x00	$f_{DAC}/2$	$f_{DAC}^2$
2x	0x01	$Bandwidth \times f_{DATA}/2$	$f_{DAC}/2^2$
3x	0x02	$Bandwidth \times f_{DATA}/2$	$f_{DAC}/3$
4x	0x03	$Bandwidth \times f_{DATA}/2$	$f_{DAC}/4$
6x	0x04	$Bandwidth \times f_{DATA}/2$	$f_{DAC}/6$
8x	0x05	$Bandwidth \times f_{DATA}/2$	$f_{DAC}/8$
12x	0x06	$Bandwidth \times f_{DATA}/2$	$f_{DAC}/12$
16x	0x07	$Bandwidth \times f_{DATA}/2$	$f_{DAC}/16$
24x	0x08	$Bandwidth \times f_{DATA}/2$	$f_{DAC}/24$
2x NRZ (Register 0x111, Bit 0 = 1)	Any combination <sup>3</sup>	$0.45 \times f_{CLK}^4$	$f_{CLK}$ (real) or $f_{CLK}/2$ (complex) <sup>2</sup>

<sup>1</sup> The data rate ( $f_{DATA}$ ) for all interpolator modes is a complex data rate, meaning both I data and Q data run at that rate. The available signal bandwidth is the data rate multiplied by the bandwidth of the initial 2x or 3x interpolator filters, which can be set to bandwidth = 80% or bandwidth = 90%. This bandwidth is centered at 0 Hz.

<sup>2</sup> The maximum speed for 1x and 2x interpolation is limited by the JESD204B interface.

<sup>3</sup> The 2x NRZ filter, FIR85, can be used with any of the interpolator combinations.

<sup>4</sup> The bandwidth of the FIR85 filter is centered at 0 Hz.

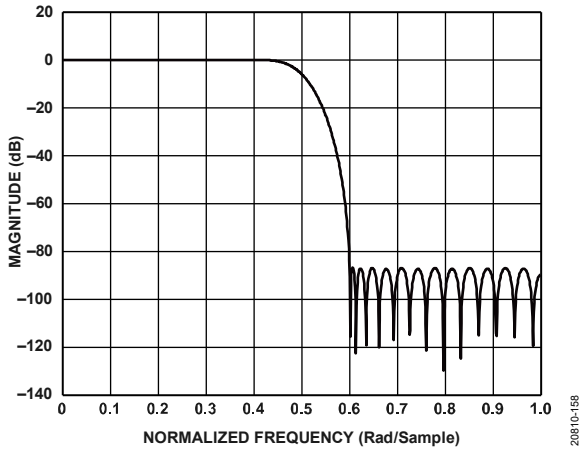

Figure 68. First 2x Half-Band 80% Filter Response

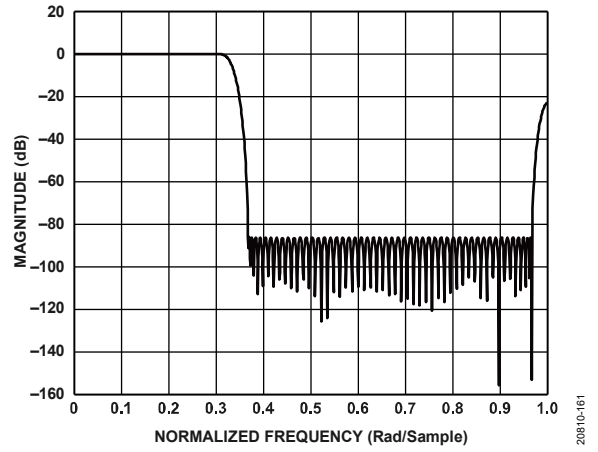

Figure 71. 3x Third-Band 90% Filter Response

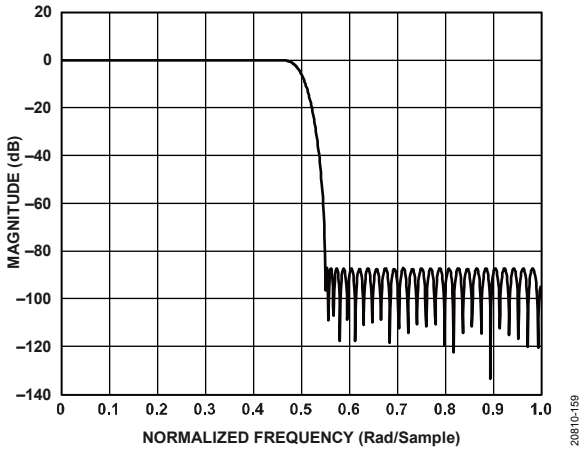

Figure 69. First 2x Half-Band 90% Filter Response

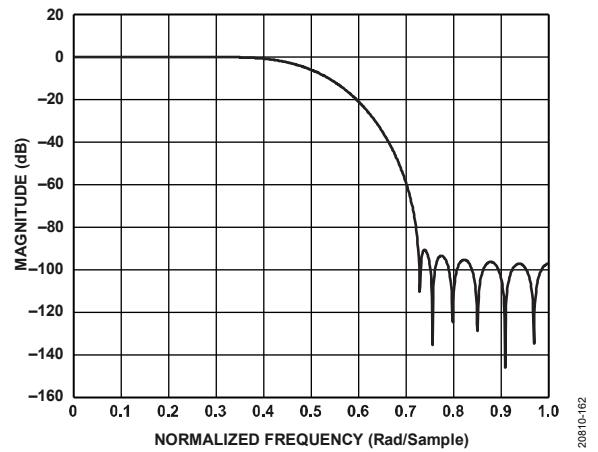

Figure 72. Second 2x Half-Band 45% Filter Response

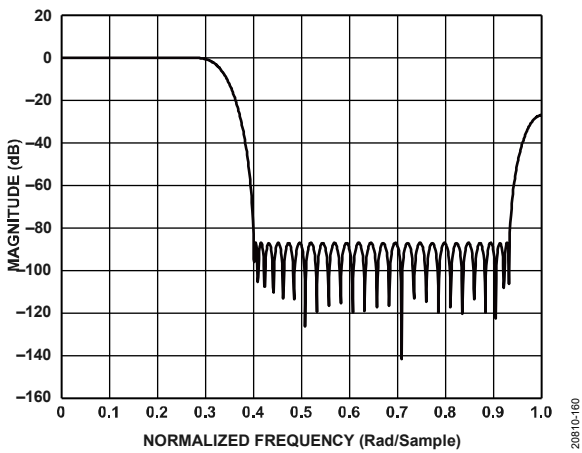

Figure 70. 3x Third-Band 80% Filter Response

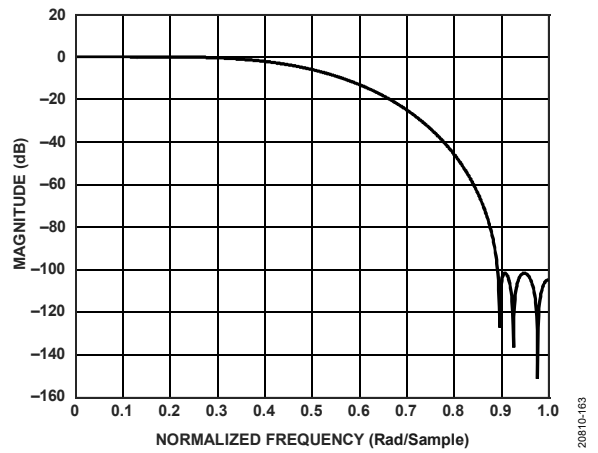

Figure 73. Third 2x Half-Band 22.5% Filter Response

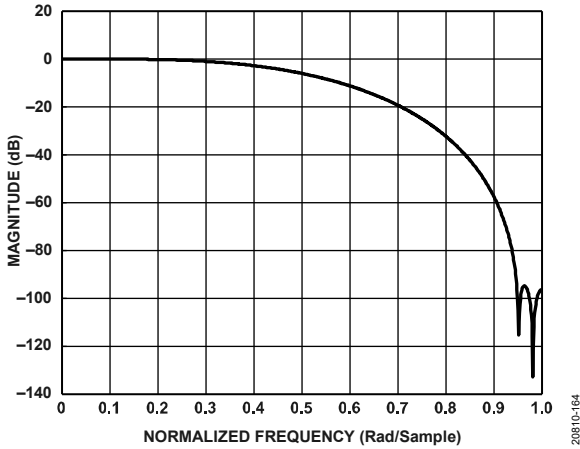

Figure 74. Fourth 2x Half-Band 11.25% Filter Response

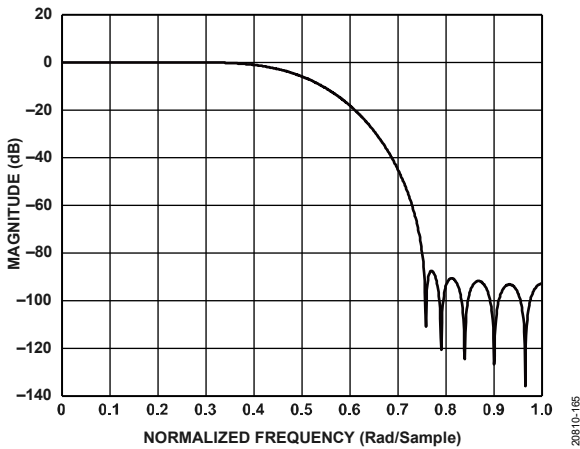

Figure 75. FIR85 2x Half-Band 45% Filter Response

**DIGITAL MODULATION**

The AD9166 has digital modulation features to modulate the baseband quadrature signal to the desired DAC output frequency.

The AD9166 is equipped with several NCO modes. The default NCO is a 48-bit, integer NCO. The A/B ratio of the dual-modulus NCO allows the output frequency to be synthesized with very fine precision. NCO mode is selected, as shown in Table 35.

**Table 35. Modulation Mode Selection**

Modulation Mode	Modulation Type	
	Register 0x111, Bit 6	Register 0x111, Bit 2
None	0b0	0b0
48-Bit Integer NCO	0b1	0b0
48-Bit Dual-Modulus NCO	0b1	0b1
32-Bit FFH NCO <sup>1</sup>	0b1	0b1

<sup>1</sup> The FFH NCOs are enabled by writing a nonzero word to their frequency tuning word registers when the main 48-bit NCO is enabled (see the Fast Frequency Hopping (FFH) section). The modulus can be enabled or disabled. If the modulus is enabled, the same modulus ratio applies to all the NCOs.

**48-Bit Dual Modulus NCO**

This modulation mode uses an NCO, a phase shifter, and a complex modulator to modulate the signal by a programmable carrier signal as shown in Figure 76. This configuration allows output signals to be placed anywhere in the output spectrum with very fine frequency resolution.

The NCO produces a quadrature carrier to translate the input signal to a new center frequency. A quadrature carrier is a pair of sinusoidal waveforms of the same frequency, offset 90° from each other. The frequency of the quadrature carrier is set via an FTW. The quadrature carrier is mixed with the I and Q data and then summed into the I and Q datapaths, as shown in Figure 76.

**Integer NCO Mode**

The main 48-bit NCO can be used as an integer NCO by using the following formula to create the FTW:

$$-f_{CLK}/2 \leq f_{CARRIER} < +f_{CLK}/2$$

$$FTW = (f_{CARRIER}/f_{CLK}) \times 2^{48}$$

where:

$f_{CARRIER}$  is the carrier frequency.

$FTW$  is a 48-bit, twos complement number.

When in 2x NRZ mode (FIR85 enabled with Register 0x111, Bit 0 = 1), the frequency tuning word is calculated as

$$0 \leq f_{CARRIER} < f_{CLK}$$

$$FTW = (f_{CARRIER}/f_{CLK}) \times 2^{48}$$

where  $FTW$  is a 48-bit binary number.

This method to calculate the FTW for 2x NRZ mode allows the tone to correctly move from 0 Hz toward  $f_{CLK}$  when the FTW is incremented. Use this method only for 2x NRZ mode. If the desired tone is placed between  $f_{CLK}/2$  and  $f_{CLK}$  and the FIR85 enable bit is set to 0b0 without adjusting the FTW, the tone may appear to change location to a new frequency.

The FTW is set as shown in Table 36.

**Table 36. NCO FTW Registers**

Address	Value	Description
0x114	FTW[7:0]	8 LSBs of FTW
0x115	FTW[15:8]	Next 8 bits of FTW
0x116	FTW[23:16]	Next 8 bits of FTW
0x117	FTW[31:24]	Next 8 bits of FTW
0x118	FTW[39:32]	Next 8 bits of FTW
0x119	FTW[47:40]	8 MSBs of FTW

Unlike other registers, the FTW registers are not updated immediately upon writing. Instead, the FTW registers update on the rising edge of FTW\_LOAD\_REQ (Register 0x113, Bit 0). After an update request, FTW\_LOAD\_ACK (Register 0x113, Bit 1) must be high to acknowledge that the frequency tuning word has updated.

The SEL\_SIDE BAND bit (Register 0x111, Bit 1 = 0b1) is a convenience bit that can be set to use the lower sideband modulation result, which is equivalent to flipping the sign of the frequency tuning word.

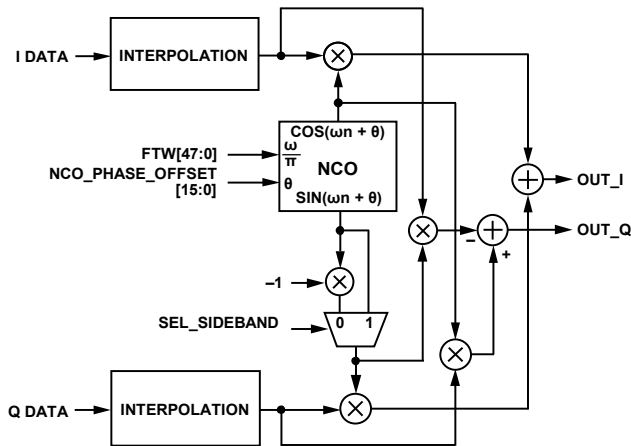

Figure 76. NCO Modulator Block Diagram

### Modulus NCO Mode (Direct Digital Synthesis (DDS))

The main 48-bit NCO can also be used in a dual-modulus mode to create fractional frequencies beyond the 48-bit accuracy. The modulus mode is enabled by programming the MODULUS\_EN bit in the DATAPATH\_CFG register to 1 (Register 0x111, Bit 2 = 0b1).

The frequency ratio for the programmable modulus DDS is very similar to that of the typical accumulator-based DDS. The only difference is that N is not required to be a power of two for the programmable modulus, but can be an arbitrary integer. In practice, hardware constraints place limits on the range of values for N. As a result, the modulus extends the use of the NCO to applications that require exact rational frequency synthesis. The underlying function of the programmable modulus technique is to alter the accumulator modulus.

Implementation of the programmable modulus function within the AD9166 is such that the fraction, M/N, is expressible using the following equation. Note that the form of the equation implies a compound FTW with X representing the integer part and A/B representing the fractional part.

$$\frac{f_{\text{CARRIER}}}{f_{\text{DAC}}} = \frac{M}{N} = \frac{X + \frac{A}{B}}{2^{48}}$$

where:

X is programmed in Register 0x114 to Register 0x119.

A is programmed in Register 0x12A to Register 0x12F.

B is programmed in Register 0x124 to Register 0x129.

### Programmable Modulus Example

Consider the case in which  $f_{\text{CLK}} = 2500$  MHz and the desired value of  $f_{\text{CARRIER}}$  is 250 MHz. This scenario synthesizes an output frequency that is not a power of two submultiple of the sample rate, namely  $f_{\text{CARRIER}} = (1/10) f_{\text{CLK}}$ , which is not possible with a typical accumulator-based DDS.

The frequency ratio,  $f_{\text{CARRIER}}/f_{\text{CLK}}$ , leads directly to M and N, which are determined by reducing the fraction (250,000,000/2,500,000,000) to its lowest terms, that is,

$$M/N = 250,000,000/2,500,000,000 = 1/10$$

Therefore, M = 1 and N = 10.

After calculation, X = 28,147,497,671,065, A = 3, and B = 5. Programming these values into the registers for X, A, and B (X is programmed in Register 0x114 to Register 0x119, B is programmed in Register 0x124 to Register 0x129, and A is programmed in Register 0x12A to Register 0x12F) causes the NCO to produce an output frequency of exactly 250 MHz given a 2500 MHz sampling clock. For more details, refer to the [AN-953 Application Note](#) on the Analog Devices, Inc., website.

### NCO Reset

Resetting the NCO can be useful when determining the start time and phase of the NCO. The NCO can be reset by several different methods, including a SPI write, using the TX\_ENABLE pin, or by the SYSREF± signal. Due to internal timing variations from device to device, these methods achieve an accuracy of  $\pm 6 f_{\text{CLK}}$  cycles.

Program Register 0x800, Bits[7:6] to 0b01 to set the NCO in phase discontinuous switching mode via a write to the SPI port. Then, any time the frequency tuning word is updated, the NCO phase accumulator resets and the NCO begins counting at the new frequency tuning word.

### Fast Frequency Hopping (FFH)

To support fast frequency hopping, the AD9166 has several features in the NCO block. There are two implementations of the NCO function. The main 48-bit NCO is a general-purpose NCO and supports some of the fast frequency hopping modes, whereas the fast frequency hopping NCO is specifically designed to support several different fast frequency hopping modes.

### Main NCO Frequency Hopping

In the main 48-bit NCO, the mode of updating the frequency tuning word can be changed from requiring a write to the FTW\_LOAD\_REQ bit (Register 0x113, Bit 0) to an automatic update mode. In the automatic update mode, the frequency tuning word is updated as soon as the chosen frequency tuning word is written.

To set the automatic frequency tuning word update mode, write the appropriate word to the FTW\_REQ\_MODE bits (Register 0x113, Bits[6:4]), choosing the particular frequency tuning word that causes the automatic update.

For example, if relatively coarse frequency steps are needed, it may be sufficient to write a single word to the MSB byte of the frequency tuning word, and therefore the FTW\_REQ\_MODE bits can be programmed to 110 (Register 0x113, Bits[6:4] = 0b110). Then, each time the most significant byte, FTW5, is written, the NCO frequency tuning word is automatically updated.

The FTW\_REQ\_MODE bits can be configured to use any frequency tuning word as the automatic update trigger word. This configuration provides convenience when choosing the order in which to program the FTW registers.

The speed of the SPI port write function is a minimum of 100 MHz (see Table 9). Thus, the NCO frequency tuning word can be updated in as little as 240 ns with a one-register write in automatic update mode.

### FFH NCO

The fast frequency hopping NCO is implemented as the main 48-bit NCO with an additional 31, 32-bit NCOs, with an associated bank of 31 frequency tuning words. These frequency tuning words can be preloaded into the hopping frequency register bank. Any of the 32 frequency tuning words can be selected by a one-register write to the HOPF\_SEL bits in the HOPF\_CTRL register (Register 0x800, Bits[4:0]). The manner in which the NCO transitions to the new frequency is determined by the hopping frequency change mode selection.

The fast frequency hopping NCO supports several modes for transitioning the phase of the NCO output as the output is hopped to a new frequency: phase continuous switching, phase discontinuous switching, and phase coherent switching. The NCO frequency change modes are listed in Table 37.

**Table 37. NCO Frequency Change Mode**

Register 0x800, Bits[7:6]	Description
0b00	Phase continuous switch
0b01	Phase discontinuous switch (reset NCO accumulator)
0b10	Phase coherent switch

In phase continuous switching, the frequency tuning word of the NCO is updated and the phase accumulator continues to accumulate to the new frequency.

In phase discontinuous mode, the frequency tuning word of the NCO is updated and the phase accumulator is reset, making an instantaneous jump to the new frequency.

In phase coherent mode, the bank of additional 31 phase accumulators is enabled, one each to shadow each FTW in the hopping frequency register bank.

Upon enabling the phase coherent switching mode (Register 0x800, Bits[7:6] = 0b10), all 32 NCO phase accumulators begin counting simultaneously, and all continue counting regardless of which individual NCO output is currently being used in the digital datapath. In this way, the frequency of an individual NCO can be chosen and is always phase coherent to Time 0. Therefore, it is recommended to preload all frequency tuning

words, then select the phase coherent switch mode to start them at the same time.

To conserve power, each of the 31 additional NCOs and phase accumulators is enabled only when a frequency tuning word is programmed into its register. To power down a particular NCO and phase accumulator, program all zeros to the FTW register for a given NCO. All NCO frequency tuning words have a default value of 0x0. The main 48-bit NCO, which is FTW0 in the fast frequency hopping NCO, is enabled by the NCO\_EN bit in the DATAPATH\_CFG register (Register 0x111, Bit 6 = 0b1).

To ensure that there is no residual power consumption or possible residual spurious from one of the 32-bit NCOs after powering it up and then powering it down, the suggested method to power down the additional NCO is to first program the frequency tuning word to 0x0001, and then program it to 0x0000. This procedure ensures that the phase accumulator is flushed of residual values prior to receiving the all 0s word, which powers down the output but not the accumulator. The accumulator is powered down with the NCO\_EN bit in Register 0x111, Bit 6.

### NCO Only Mode

The AD9166 is capable of operating in a mode with only the modulus NCO enabled, to function as a DDS, without a JESD204B link. In this mode, a single-tone sine wave is generated by the NCO, mixed with dc data samples to set the tone amplitude, and sent to the DAC output. Thus, NCO only mode is sometimes referred to as dc test mode. The dc data samples are generated internally, without the need for a functional JESD204B link to provide the data samples. All of the features described in the Digital Modulation section are available in the NCO only mode. It is not necessary to bring up the JESD204B link in this mode.

NCO only mode is a useful option, for example, to generate a sine wave for setting up a transmitter radio signal chain without the need for a digital data source from a JESD204B transmitter. The NCO only mode can also be used in applications where a sine wave is all that is needed, such as in a local oscillator (LO) application, as an LO to a mixing stage.

To enable the NCO only mode, program the DC\_TEST\_EN bit in Register 0x150, Bit 1 = 0b1. Then, program a dc value into the twos complement dc test data word in Register 0x14E (MSB) and Register 0x14F (LSB). The default value is 0x0000 (zero amplitude), and a typical value to program is 0x7FFF for a full-scale tone. The final step is to program the interpolation value to 1× bypass mode by selecting INTERP\_MODE = 0b0000 in Register 0x110, Bits[3:0]. This step is necessary because the dc test value is only available in the bypass path and is not accessible in the complex datapath.

When DC\_TEST\_EN = 1, the data source of the digital datapath is the dc test data word. This means that the JESD204B link can be brought up and data can be transferred to the device over the link, but the data is not presented to the DAC when DC\_TEST\_EN = 1. Connection to the SERDES data source is only achieved when

DC\_TEST\_EN = 0. The DC\_TEST\_EN bit can be toggled to switch the NCO input between SERDES data and dc data while the device is playing a signal (hot switching), but because switching to the SERDES datapath normally requires synchronizing a JESD204B link and/or setting the interpolation value, hot switching the DC\_TEST\_EN bit is not normally practical.

**INVERSE SINC**

The AD9166 provides a digital inverse sinc filter to compensate the DAC roll-off over frequency. The filter is enabled by setting the INVSINC\_EN bit (Register 0x111, Bit 7) and is disabled by default.

The inverse sinc ( $\text{sinc}^{-1}$ ) filter is a seven-tap FIR filter. Figure 77 shows the frequency response of  $\text{sin}(x)/x$  roll-off, the inverse sinc filter, and the composite response. The composite response has less than  $\pm 0.05$  dB pass-band ripple up to a frequency of  $0.4 \times f_{\text{CLK}}$ . When  $2 \times \text{NRZ}$  mode is enabled, the inverse sinc filter operates to  $0.4 \times 2 \times f_{\text{CLK}}$ .

To provide the necessary peaking at the upper end of the pass band without the risk of clipping, the inverse sinc filter has an intrinsic insertion loss of about 3.8 dB (shown in Figure 77).

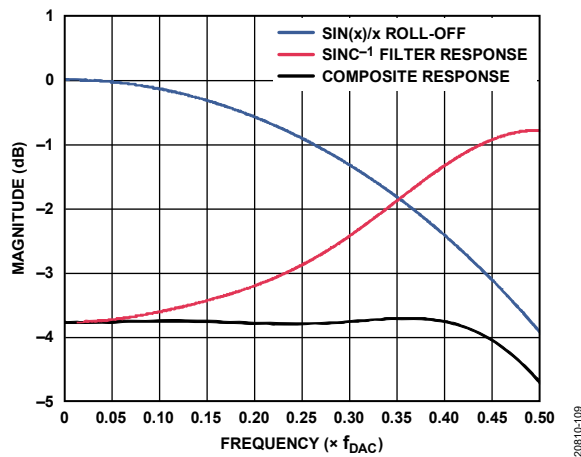

Figure 77. Responses of  $\text{Sin}(x)/x$  Roll-Off, the  $\text{Sinc}^{-1}$  Filter, and the Composite of the Two

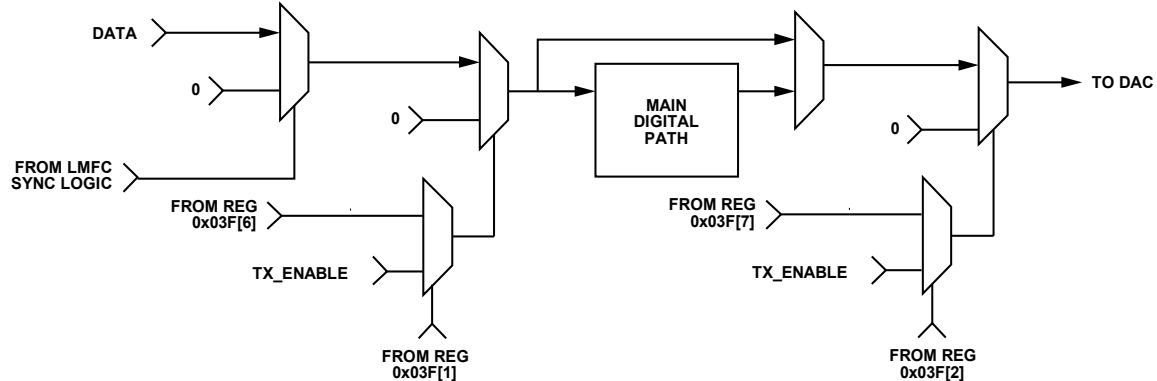

Figure 78. Downstream Protection Block Diagram

**DOWNSTREAM PROTECTION**

The AD9166 has several features designed to protect the power amplifier of the system, as well as other downstream blocks. These features consist of a control signal from the LMFC sync logic and a transmit enable function. The protection mechanism in each case is the blanking of data that is passed to the DAC decoder. The differences lie in the location in the datapath and slight variations of functionality.

The JESD204B serial link has several flags and quality measures to indicate the serial link is active and running error free. If any of these measures flags an issue, a signal from the LMFC sync logic is sent to a mux that stops data from flowing to the DAC decoder and replaces it with 0s.

There are several transmit enable features, including a TX\_ENABLE register that can be used to squelch data at several points in the datapath or configure the TX\_ENABLE pin to do likewise.

**Transmit Enable**

The transmit enable feature can be configured either as a SPI controlled function or a pin controlled function, and can be used for several different purposes. The SPI controlled function has less accurate timing due to its reliance on a microcontroller to program it. Therefore, it is typically used as a preventative measure at power-up or when configuring the device.

The SPI controlled TX\_ENABLE function can be used to zero the input to the digital datapath or to zero the output from the digital datapath, as shown in Figure 78. If the input to the digital datapath is zeroed, any filtering that is selected filters the 0 signal, causing a gradual ramp-down of energy in the digital datapath. If the digital datapath is bypassed, as in  $1 \times$  interpolation mode, the data at the input to the DAC immediately drops to zero.

The TX\_ENABLE pin can be used for more accurate timing when enabling or disabling the DAC output. The effect of the TX\_ENABLE pin can be configured by the TX\_ENABLE register (Register 0x03F) as is used for the SPI controlled functions, and the pin can be configured to have the same effects as the SPI controlled function, namely to zero the input to the digital datapath or to zero the output from the digital datapath. In addition, the TX\_ENABLE pin can also be configured to ramp down (or up) the full-scale current of the DAC. The ramp down reduces the output power of the DAC by about 20 dB from full scale to the minimum output current.

The TX\_ENABLE pin can also be programmed to reset the NCO phase accumulator. See Table 38 for a description of the settings available for the TX\_ENABLE register function.

**Table 38. TX\_ENABLE Settings**

Register 0x03F	Setting	Description
Bit 7	0	SPI control: zero data to the DAC
	1	SPI control: allow data to pass to the DAC
Bit 6	0	SPI control: zero data at input to the datapath
	1	SPI control: allow data to enter the datapath
Bits[5:4]	N/A <sup>1</sup>	Reserved
Bit 3	0	Use SPI writes to reset the NCO <sup>2</sup>
	1	Use TX_ENABLE to reset the NCO
Bit 2	0	Use SPI control to zero data to the DAC
	1	Use TX_ENABLE pin to zero data to the DAC
Bit 1	0	Use SPI control to zero data at the input to the datapath
	1	Use TX_ENABLE pin to zero data at input to the datapath
Bit 0	0	Use SPI registers to control the full-scale current
	1	Use TX_ENABLE pin to control the full-scale current

<sup>1</sup> N/A means not applicable.

<sup>2</sup> Use SPI writes to reset the NCO if resetting the NCO is desired. Register 0x800, Bits[7:6] determine whether the NCO is reset. See Table 37 for more details.

## DATAPATH PRBS

The datapath PRBS can verify the AD9166 datapath receives and correctly decodes data. The datapath PRBS verifies the JESD204B parameters of the transmitter and receiver match, the lanes of the receiver are mapped appropriately, the lanes are appropriately inverted, and, if necessary, the start-up routine is correctly implemented.

To run the datapath PRBS test, complete the following steps:

1. Set up the device in the desired operating mode using the start-up sequence.
2. Send PRBS7 or PRBS15 data.
3. Write Register 0x14B. Bit 2 = 0 for PRBS7 or Bit 2 = 1 for PRBS15.
4. Write Register 0x14B, Bits[1:0] = 0b11 to enable and reset the PRBS test.
5. Write Register 0x14B, Bits[1:0] = 0b01 to enable the PRBS test and release reset.
6. Wait 500 ms.
7. Check the status of the PRBS by checking the IRQ for the I and Q path PRBS as described in the Datapath PRBS IRQ section.
8. Read Register 0x14B, Bits[7:6]. Bit 6 is 0 if the I channel has any errors. Bit 7 is 0 if the Q channel has any errors.
9. Read Register 0x14C to read the error count for the I channel.
10. Read Register 0x14D to read the error count for the Q channel. The PRBS processes 32 bits at a time, and compares the 32 new bits to the previous set of 32 bits. The PRBS detects and reports only one error in every group of 32 bits. Therefore, the error count partly depends on when the errors are seen.

For example, see the following sequences:

- Bits: 32 good; 31 good, 1 bad; 32 good (one error)
- Bits: 32 good; 22 good, 10 bad; 32 good (one error)
- Bits: 32 good; 31 good, 1 bad; 31 good, 1 bad; 32 good (two errors)

## DATAPATH PRBS IRQ

The PRBS fail signals for the I and Q path are available as IRQ events. Use Register 0x020, Bits[1:0] to enable the fail signals, and then use Register 0x024, Bits[1:0] to read back the status and reset the IRQ signals. See the Interrupt Request Operation section for more information.



## INTERRUPT REQUEST OPERATION

The AD9166 provides an interrupt request output signal ( $\overline{\text{IRQ}}$ ) on Ball L5 that can be used to notify an external host processor of significant device events. On assertion of the interrupt, query the device to determine the precise event that occurred. The  $\overline{\text{IRQ}}$  pin is an open-drain, active low output. Pull the  $\overline{\text{IRQ}}$  pin high, external to the device. The  $\overline{\text{IRQ}}$  pin can be tied to the interrupt pins of other devices with open-drain outputs to wire-OR these pins together.

Figure 79 shows a simplified block diagram of how the IRQ blocks work. When the  $\overline{\text{IRQ\_EN}}$  signal is low, the  $\overline{\text{INTERRUPT\_SOURCE}}$  signal is set to 0. When  $\overline{\text{IRQ\_EN}}$  is high, any rising edge of the event signal causes the  $\overline{\text{INTERRUPT\_SOURCE}}$  signal to be set high. If any  $\overline{\text{INTERRUPT\_SOURCE}}$  signal is high, the  $\overline{\text{IRQ}}$  pin is pulled low.  $\overline{\text{INTERRUPT\_SOURCE}}$  can be reset to 0 by either an  $\overline{\text{IRQ\_RESET}}$  signal or a  $\overline{\text{DEVICE\_RESET}}$  signal.

Depending on the  $\overline{\text{STATUS\_MODE}}$  signal, the  $\overline{\text{EVENT\_STATUS}}$  bit reads back an event signal or  $\overline{\text{INTERRUPT\_SOURCE}}$  signal. The AD9166 has several interrupt register blocks (IRQ) that can monitor up to 75 events (depending on device configuration). Certain details vary by IRQ register block as described in Table 39. Table 40 shows the source registers of the  $\overline{\text{IRQ\_EN}}$ ,  $\overline{\text{IRQ\_RESET}}$ , and  $\overline{\text{STATUS\_MODE}}$  signals in Figure 79, as well as the address where  $\overline{\text{EVENT\_STATUS}}$  is read back.

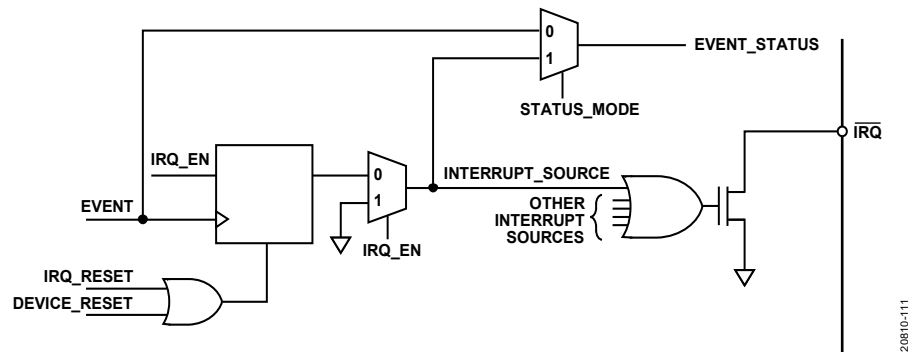

Figure 79. Simplified Schematic of  $\overline{\text{IRQ}}$  Circuitry

Table 40. IRQ Register Block Address of IRQ Signal Details

Register Block	Address of IRQ Signals <sup>1</sup>			
	$\overline{\text{IRQ\_EN}}$	$\overline{\text{IRQ\_RESET}}$	$\overline{\text{STATUS\_MODE}}$ <sup>2</sup>	$\overline{\text{EVENT\_STATUS}}$
0x020, 0x024	0x020; R/W per chip	0x024; W per chip	$\overline{\text{STATUS\_MODE}} = \overline{\text{IRQ\_EN}}$	0x024; R per chip
0x4B8 to 0x4BB	0x4B8, 0x4B9; W per error type	0x4BA, 0x4BB; W per error type	N/A, $\overline{\text{STATUS\_MODE}} = 1$	0x4BA, 0x4BB; R per chip
0x470 to 0x473	0x470 to 0x473; W per error type	0x470 to 0x473; W per link	N/A, $\overline{\text{STATUS\_MODE}} = 1$	0x470 to 0x473; R per link

<sup>1</sup> R is read; W is write; and R/W is read/write.

<sup>2</sup> N/A means not applicable.

Table 39. IRQ Register Block Details

Register Block	Event Reported	$\overline{\text{EVENT\_STATUS}}$
0x020, 0x024	Per chip	$\overline{\text{INTERRUPT\_SOURCE}}$ when $\overline{\text{IRQ}}$ is enabled; when $\overline{\text{IRQ}}$ is disabled, $\overline{\text{IRQ}}$ is the event signal
0x4B8 to 0x4BB; 0x470 to 0x473	Per link and lane	$\overline{\text{INTERRUPT\_SOURCE}}$ when $\overline{\text{IRQ}}$ is enabled; when $\overline{\text{IRQ}}$ is disabled, 0

## INTERRUPT SERVICE ROUTINE

Interrupt request management starts by selecting the set of event flags that require host intervention or monitoring. Enable the events that require host action so that the host is notified when such events occur. For events requiring host intervention upon  $\overline{\text{IRQ}}$  activation, run the following routine to clear an interrupt request:

1. Read the status of the event flag bits that are being monitored.
2. Disable the interrupt by writing 0 to  $\overline{\text{IRQ\_EN}}$ .
3. Read the event source.
4. Perform any actions that may be required to clear the cause of the event. In many cases, no specific actions may be required.
5. Verify that the event source is functioning as expected.
6. Clear the interrupt by writing 1 to the  $\overline{\text{IRQ\_RESET}}$  signal.
7. Enable the interrupt by writing 1 to the  $\overline{\text{IRQ\_EN}}$  signal.

## APPLICATIONS INFORMATION

### HARDWARE CONSIDERATIONS

#### Power Supply Recommendations

All AD9166 supply domains must remain as noise free as possible for optimal operation. Power supply noise carries frequency content that may adversely affect performance, and it may appear in the output spectrum of the device.

An inductor/capacitor (LC) filter on the output of the power supply is recommended to attenuate the noise, and must be placed as close to the AD9166 as possible.

The DAC\_1P2\_CLK supply is the most noise sensitive supply on the device, where phase noise and other spectral content are modulated directly onto the output signal. Other analog supplies are sensitive as well. DAC\_2P5\_AN and DAC\_N1P2\_AN are the DAC output rails and modulate noise onto the DAC output and into the amplifier input. AMP\_5V\_IN, AMP\_3P3\_OUT, and AMP\_N5 are the analog rails for the amplifier input and output and may similarly modulate noise onto the output.

It is highly recommended that DAC\_1P2\_CLK be supplied by itself with an ultralow noise regulator such as the [ADM7154](#) or [ADP1761](#), with high power supply rejection ratio (PSRR) specifications to filter any unwanted switching supply noise, and achieve optimal phase noise performance.

Noisier regulators impose phase noise onto the DAC output, the amplifier input and output, and ultimately onto the output signal at the RFOUT pin.

The DAC\_1P2\_AN supply can be connected to the digital DAC\_1P2\_DIG supply with a separate filter network.

Connect DAC\_1P2\_SER, the 1.2V supply for the JESD204B circuitry, to a separate regulator.

The AMP\_3P3 supply can be connected to the AMP\_3P3\_OUT RF output supply with a separate filter network.

The VDD\_IO supply can be connected to either the AMP\_3P3 or the AMP\_3P3\_OUT supply with a separate filter network. VDD\_IO can also be powered separately from a system controller (for example, a microcontroller), 1.8 V to 3.3 V supply. The power supply sequencing requirement must be met, where AMP\_3P3 must come up with or before VDD\_IO.

Take note of the maximum power consumption numbers given in Table 2 to ensure the power supply design can tolerate temperature and IC process variation extremes. The amount of current drawn is dependent on the chosen use cases. Specifications are provided for several use cases to illustrate examples and contributions from individual blocks, and to assist in calculating the maximum required current per supply.

Another consideration for the power supply design is peak current handling capability. The AD9166 draws more current in the main digital supply (DAC\_1P2\_DIG) when synthesizing a signal with significant amplitude variations, such as a modulated signal with high peak to average power ratio (PAPR)

or burst signals such as global system for mobile communications (GSM), time division multiple access (TDMA), or other signals that have an on and off time domain response. Therefore, the power supply must be able to supply current quickly to accommodate burst signals. Because the amount of current variation depends on the signals used, it is recommended to perform lab testing first to establish ranges. A typical variation can be several hundred milliamperes over a short time period, requiring more than 220  $\mu\text{F}$  of bulk capacitance with low ESR.

#### Power Sequencing

The AD9166 requires power sequencing to avoid damage to internal circuitry. A board design with the AD9166 must include a power sequencer chip, such as the [LTC2928](#), to ensure that the domains power up in the correct order. To minimize current transients during startup, separate high power, noncritical power domains across the sequence.

Perform the power-up sequence in the following order, and ensure that the supplies in each group power up and settle together:

1. DAC\_1P2\_DIG, AMP\_3P3, AMP\_3P3\_OUT, VDD\_IO, DAC\_3P3\_SYNC, AMP\_N5, DAC\_1P2\_AN, DAC\_1P2\_CLK
2. DAC\_N1P2\_AN, DAC\_1P2\_SER
3. AMP\_5V\_IN, DAC\_2P5\_AN (can be derived from AMP\_5V\_IN)

Within each group, monitor the supply with the longest settling time to ensure that all the supplies settle to their target voltage before sequencing to the next group.

There are no requirements for a power-down sequence.

#### Power and Ground Planes

Solid ground planes are recommended to avoid ground loops and to provide a solid, uninterrupted ground reference for the high speed transmission lines that require controlled impedances. For high frequency filtering, stack power planes between ground layers. Stacking also adds extra filtering and isolation between power supply domains (in addition to the decoupling capacitors).

Do not use segmented power planes as a reference for controlled impedances unless the entire length of the controlled impedance trace traverses across only a single segmented plane. These and additional guidelines for the topology of high speed transmission lines are described in the JESD204B Serial Interface Inputs (SERDIN0 $\pm$  to SERDIN7 $\pm$ ) section.

For some applications, where highest performance and higher output frequencies are required, the choice of PCB materials significantly impacts results. For example, materials such as polyimide or materials from the Rogers Corporation can be used to improve tolerance to high temperatures and improve performance. Materials from Rogers such as the RO43xx series, or from Isola, such as Tachyon, are typically used for the top

layer, and possibly for the bottom. Three layers are used in some board designs to allow the top layer to reference one of two planes: one for differential traces and one for single-ended traces. In this method, the trace widths are kept well within the manufacturing tolerances of PCB vendors. However, this may not be practical in some designs.

### JESD204B Serial Interface Inputs (SERDIN0± to SERDIN7±)

When considering the layout of the JESD204B serial interface transmission lines, there are many factors to consider to maintain optimal link performance. Among these factors are insertion loss, return loss, signal skew, and the topology of the differential traces.

#### Insertion Loss

The JESD204B specification limits the amount of insertion loss allowed in the transmission channel (see Figure 51). The AD9166 equalization circuitry allows significantly more loss in the channel than is required by the JESD204B specification. It is still important that the designer of the PCB minimize the amount of insertion loss by adhering to the following guidelines:

- Keep the differential traces short by placing the AD9166 as near to the transmitting logic device as possible and routing the trace as directly as possible between the devices.
- Route the differential pairs on a single plane using a solid ground plane as a reference. To avoid vias being used in the SERDES lanes, route the SERDES lanes on the same layer as the AD9166.
- Use a PCB material with a low dielectric constant ( $<4$ ) to minimize loss, if possible.

When choosing between the stripline and microstrip techniques, keep in mind the following considerations: stripline has less loss (see Figure 52 and Figure 53) and emits less EMI, but requires the use of vias that can add complexity to the task of controlling the impedance. Microstrip is easier to implement (if the component placement and density allow routing on the top layer) and eases the task of controlling the impedance.

If using the top layer of the PCB is problematic or the advantages of stripline are desirable, follow these recommendations:

- Minimize the number of vias.
- If possible, use blind vias to eliminate via stub effects and use microvias to minimize via inductance.
- If using standard vias, use the maximum via length to minimize the stub size. For example, on an 8-layer board, use Layer 7 for the stripline pair (see Figure 80).
- For each via pair, place a pair of ground vias adjacent to them to minimize the impedance discontinuity (see Figure 80).

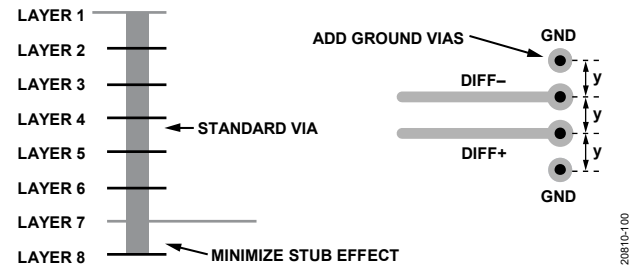

Figure 80. Minimizing Stub Effect and Adding Ground Vias for Differential Stripline Traces

#### Return Loss

The JESD204B specification limits the amount of return loss allowed in a converter device and a logic device, but does not specify return loss for the channel. However, every effort must be made to maintain a continuous impedance on the transmission line between the transmitting logic device and the AD9166. Minimizing the use of vias or eliminating vias reduces one of the primary sources for impedance mismatches on a transmission line (see the Insertion Loss section). Maintain a solid reference beneath (for microstrip) or above and below (for stripline) the differential traces to ensure continuity in the impedance of the transmission line. If the stripline technique is used, follow the guidelines listed in the Insertion Loss section to minimize impedance mismatches and stub effects.

Another primary source for impedance mismatch is at either end of the transmission line, where care must be taken to match the impedance of the termination to that of the transmission line. The AD9166 handles this internally with a calibrated termination scheme for the receiving end of the line. See the Interface Power-Up and Input Termination section for details on this circuit and the calibration routine.

#### Signal Skew

There are many sources for signal skew, but the two sources to consider when laying out a PCB are interconnect skew within a single JESD204B link and skew between multiple JESD204B links. In each case, keeping the channel lengths matched to within 12.5 mm is adequate for operating the JESD204B link at speeds of up to 12.5 Gbps. This amount of channel length match is equivalent to about 85% UI on the AD9166 evaluation board.

Managing the interconnect skew within a single link is fairly straightforward. Managing multiple links across multiple devices is more complex. However, follow the 12.5 mm guideline for length matching. The AD9166 can handle more skew than the 85% UI due to the six-PCLK cycle buffer in the JESD204B receiver, but matching the channel lengths as close as possible is still recommended.

**Topology**

Structure the differential SERDINx± pairs to achieve 50 Ω to ground for each half of the pair. Stripline vs. microstrip trade-offs are described in the Insertion Loss section. In either case, it is important to keep these transmission lines separated from potential noise sources, such as high speed digital signals and noisy supplies.

If using stripline differential traces, route them using a coplanar method, with both traces on the same layer. Although this method does not offer more noise immunity than the broadside routing method (traces routed on adjacent layers), it is easier to route and manufacture so that the impedance continuity is maintained. An illustration of broadside vs. coplanar is shown in Figure 81.

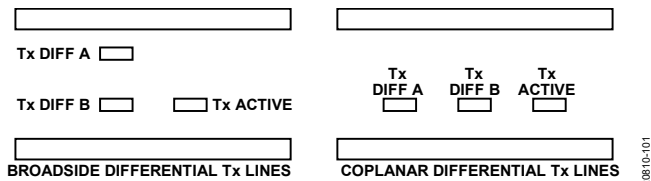

Figure 81. Broadside vs. Coplanar Differential Stripline Routing Techniques

When considering the trace width vs. copper weight and thickness, the speed of the interface must be considered. At multigigabit speeds, the skin effect of the conducting material confines the current flow to the surface. To reduce losses, maximize the surface area of the conductor by making the trace width wider. Additionally, loosely couple differential traces to accommodate the wider trace widths. This coupling helps reduce the crosstalk and minimize the impedance mismatch when the traces must separate to accommodate components, vias, connectors, or other routing obstacles. Tightly coupled vs. loosely coupled differential traces are shown in Figure 82.

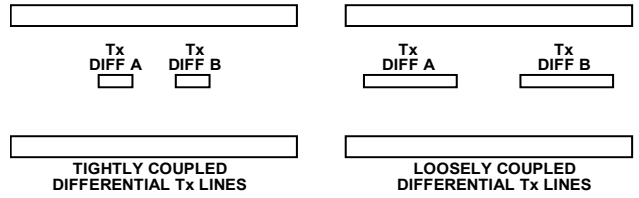

Figure 82. Tightly Coupled vs. Loosely Coupled Differential Traces

**AC Coupling Capacitors**

The AD9166 requires that the JESD204B input signals be ac-coupled to the source. These capacitors must be 100 nF and placed as close as possible to the transmitting logic device. To minimize the impedance mismatch at the pads, select the package size of the capacitor so that the pad size on the PCB matches the trace width as closely as possible.

**SYNCOUT±, SYSREF±, and CLK± Signals**

The SYNCOUT± and SYSREF± signals on the AD9166 are low speed LVDS differential signals. Use controlled impedance traces routed with 100 Ω differential impedance and 50 Ω to ground when routing these signals. As with the SERDIN0± to SERDIN7± data pairs, it is important to keep these signals separated from potential noise sources, such as high speed digital signals and noisy supplies.

Separate the SYNCOUT± signal from other noisy signals, because noise on the SYNCOUT± may be interpreted as a request for /K/ characters.

It is important to keep similar trace lengths for the CLK± and SYSREF± signals from the clock source to each of the devices on either end of the JESD204B links (see Figure 83). If using a clock chip that can tightly control the phase of CLK± and SYSREF±, the trace length matching requirements are greatly reduced.

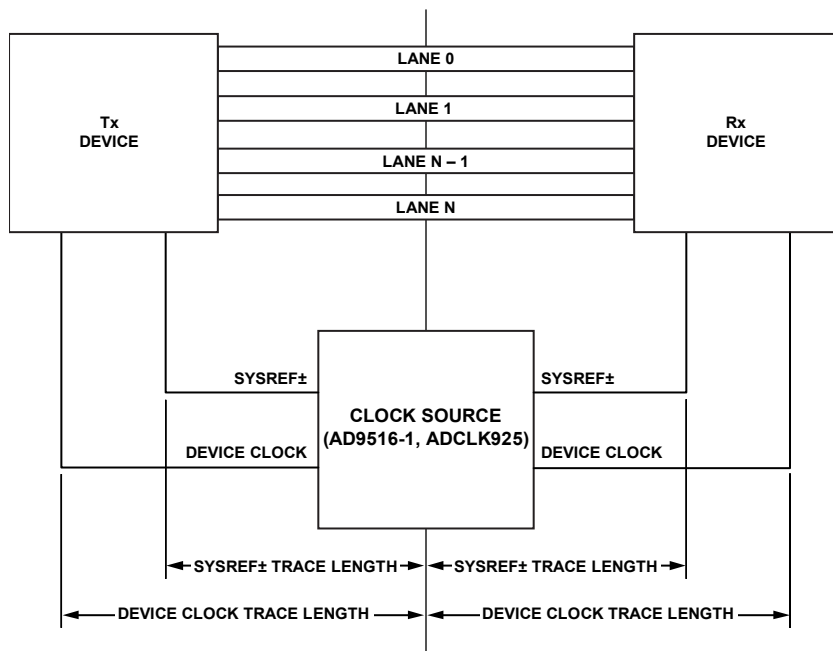
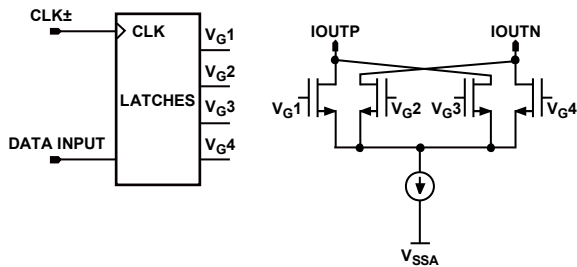

Figure 83. SYSREF± Signal and Device Clock Trace Length

# ANALOG INTERFACE CONSIDERATIONS

## ANALOG MODES OF OPERATION

The AD9166 DAC core uses the quad-switch architecture shown in Figure 84. Only one pair of switches is enabled during a half-clock cycle, thus requiring each pair to be clocked on alternative clock edges. A key benefit of the quad-switch architecture is that it masks the code dependent glitches that occur in the conventional two-switch DAC architecture.



**NOTES**  
 IOUTP AND IOUTN ARE THE POSITIVE AND NEGATIVE OUTPUT CURRENTS,  $V_{Gx}$  IS THE GATE VOLTAGE, AND  $V_{SSA}$  IS THE ANALOG SUPPLY VOLTAGE.

Figure 84. Quad-Switch Architecture

In dual-switch architecture, when a switch transition occurs and Data 1 and Data 2 ( $D_1$  and  $D_2$  in Figure 85) are in different states, a glitch occurs. However, if  $D_1$  and  $D_2$  happen to be at the same state, the switch transitions and no glitches occur. This code dependent glitching causes an increased amount of distortion in the DAC core. In quad-switch architecture (no matter what the codes are), there are always two switches that are transitioning at each half-clock cycle, thus eliminating the code dependent glitches but creating a constant glitch at  $2 \times f_{DAC}$  in the process. For this reason, a significant clock spur at  $2 \times f_{DAC}$  is evident in the output spectrum of the core.

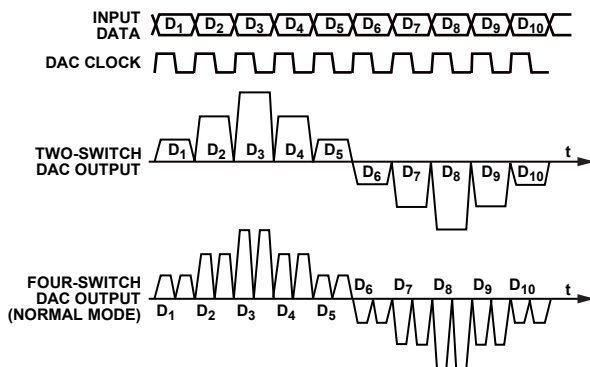

Figure 85. Two-Switch and Quad-Switch DAC Waveforms

As a consequence of the quad-switch architecture enabling updates on each half-clock cycle, it is possible to operate the DAC core at  $2 \times$  the expected DAC update rate ( $f_s$ ) if new data samples are latched into the DAC core on both the rising and falling edge of the device clock ( $f_{CLK}$ ). This notion serves as the basis when operating the AD9166 in mix mode, RZ mode, or  $2 \times$  NRZ mode. In each case, the DAC core is presented with new data samples on each clock edge. In RZ mode, the rising edge clocks data and the falling edge clocks zero. In mix mode, the falling edge sample is

simply the complement of the rising edge sample value. In  $2 \times$  NRZ mode, both the rising edge and falling edge clock new data samples. See the  $2 \times$  NRZ Mode section for more details.

When mix mode is used, the output is effectively chopped at the DAC sample rate. This chopping has the effect of reducing the power of the fundamental signal while increasing the power of the images centered around the DAC sample rate, thus improving the dynamic range of these images.

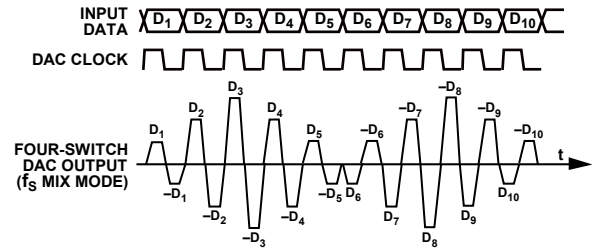

Figure 86. Mix Mode Waveform

This ability to change modes provides the user the flexibility to place a carrier anywhere in the first three Nyquist zones, depending on the operating mode selected. Switching between baseband and mix mode reshapes the sinc roll-off inherent at the DAC output. In baseband mode, the sinc null appears at  $f_s$  because the same sample latched on the rising clock edge is also latched again on the falling clock edge, thus resulting in the same ubiquitous sinc response of a traditional DAC. In mix mode, the complement sample of the rising edge is latched on the falling edge, therefore pushing the sinc null to  $2 \times f_s$ . Figure 87 shows the ideal frequency response of the three modes with the sinc roll-off included.

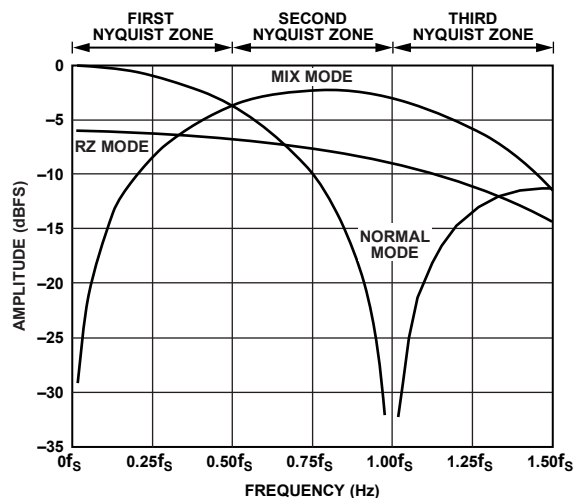

Figure 87. Sinc Roll-Off for NRZ, RZ, and Mix Mode Operation

The quad-switch can be configured via SPI (Register 0x152, Bits[1:0]) to operate in either NRZ mode (0b00), RZ mode (0b10), or mix mode (0b01).

**2× NRZ Mode**

The AD9166 has an additional mode that allows doubling the DAC sample rate. The 2× NRZ mode is implemented using the FIR85 2× interpolation filter, which provides new samples to the DAC core on both rising and falling edges of the device clock. As a result, the analog bandwidth in 2× NRZ mode also doubles in comparison to NRZ mode, as illustrated in Figure 88.

Because the DAC sample rate ( $f_{DAC}$ ) is now twice the device clock ( $f_{CLK}$ ), the energy in the image frequency at  $f_{CLK} - f_{OUT}$  appears at  $2 \times f_{CLK} - f_{OUT}$ . Assuming the differential device clock has perfect phase and amplitude balance, the image at  $f_{CLK} - f_{OUT}$  can be eliminated altogether. Phase imbalance can be compensated in the device clock receiver of the AD9166. See the Clock Input section for more details.

Because the FIR85 interpolator is sampling at a higher rate, it also consumes more power when compared to a similar NRZ mode, RZ mode, or mix mode.

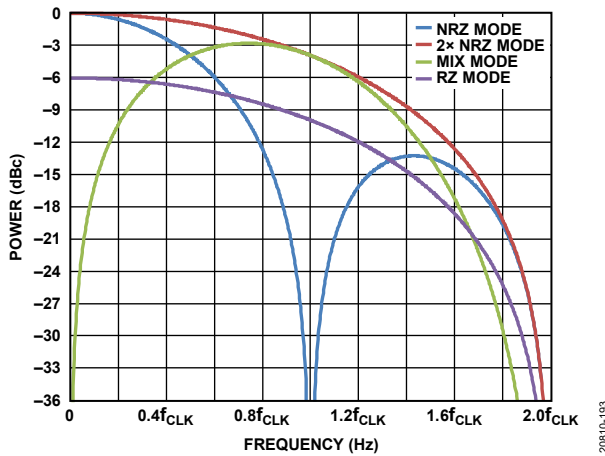

Figure 88. Sinc Roll-Off for 2× NRZ, NRZ, RZ, and Mix Mode Operation

**CLOCK INPUT**

The AD9166 contains a low jitter, differential clock receiver that is capable of interfacing directly to a differential or single-ended clock source. Because the input is self biased with a nominal impedance of 90 Ω, it is recommended that the clock source be ac-coupled to the CLK± input pins. The nominal differential input is 1 V p-p, but the clock receiver can operate with a span that ranges from 250 mV p-p to 2.0 V p-p.

Higher clock input level results in improved phase noise (phase jitter) performance, because the higher swing results in a higher slew rate (faster rise time).

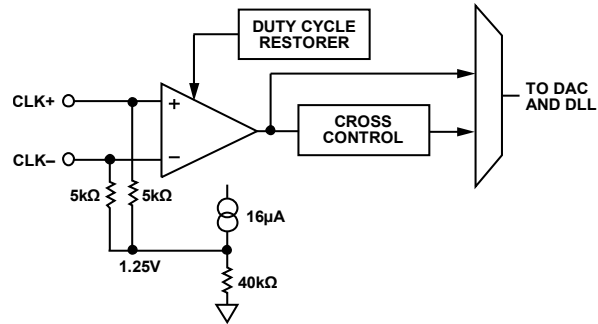

Figure 89. Clock Input

The quality of the clock source, as well as its interface to the AD9166 clock input, directly impacts ac performance. Select the phase noise and spur characteristics of the clock source to meet the target application requirements. Phase noise and spurs at a given frequency offset on the clock source are directly translated to the output signal. Specifically, it can be shown that the phase noise characteristics of a reconstructed output sine wave are related to the clock source by  $20 \times \log_{10}(f_{OUT}/f_{DAC})$  when the internal device clock path contribution is negligible.

Figure 90 shows a clock source based on the ADF4372 low phase noise/jitter PLL. The ADF4372 can provide output frequencies from 62.5 MHz up to 16,000 MHz using the RF16x port and up to 8,000 MHz using the RF8x or RFAUX8x ports.

**Adjusting Clock Duty-Cycle and Differential Phase Imbalance**

The clock control registers exist at Register 0x082 through Register 0x084. CLK\_DUTY (Register 0x082) can be used to enable duty cycle correction (Bit 7), enable duty cycle offset control (Bit 6), and set the duty cycle offset (Bits[4:0]). The duty cycle offset word is a signed magnitude word, with Bit 4 as the sign bit (1 is negative) and Bits[3:0] as the magnitude. The duty cycle adjusts across a range of approximately ±3%. Recommended settings for this register are listed in the Start-Up Sequence section.

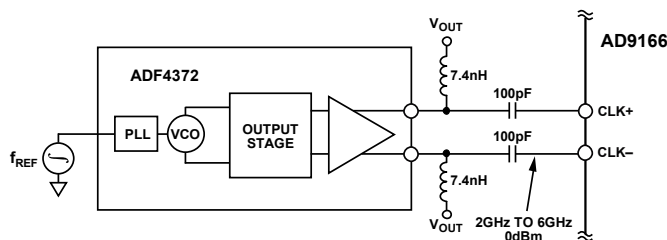

Figure 90. Possible Signal Chain for CLK± Input

The clock receiver can compensate for phase imbalance of the CLK+ and CLK- inputs (CLK\_PHASE\_TUNE register at Address 0x07F). The register value is a signed binary, with the MSB acting as the sign bit. Each additional step increase adds 20 fF of capacitance to either the CLK+ or the CLK- input. See Table 41 for more details. Compensating for phase imbalance improves the image rejection of the DAC.

Table 41. CLK± Phase Adjust Values

Register 0x07F, Bits[5:0]	Capacitance at CLK+ (fF)	Capacitance at CLK- (fF)
000000	0	0
000001	1 × 20	0
000010	2 × 20	0
...	...	...
011111	31 × 20	0
100000	0	0
100001	0	1 × 20
100010	0	2 × 20
...	...	...
111111	0	31 × 20

The improvement in performance depends on the phase balance of the external components as well as on the internal clock path. Process variations may result in varying phase balance across devices of the same population. Thus, if higher levels of image rejection are desired, it may be beneficial to calibrate each device independently, installed in the target system. Performing this calibration has shown significant improvements in some cases, in particular when less expensive baluns are used.

Figure 91 shows how adjusting the clock phase, duty cycle, and cross control can help compensate for phase and amplitude imbalance at the CLK± pins.

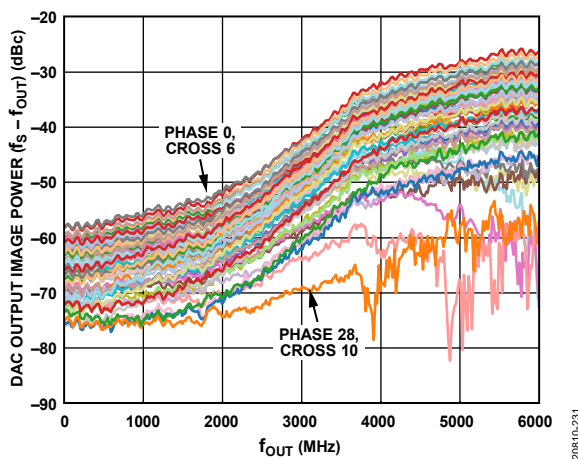

Figure 91. Performance Improvement from Tuning the Clock Input

### Delay Locked Loop (DLL)

The CLK± input goes to a high frequency DLL to ensure reliable locking of the internal DAC sample clock to the input clock. The DLL is configured and enabled as part of the recommended start-up sequence. The DLL control registers are located at Register 0x090 through Register 0x09B. The DLL settings are determined during product characterization and are given in the recommended start-up sequence (see the Start-Up Sequence section). It is not normally necessary to change these values, and the product characterization data is valid only with the recommended settings.

### SHUFFLE MODE

The spurious performance of the AD9166 can be improved with a feature called shuffle mode. Shuffle mode uses proprietary technology to spread the energy of spurious signals across the DAC output as random noise. Shuffle mode is enabled by programming Register 0x151, Bit 2 = 0b1. Because shuffle mode is implemented using the MSB current sources of the DAC, it is most effective when the DAC is operated with a small amount of digital backoff relative to 0 dBFS.

The amount of noise rise at the output of the DAC core caused by shuffle mode is directly related to the power in the affected spurious signals. Because the AD9166 has a wideband buffer amplifier at the output of the DAC core, the increase in noise spectral density is not apparent with or without shuffle.

Shuffle mode improves the spurious performance related to clock and foldback spurs, but does not affect real harmonics generated at the DAC output.

### VOLTAGE REFERENCE AND FULL-SCALE CURRENT (FSC)

The full-scale current at the DAC output, IOUTFS, controls the maximum output current swing out of the DAC and into the input of the buffer amplifier. When adjusting IOUTFS, the input common-mode current of the buffer amplifier, ICM, must be adjusted to match the IOUTFS value of the DAC.

ICM is set using the digital control bits (AMP\_ICM, Amplifier Register 0x18), and it must be set to the nearest corresponding value that matches IOUTFS. For more details, see the Adjusting ICM to Match IOUTFS section.

IOUTFS is set through a combination of digital control bits and the reference current, ISET, as shown in Figure 92.

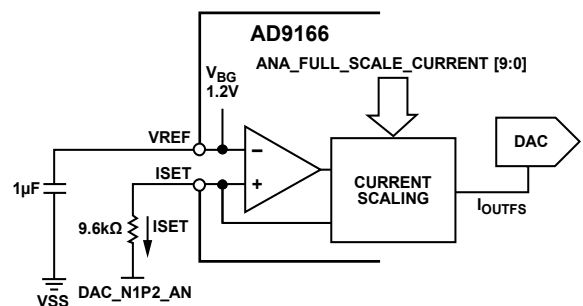

Figure 92. Voltage Reference Circuit

$I_{SET}$  is obtained by forcing the band gap voltage of the DAC across an external 9.76 k $\Omega$   $R_{SET}$  resistor from the ISET pin to DAC\_N1P2\_AN. The 1.2 V nominal band gap voltage ( $V_{BG}$  at VREF) results in a 125  $\mu$ A reference current,  $I_{SET}$ , through the 9.76 k $\Omega$  resistor.  $I_{SET}$  is then internally amplified to set the maximum  $I_{OUTFS}$  value,  $I_{OUTFS\_MAX}$ , which can be controlled digitally. Although  $R_{SET}$  can be adjusted to a higher value to limit  $I_{OUTFS\_MAX}$ , the suggested value is 9.76 k $\Omega$ . Further adjustments to  $I_{OUTFS}$  must be performed digitally.

The  $I_{OUTFS\_MAX}$  setting is related to the external resistor by the following equation:

$$I_{OUTFS\_MAX} = 1.2 \text{ V} / R_{SET} \times 320$$

where:

1.2 V is the nominal band gap voltage.

$R_{SET}$  is the external resistor value in k $\Omega$ .

320 is a gain constant.

Note that the following constraints apply when configuring the voltage reference circuit:

- Both the 9.76 k $\Omega$  resistor and 1  $\mu$ F bypass capacitor are required for proper operation.
- Adjusting the DAC output full-scale current,  $I_{OUTFS}$ , from its default setting of 40 mA must be performed digitally.
- The AD9166 is not a multiplying DAC. Modulation of the reference current,  $I_{SET}$ , with an ac signal is not supported.
- The band gap voltage appearing at the VREF pin must be buffered for use with external circuitry because it has a high output impedance.
- An external reference can be used to overdrive the internal reference by connecting it to the VREF pin.

The  $I_{OUTFS}$  value can be adjusted digitally over an 8 mA to 40 mA range by ANA\_FULL\_SCALE\_CURRENT, Bits[9:0] (Register 0x042, Bits[7:0]) and Register 0x041, Bits[1:0]). The following equation relates  $I_{OUTFS}$  to the ANA\_FULL\_SCALE\_CURRENT bits, which can be set from 0 to 1023:

$$I_{OUTFS} = 32 \text{ mA} \times (ANA\_FULL\_SCALE\_CURRENT / 1023) + 8 \text{ mA}$$

Note that the default value of 0x3FF generates 40 mA full scale, and this value is used for most of the characterization presented in this data sheet, unless noted otherwise.

### Adjusting $I_{CM}$ to Match $I_{OUTFS}$

When adjusting  $I_{OUTFS}$ , the buffer amplifier  $I_{CM}$  value must be adjusted to correspond to  $I_{OUTFS}$ , which helps minimize the output common-mode voltage offset of the DAC to within acceptable levels to maintain performance.

The relationship between  $I_{OUTFS}$  and the ideal  $I_{CM}$  value,  $I_{CM\_IDEAL}$ , can be described by the following equation:

$$I_{CM\_IDEAL} = I_{OUTFS} / 2 + 3.8 \text{ mA}$$

With  $I_{CM\_IDEAL}$  known,  $I_{CM}$  at the amplifier input stage must be set to the nearest value, such that the error between  $I_{CM}$  and  $I_{CM\_IDEAL}$  is minimized.

The  $I_{CM}$  value can be adjusted digitally over a 6.4 mA to 30.4 mA range by the AMP\_ICM bits in amplifier Register 0x18. The following equation relates  $I_{CM}$  to the AMP\_ICM bits:

$$I_{CM} = 24 \text{ mA} \times (AMP\_ICM / 15) + 6.4 \text{ mA}$$

To minimize potential stress on the DAC output stage, adjust  $I_{OUTFS}$  and  $I_{CM}$  sequentially, as part of the same SPI write sequence.

## ANALOG OUTPUT

The AD9166 output is a single-ended, 50  $\Omega$ , internally terminated output with a bipolar output stage for ease of interface with broadband 50  $\Omega$  environments. The equivalent output circuit is shown in Figure 93, and the equivalent lumped element model is shown in Figure 94. The output stage is internally biased and terminated, with no external bias or termination components needed, and can be connected directly to downstream devices that present a 50  $\Omega$  ground referenced load. The maximum output voltage swing corresponds to  $+I_{OUTFS}$  to  $-I_{OUTFS}$ , and can be adjusted by modifying the  $I_{OUTFS}$  of the DAC, which results in a maximum output power into a 50  $\Omega$  load near 4 dBm.

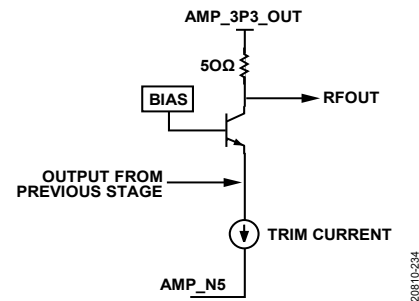
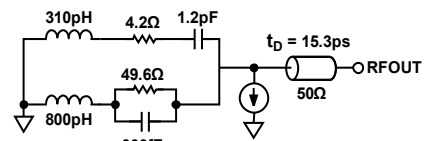

Figure 93. Equivalent Output Circuit to Pin RFOUT



NOTES  
 $t_D$  IS THE DELAY TIME.

Figure 94. Equivalent Lumped Element Model of the AD9166 Output at Pin RFOUT

The output dc offset voltage ( $V_{OS}$ ) at the RFOUT pin can be adjusted from its nominal value by writing to the VOUT\_TRIM bits in Amplifier Register 0x19. The full adjustment range is between 350 mV and  $-250$  mV relative to the nominal  $V_{OS}$  when  $VOUT\_TRIM = 0x6A$  and the offset voltage adjustment ( $V_{OS\_ADJ}$ ) = 0.0 V.

$V_{OS\_ADJ}$  is defined by the following equation:

$$V_{OS\_ADJ} = 0.6 \text{ V} \times VOUT\_TRIM / 255 - 0.25$$

where:

$V_{OS\_ADJ}$  is the voltage adjustment from the nominal value.

$VOUT\_TRIM$  is the bit value set in Amplifier Register 0x19.

To assist in high frequency PCB design and impedance matching the AD9166 output, a 50  $\Omega$  normalized Smith chart is provided,



showing the simulated output return loss (S22) of the amplifier output (see Figure 95), along with the equivalent lump element model shown in Figure 94.

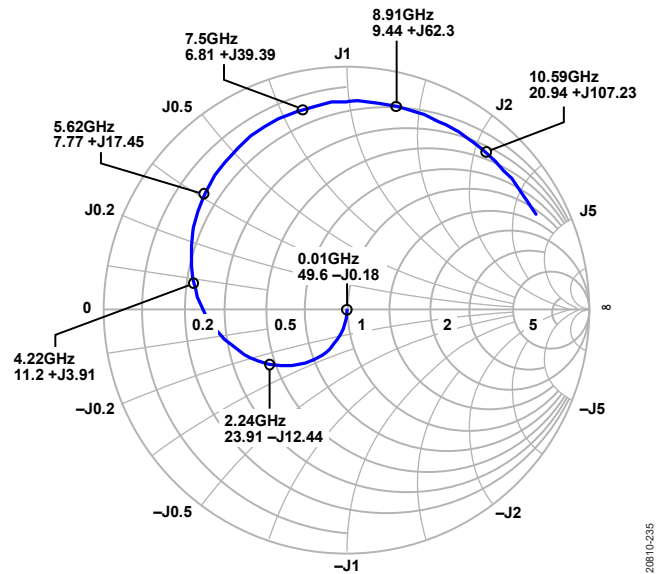

Figure 95. S22 vs. Frequency, Showing Output Impedance Relative to  $Z_0 = 50\Omega$

## TEMPERATURE SENSORS

The AD9166 has two junction temperature sensors, a DAC sensor and an amplifier sensor. The amplifier sensor monitors the temperature changes of the amplifier, and is located near the junction of the buffer amplifier. This sensor represents the junction temperature of the amplifier ( $T_{J\_AMP}$ ). The DAC sensor can help monitor the temperature changes of the DAC core, together with the digital interface inside the AD9166, and is located near the DAC core. This sensor represents the junction temperature of the DAC ( $T_{J\_DAC}$ ).

As the ambient temperature rises, the amplifier typically reaches its thermal limit before the DAC core. Therefore,  $T_{J\_AMP}$  determines the actual maximum safe operating temperature for both the amplifier and the DAC core inside the AD9166.

To avoid damage to the amplifier,  $T_{J\_AMP}$  must never exceed the limit defined in the Absolute Maximum Ratings section.

Before use, the sensors must be calibrated to remove the device to device variations on the band gap and the circuitry that senses the temperature. The temperature must be calibrated against a known temperature reference to determine either the slope or the intercept. This type of calibration is typically referred to as one-point calibration.

The measured temperature of either sensor,  $T_{MEAS}$ , is generally related to the temperature code by the following formula:

$$T_{MEAS} = M \times CODE\_X + T_{OFFSET} \quad (1)$$

where  $CODE\_X$  is the readback code at the unknown temperature,  $T_{MEAS}$ .

To minimize the error due to self heating during calibration, the AD9166 must be in a low power state with only the temperature measurement circuitry powered on.

### Amplifier Junction Temperature Sensor

The junction temperature sensor reading of the amplifier is derived from the following transfer functions:

$$V_{ADC} = V_{BGA} \times ((CODE\_X + 4)/255) \quad (2)$$

$$T_{MEAS} = 318.75 \times V_{ADC} + T_{OS} \quad (3)$$

where:

$V_{ADC}$  is the ADC input voltage reading sampled from the temperature sensor.

$V_{BGA}$  is the band gap voltage of the amplifier, with a nominal value of 1.09 V.

$CODE\_X$  is the ADC readback code at the unknown temperature,  $T_{MEAS}$ .

$T_{OS}$  is the offset of the transfer function to be determined by calibration

$T_{MEAS}$  is a temperature measurement directly proportional to the junction temperature of the amplifier ( $T_{J\_AMP}$ ).

$V_{BGA}$  can be measured at the device pin, and is nominally 1.09 V with an uncertainty of  $\pm 30$  mV over process variations in production, supply voltage variation across the specified range, and operating temperature range. The error due to  $V_{BGA}$  uncertainty is  $\pm 2.75\%$  over process, voltage, and temperature (PVT) and the full range of the temperature sensor. Most of the error is due to shifts in the manufacturing process, where the remaining variations over supply voltage and operating temperature account for only  $\sim 0.3\%$   $V_{BGA}$  uncertainty.

$T_{OS}$  is derived by applying a known temperature,  $T_{REF}$ , to the device case and recording the code,  $CODE\_REF$ , after the reading has settled to a constant value within the measurement uncertainty. During calibration, the AD9166 must be retained in a low power state so that the error due to internal power dissipation and self heating is minimized.

Equation 2 and Equation 3 can be combined to solve for  $T_{OS}$  after deriving  $T_{REF}$  and  $CODE\_REF$  during calibration.

$$T_{REF} = 318.75 \times V_{BGA} \times ((CODE\_REF + 4)/255) + T_{OS} \quad (4)$$

$$T_{OS} = T_{REF} - (318.75 \times V_{BGA} \times (CODE\_REF + 4)/255) \quad (5)$$

where:

$T_{REF}$  is the calibrated temperature at which the temperature sensor is read.

$CODE\_REF$  is the readback code at the measured temperature,  $T_{REF}$ .

With  $T_{OS}$  known,  $T_{J\_AMP}$  can be calculated from subsequent readback code,  $CODE\_x$ :

$$T_{MEAS} = 318.75 \times V_{BGA} \times ((CODE\_x + 4)/255) + T_{OS} \quad (6)$$

$$T_{J\_AMP} = T_{MEAS} + 5.5 \quad (7)$$

where:

$T_{J\_AMP}$  is the junction temperature of the amplifier.

$CODE\_x$  is the ADC readback code at the unknown temperature,  $T_{J\_AMP}$ .

Equation 7 is only valid if the temperature sensor is properly calibrated. To calibrate the sensor, reset the AD9166 before enabling the sensor so that minimal amount of power is drawn by the AD9166 and self heating due to internal power dissipation is minimized.

To enable the temperature sensor, make sure its sampling ADC is powered up (Amplifier Register 0x10, Bit 1 = 0b0). Set  $ST\_ADC\_CLKF\_0 = 0b1$  (Amplifier Register 0x1B, Bit 0). Wait at least 17 ADC clock cycles. ADC sampling clock rate can be adjusted using  $ST\_ADC\_CLKF\_1$  (Amplifier Register 0x1B, Bit 1), although the default 2 MHz clock setting is recommended. While the ADC is sampling the measurement, the  $ADC\_EOC$  bit stays low until the conversion is complete, at which point  $ADC\_EOC$  becomes high ( $ADC\_EOC = 0b1$ ). The ADC code can read from the  $ADC\_CODE$  bits (Amplifier Register 0x1D), where the  $ADC\_CODE$  represents  $CODE\_x$  in Equation 6.

### DAC Junction Temperature Sensor

The DAC temperature sensor reading is derived from the following transfer function:

$$T_{MEAS} = M \times (CODE\_x/1000) - 190 \quad (8)$$

where::

$CODE\_x$  is the readback code at the unknown temperature,  $T_{MEAS}$ .

$M$  is the slope of the transfer function to be determined by calibration.

$M$  is derived by applying a known temperature,  $T_{REF}$ , to the sensor and recording the code,  $CODE\_REF$ , after the reading

has settled to a constant value within the measurement uncertainty. Use the following equation to calculate  $M$ :

$$T_{REF} = M \times (CODE\_REF/1000) - 190 \quad (9)$$

$$M = (T_{REF} + 190)/(CODE\_REF/1000)$$

where:

$T_{REF}$  is the calibrated temperature at which the temperature sensor is read.

$CODE\_REF$  is the readback code at the measured temperature,  $T_{REF}$ .

Rearranging Equation 8 and plugging it into Equation 1 yields a transfer function that directly relates  $CODE\_REF$  and  $T_{REF}$  to the sensor reading, as follows:

$$190 = M \times (CODE\_REF/1000) - T_{REF}$$

$$T_{MEAS} = M \times (CODE\_x - CODE\_REF)/1000 + T_{REF}$$

where:

$CODE\_x$  is the readback code at the unknown temperature,

$T_{MEAS}$ .

$CODE\_REF$  is the readback code at the calibrated temperature,

$T_{REF}$ .

Equivalently, Equation 2 can be used directly, after  $M$  is derived from the one-point calibration procedure of Equation 1, described in the Temperature Sensors section, as follows:

$$T_{MEAS} = M \times (CODE\_x/1000) - 190$$

$$T_{J\_DAC} = T_{MEAS}$$

To calibrate the sensor, reset the AD9166 before enabling the sensor so that minimal amount of power is drawn by the AD9166 and self heating is minimized.

To enable the sensor, set Register 0x135 to 0xA1. The user must write 0b1 to Register 0x134, Bit 0, before reading back the die temperature from Register 0x132 (LSB) and Register 0x133 (MSB).

## START-UP SEQUENCE

Several steps are required to program the AD9166 to the proper operating state after the device is powered up according to the recommended power-up sequence (see the Power Sequencing section).

The start-up sequence is divided into several steps, and is listed in Table 42, Table 43, and Table 44, along with an explanation of the purpose of each step. Private registers are reserved but must be written for proper operation. Blank cells in Table 42 to Table 44 mean that the value depends on the result as described in the Description column.

The AD9166 is calibrated at the factory as part of the automatic test program. The configure DAC start-up sequence loads the factory calibration coefficients and configures some parameters

that optimize the performance of the DAC and the device clock DLL (see Table 42). Run this sequence whenever the DAC is powered down or reset.

The configure JESD204B sequence configures the SERDES block and then brings up the links (see Table 43). First, run the configure DAC start-up sequence, then run the configure JESD204B sequence.

Follow the configure NCO sequence if using the NCO (see Table 44). Note that the NCO can be used in NCO only mode or in conjunction with synthesized data from the SERDES data interface. Only one mode can be used at a time and this mode is selected in the second step in Table 44. The configure DAC start-up sequence is run first, then the configure NCO sequence.

**Table 42. Configure DAC Start-Up Sequence After Power-Up**

Register	Value	Description	R/W
0x000	0x18	Configure the device for 4-wire serial port operation (optional: leave at the default of 3-wire SPI).	W
0x0D2	0x52	Reset internal calibration registers (private).	W
0x0D2	0xD2	Clear the reset bit for the internal calibration registers (private).	W
0x606	0x02	Configure the nonvolatile random access memory (NVRAM) (private).	W
0x607	0x00	Configure the NVRAM (private).	W
0x604	0x01	Load the NVRAM. Loads factory calibration factors from the NVRAM (private).	W
0x003, 0x004, 0x005, 0x006	N/A <sup>1</sup>	Optional. Read CHIP_TYPE, PROD_ID, Bits[15:0], PROD_GRADE, and DEV_REVISION from Register 0x003, Register 0x004, Register 0x005, and Register 0x006.	R
0x604, Bit 1	0b1	Optional. Read the boot loader pass bit in Register 0x604, Bit 1 = 0b1 to indicate a completed boot load (private)	R
0x058	0x03	Enable the band gap reference (private).	W
0x090	0x1E	Power up the device clock DLL.	W
0x080	0x00	Enable the clock receiver.	W
0x040	0x00	Enable the DAC bias circuits.	W
0x09E	0x85	Configure DAC analog parameters (private).	W
0x091	0xE9	Enable the device clock DLL.	W
0x092, Bit 0	0b1	Check DLL_STATUS; set Register 0x092, Bit 0 = 1 to indicate the DLL is locked to the device clock input.	R
0x0E8	0x20	Enable calibration factors (private).	W
0x152, Bits[1:0]		Configure the DAC decode mode (0b00 = NRZ, 0b01 = mix mode, or 0b10 = RZ).	W

<sup>1</sup> N/A means not applicable.

Table 43. Configure JESD204B Start-Up Sequence

Register	Value	Description	R/W
0x300	0x00	Ensure the SERDES links are disabled before configuring them.	W
0x480	0x38	Enable SERDES error counters.	W
0x481	0x38	Enable SERDES error counters.	W
0x482	0x38	Enable SERDES error counters.	W
0x483	0x38	Enable SERDES error counters.	W
0x484	0x38	Enable SERDES error counters.	W
0x485	0x38	Enable SERDES error counters.	W
0x486	0x38	Enable SERDES error counters.	W
0x487	0x38	Enable SERDES error counters.	W
0x110		Configure number of lanes (Bits[7:4]) and interpolation rate (Bits[3:0]).	W
0x111		Configure the datapath options for Bit 7 (INVSINC_EN), Bit 6 (NCO_EN), Bit 4 (FILT_BW), Bit 2 (MODULUS_EN), Bit 1 (SEL_SIDEHAND), and Bit 0 (FIR85_FILT_EN). See the Register Summary section for details on the options. Set the reserved bits (Bit 5 and Bit 3) to 0b0.	W
0x230		Configure the CDR block according to Table 19 for both half rate enable and the divider.	W
0x289, Bits[1:0]		Set up the SERDES PLL divider based on the conditions shown in Table 18.	W
0x084, Bits[5:4]		Set up the PLL reference clock rate based on the conditions shown in Table 18.	W
0x200	0x00	Enable the JESD204B block (disable master SERDES power-down).	W
0x475	0x09	Soft reset the JESD204B quad-byte deframer.	W
0x453, Bit 7	0b1	Optional. Enable scrambling on SERDES lanes.	W
0x458, Bits[7:5]		Set the subclass type: 0b000 = Subclass 0, 0b001 = Subclass 1.	W
0x459, Bits[7:5]	0b1	Set the JESD204x version to JESD204B.	W
0x45D		Program the calculated checksum value for Lane 0 from values in Register 0x450 to Register 0x45C.	W
0x475	0x01	Bring the JESD204B quad-byte deframer out of reset.	W
0x201, Bits[7:0]		Set any bits to 1 to power down the appropriate physical lane.	W
0x2A7	0x01	Optional. Calibrate SERDES PHY Termination Block 1 (PHY 0, PHY 1, PHY 6, PHY 7).	W
0x2AE	0x01	Optional. Calibrate SERDES PHY Termination Block 2 (PHY 2, PHY 3, PHY 4, PHY 5).	W
0x29E	0x1F	Override defaults in the SERDES PLL settings (private).	W
0x280	0x03	Enable the SERDES PLL.	W
0x281, Bit 0	0b1	Read back Register 0x281 until Bit 0 = 1 to indicate the SERDES PLL is locked. Prior to enabling the link, be sure that the JESD204B transmitter is enabled and ready to begin link synchronization.	R
0x206	0x00	Reset the CDR to realign the sampling clock with the incoming data.	W
0x206	0x01	Bring the CDR out of reset.	W
0x300	0x01	Enable the JESD204B receiver to begin link synchronization. When $\overline{\text{SYNCOUT}}$ is asserted, the JESD204B transmitter begins CGS by sending /K/ characters.	W
0x470	0xFF	Read the CGS status for all lanes.	R
0x471	0xFF	Read the frame sync status for all lanes.	R
0x472	0xFF	Read the good checksum status for all lanes.	R
0x473	0xFF	Read the initial lane sync status for all lanes.	R
0x024	0x1F	Clear the datapath interrupts.	W
0x4BA	0xFF	Clear the SERDES interrupts.	W
0x4BB	0x01	Clear the SERDES interrupt.	W
0x020	0x0F	Optional. Enable the interrupts.	W
0x4B8	0xFF	Optional. Enable JESD204B interrupts.	W
0x4B9	0x01	Optional. Enable JESD204B interrupts.	W

Table 44. Configure NCO Sequence

Register	Value	Description	R/W
0x110	0x80	(Optional). Perform this write if NCO only mode is desired.	W
0x111, Bit 6	0b1	Configure NCO_EN (Bit 6) = 0b1. Configure other datapath options for Bit 7 (INVSINC_EN), Bit 4 (FILT_BW), Bit 2 (MODULUS_EN), Bit 1 (SEL_SIDE BAND), and Bit 0 (FIR85_FILT_EN). See the Register Summary section for details on the options. Set the reserved bits (Bit 5 and Bit 3) to 0b0.	W
0x150, Bit 1		Configure the DC_TEST_EN bit: 0b0 = NCO operation with data interface; 0b1 = NCO only mode.	W
0x14E		Write amplitude value for tone amplitude in NCO only mode (Bits[15:8]).	W
0x14F		Write amplitude value for tone amplitude in NCO only mode (Bits[7:0]).	W
0x113	0x00	Ensure the frequency tuning word write request is low.	W
0x119		Write FTW, Bits[47:40].	W
0x118		Write FTW, Bits[39:32].	W
0x117		Write FTW, Bits[31:24].	W
0x116		Write FTW, Bits[23:16].	W
0x115		Write FTW, Bits[15:8].	W
0x114		Write FTW, Bits[7:0].	W
0x113	0x01	Load the FTW to the NCO.	W

## REGISTER SUMMARY: DAC

Table 45. DAC Register Summary

Reg.	Name	Bits	Bit 7	Bit 6	Bit 5	Bit 4	Bit 3	Bit 2	Bit 1	Bit 0	Reset	RW		
0x000	SPI_INTFCONFA	[7:0]	SOFTRESET_M	LSBFIRST_M	ADDRINC_M	SDOACTIVE_M	SDOACTIVE	ADDRINC	LSBFIRST	SOFTRESET	0x00	R/W		
0x001	SPI_INTFCONFB	[7:0]	SINGLEINS	CSSTALL	Reserved			SOFTRESET1	SOFTRESET0	Reserved	0x00	R/W		
0x002	SPI_DEVCONF	[7:0]	DEVSTATUS				CUSTOPMODE			SYSOPMODE	0x00	R/W		
0x003	SPI_CHIPTYPE	[7:0]	CHIP_TYPE									0x00	R	
0x004	SPI_PRODIDL	[7:0]	PROD_ID[7:0]									0x00	R	
0x005	SPI_PRODIDH	[7:0]	PROD_ID[15:8]									0x00	R	
0x006	SPI_CHIPGRADE	[7:0]	PROD_GRADE				DEV_REVISION					0x00	R	
0x020	IRQ_ENABLE	[7:0]	Reserved			EN_SYSREF_JITTER	EN_DATA_READY	EN_LANE_FIFO	EN_PRBSQ	EN_PRBSI	0x00	R/W		
0x024	IRQ_STATUS	[7:0]	Reserved			IRQ_SYSREF_JITTER	IRQ_DATA_READY	IRQ_LANE_FIFO	IRQ_PRBSQ	IRQ_PRBSI	0x00	R/W		
0x031	SYNC_LMFC_DELAY_FRAME	[7:0]	Reserved			SYNC_LMFC_DELAY_SET_FRM					0x00	R/W		
0x032	SYNC_LMFC_DELAY0	[7:0]	SYNC_LMFC_DELAY_SET[7:0]									0x00	R/W	
0x033	SYNC_LMFC_DELAY1	[7:0]	Reserved				SYNC_LMFC_DELAY_SET[11:8]					0x00	R/W	
0x034	SYNC_LMFC_STAT0	[7:0]	SYNC_LMFC_DELAY_STAT[7:0]									0x00	R/W	
0x035	SYNC_LMFC_STAT1	[7:0]	Reserved				SYNC_LMFC_DELAY_STAT[11:8]					0x00	R/W	
0x036	SYSREF_COUNT	[7:0]	SYSREF_COUNT									0x00	R/W	
0x037	SYSREF_PHASE0	[7:0]	SYSREF_PHASE[7:0]									0x00	R/W	
0x038	SYSREF_PHASE1	[7:0]	Reserved				SYSREF_PHASE[11:8]					0x00	R/W	
0x039	SYSREF_JITTER_WINDOW	[7:0]	Reserved			SYSREF_JITTER_WINDOW						0x00	R/W	
0x03A	SYNC_CTRL	[7:0]	Reserved							SYNC_MODE		0x00	R/W	
0x03F	TX_ENABLE	[7:0]	SPI_DATAPATH_POST	SPI_DATAPATH_PRE	Reserved		TXEN_NCO_RESET	TXEN_DATAPATH_POST	TXEN_DATAPATH_PRE	TXEN_DAC_FSC	0xC0	R/W		
0x040	ANA_DAC_BIAS_PD	[7:0]	Reserved						ANA_DAC_BIAS_PD1	ANA_DAC_BIAS_PD0	0x03	R/W		
0x041	ANA_FSC0	[7:0]	Reserved						ANA_FULL_SCALE_CURRENT[1:0]			0x03	R/W	
0x042	ANA_FSC1	[7:0]	ANA_FULL_SCALE_CURRENT[9:2]									0xFF	R/W	
0x07F	CLK_PHASE_TUNE	[7:0]	Reserved			CLK_PHASE_TUNE						0x00	R/W	
0x080	CLK_PD	[7:0]	Reserved								DACCLK_PD	0x01	R/W	
0x082	CLK_DUTY	[7:0]	CLK_DUTY_EN	CLK_DUTY_OFFSET_EN	CLK_DUTY_BOOST_EN	CLK_DUTY_PRG						0x80	R/W	
0x083	CLK_CRIS_CTRL	[7:0]	CLK_CRIS_EN	Reserved			CLK_CRIS_ADJ					0x80	R/W	
0x084	PLL_REF_CLK_PD	[7:0]	Reserved		PLL_REF_CLK_RATE		Reserved			PLL_REF_CLK_PD	0x00	R/W		
0x088	SYSREF_CTRL0	[7:0]	Reserved				HYS_ON	SYSREF_RISE	HYS_CNTRL[9:8]				0x00	R/W
0x089	SYSREF_CTRL1	[7:0]	HYS_CNTRL[7:0]									0x00	R/W	
0x090	DLL_PD	[7:0]	Reserved			DLL_FINE_DC_EN	DLL_FINE_XC_EN	DLL_COARSE_DC_EN	DLL_COARSE_XC_EN	DLL_CLK_PD	0x1F	R/W		
0x091	DLL_CTRL	[7:0]	DLL_TRACK_ERR	DLL_SEARCH_ERR	DLL_SLOPE	DLL_SEARCH		DLL_MODE		DLL_ENABLE	0xF0	R/W		
0x092	DLL_STATUS	[7:0]	Reserved						DLL_FAIL	DLL_LOST	DLL_LOCKED	0x00	R/W	
0x093	DLL_GB	[7:0]	Reserved				DLL_GUARD					0x00	R/W	
0x094	DLL_COARSE	[7:0]	Reserved			DLL_COARSE						0x00	R/W	

Reg.	Name	Bits	Bit 7	Bit 6	Bit 5	Bit 4	Bit 3	Bit 2	Bit 1	Bit 0	Reset	RW	
0x095	DLL_FINE	[7:0]	DLL_FINE									0x80	R/W
0x096	DLL_PHASE	[7:0]	Reserved			DLL_PHS						0x08	R/W
0x097	DLL_BW	[7:0]	Reserved			DLL_FILT_BW			DLL_WEIGHT		0x00	R/W	
0x098	DLL_READ	[7:0]	Reserved								DLL_READ	0x00	R/W
0x099	DLL_COARSE_RB	[7:0]	Reserved		DLL_COARSE_RB						0x00	R	
0x09A	DLL_FINE_RB	[7:0]	DLL_FINE_RB									0x00	R
0x09B	DLL_PHASE_RB	[7:0]	Reserved			DLL_PHS_RB						0x00	R
0x09D	DIG_CLK_INVERT	[7:0]	Reserved					INV_DIG_CLK	DIG_CLK_DC_EN	DIG_CLK_XC_EN	0x03	R/W	
0x0A0	DLL_CLK_DEBUG	[7:0]	DLL_TEST_EN	Reserved					DLL_TEST_DIV		0x00	R/W	
0x110	INTERP_MODE	[7:0]	JESD_LANES				INTERP_MODE					0x81	R/W
0x111	DATAPATH_CFG	[7:0]	INVSINC_EN	NCO_EN	Reserved	FILT_BW	Reserved	MODULUS_EN	SEL_SIDE BAND	FIR5_FILTER_EN	0x00	R/W	
0x113	FTW_UPDATE	[7:0]	Reserved	FTW_REQ_MODE			Reserved	FTW_LOAD_SYSREF	FTW_LOAD_ACK	FTW_LOAD_REQ	0x00	R/W	
0x114	FTW0	[7:0]	FTW[7:0]									0x00	R/W
0x115	FTW1	[7:0]	FTW[15:8]									0x00	R/W
0x116	FTW2	[7:0]	FTW[23:16]									0x00	R/W
0x117	FTW3	[7:0]	FTW[31:24]									0x00	R/W
0x118	FTW4	[7:0]	FTW[39:32]									0x00	R/W
0x119	FTW5	[7:0]	FTW[47:40]									0x00	R/W
0x11C	PHASE_OFFSET0	[7:0]	NCO_PHASE_OFFSET[7:0]									0x00	R/W
0x11D	PHASE_OFFSET1	[7:0]	NCO_PHASE_OFFSET[15:8]									0x00	R/W
0x124	ACC_MODULUS0	[7:0]	ACC_MODULUS[7:0]									0x00	R/W
0x125	ACC_MODULUS1	[7:0]	ACC_MODULUS[15:8]									0x00	R/W
0x126	ACC_MODULUS2	[7:0]	ACC_MODULUS[23:16]									0x00	R/W
0x127	ACC_MODULUS3	[7:0]	ACC_MODULUS[31:24]									0x00	R/W
0x128	ACC_MODULUS4	[7:0]	ACC_MODULUS[39:32]									0x00	R/W
0x129	ACC_MODULUS5	[7:0]	ACC_MODULUS[47:40]									0x00	R/W
0x12A	ACC_DELTA0	[7:0]	ACC_DELTA[7:0]									0x00	R/W
0x12B	ACC_DELTA1	[7:0]	ACC_DELTA[15:8]									0x00	R/W
0x12C	ACC_DELTA2	[7:0]	ACC_DELTA[23:16]									0x00	R/W
0x12D	ACC_DELTA3	[7:0]	ACC_DELTA[31:24]									0x00	R/W
0x12E	ACC_DELTA4	[7:0]	ACC_DELTA[39:32]									0x00	R/W
0x12F	ACC_DELTA5	[7:0]	ACC_DELTA[47:40]									0x00	R/W
0x132	TEMP_SENS_LSB	[7:0]	TEMP_SENS_OUT[7:0]										R
0x133	TEMP_SENS_MSB	[7:0]	TEMP_SENS_OUT[15:8]										R
0x134	TEMP_SENS_UPDATE	[7:0]	Reserved								TEMP_SENS_UPDATE	0x00	R/W
0x135	TEMP_SENS_CTRL	[7:0]	TEMP_SENS_FAST	Reserved						TEMP_SENS_ENABLE		R/W	
0x14B	PRBS	[7:0]	PRBS_GOOD_Q	PRBS_GOOD_I	Reserved	PRBS_INV_Q	PRBS_INV_I	PRBS_MODE	PRBS_RESET	PRBS_EN	0x10	R/W	
0x14C	PRBS_ERROR_I	[7:0]	PRBS_COUNT_I									0x00	R
0x14D	PRBS_ERROR_Q	[7:0]	PRBS_COUNT_Q									0x00	R
0x14E	TEST_DC_DATA1	[7:0]	DC_TEST_DATA[15:8]									0x00	R/W

Reg.	Name	Bits	Bit 7	Bit 6	Bit 5	Bit 4	Bit 3	Bit 2	Bit 1	Bit 0	Reset	RW	
0x14F	TEST_DC_DATA0	[7:0]	DC_TEST_DATA[7:0]								0x00	R/W	
0x150	DIG_TEST	[7:0]	Reserved						DC_TEST_EN	Reserved	0x00	R/W	
0x151	DECODE_CTRL	[7:0]	Reserved				Shuffle	Reserved			0x01	R/W	
0x152	DECODE_MODE	[7:0]	Reserved						DECODE_MODE		0x00	R/W	
0x1DF	SPI_STRENGTH	[7:0]	Reserved				SPIDRV				0x0F	R/W	
0x200	MASTER_PD	[7:0]	Reserved							SPI_PD_MASTER	0x01	R/W	
0x201	PHY_PD	[7:0]	SPI_PD_PHY									0x00	R/W
0x203	GENERIC_PD	[7:0]	Reserved						SPI_SYNC1_PD	Reserved	0x00	R/W	
0x206	CDR_RESET	[7:0]	Reserved							SPI_CDR_RESET	0x01	R/W	
0x230	CDR_OPERATING_MODE_REG_0	[7:0]	Reserved	SPI_ENHALFRATE	Reserved		SPI_DIVISION_RATE		Reserved	0x28	R/W		
0x250	EQ_CONFIG_PHY_0_1	[7:0]	SPI_EQ_CONFIG1				SPI_EQ_CONFIG0				0x88	R/W	
0x251	EQ_CONFIG_PHY_2_3	[7:0]	SPI_EQ_CONFIG3				SPI_EQ_CONFIG2				0x88	R/W	
0x252	EQ_CONFIG_PHY_4_5	[7:0]	SPI_EQ_CONFIG5				SPI_EQ_CONFIG4				0x88	R/W	
0x253	EQ_CONFIG_PHY_6_7	[7:0]	SPI_EQ_CONFIG7				SPI_EQ_CONFIG6				0x88	R/W	
0x268	EQ_BIAS_REG	[7:0]	EQ_POWER_MODE	Reserved								0x62	R/W
0x280	SYNTH_ENABLE_CNTRL	[7:0]	Reserved					SPI_RECAL_SYNTH	Reserved	SPI_ENABLE_SYNTH	0x00	R/W	
0x281	PLL_STATUS	[7:0]	Reserved	SPI_CP_OVER_RANGE_HIGH_RB	SPI_CP_OVER_RANGE_LOW_RB	SPI_CP_CAL_VALID_RB	Reserved			SPI_PLL_LOCK_RB	0x00	R	
0x289	REF_CLK_DIVIDER_LDO	[7:0]	Reserved						SERDES_PLL_DIV_FACTOR		0x04	R/W	
0x2A7	TERM_BLK1_CTRLREG0	[7:0]	Reserved							SPI_I_TUNE_R_CAL_TERMBLK1	0x00	R/W	
0x2A8	TERM_BLK1_CTRLREG1	[7:0]	SPI_I_SERIALIZER_RTRIM_TERMBLK1									0x00	R/W
0x2AC	TERM_BLK1_RD_REG0	[7:0]	Reserved				SPI_O_RCAL_CODE_TERMBLK1				0x00	R	
0x2AE	TERM_BLK2_CTRLREG0	[7:0]	Reserved							SPI_I_TUNE_R_CAL_TERMBLK2	0x00	R/W	
0x2AF	TERM_BLK2_CTRLREG1	[7:0]	SPI_I_SERIALIZER_RTRIM_TERMBLK2									0x00	R/W
0x2B3	TERM_BLK2_RD_REG0	[7:0]	Reserved				SPI_O_RCAL_CODE_TERMBLK2				0x00	R	
0x2BB	TERM_OFFSET_0	[7:0]	Reserved				TERM_OFFSET_0				0x00	R/W	
0x2BC	TERM_OFFSET_1	[7:0]	Reserved				TERM_OFFSET_1				0x00	R/W	
0x2BD	TERM_OFFSET_2	[7:0]	Reserved				TERM_OFFSET_2				0x00	R/W	
0x2BE	TERM_OFFSET_3	[7:0]	Reserved				TERM_OFFSET_3				0x00	R/W	
0x2BF	TERM_OFFSET_4	[7:0]	Reserved				TERM_OFFSET_4				0x00	R/W	
0x2C0	TERM_OFFSET_5	[7:0]	Reserved				TERM_OFFSET_5				0x00	R/W	
0x2C1	TERM_OFFSET_6	[7:0]	Reserved				TERM_OFFSET_6				0x00	R/W	



Reg.	Name	Bits	Bit 7	Bit 6	Bit 5	Bit 4	Bit 3	Bit 2	Bit 1	Bit 0	Reset	RW
0x2C2	TERM_OFFSET_7	[7:0]	Reserved				TERM_OFFSET_7				0x00	R/W
0x300	GENERAL_JRX_CTRL_0	[7:0]	Reserved	CHECKSUM_MODE	Reserved				LINK_EN		0x00	R/W
0x302	DYN_LINK_LATENCY_0	[7:0]	Reserved			DYN_LINK_LATENCY_0				0x00	R	
0x304	LMFC_DELAY_0	[7:0]	Reserved			LMFC_DELAY_0				0x00	R/W	
0x306	LMFC_VAR_0	[7:0]	Reserved			LMFC_VAR_0				0x1F	R/W	
0x308	XBAR_LN_0_1	[7:0]	Reserved		SRC_LANE1		SRC_LANE0			0x08	R/W	
0x309	XBAR_LN_2_3	[7:0]	Reserved		SRC_LANE3		SRC_LANE2			0x1A	R/W	
0x30A	XBAR_LN_4_5	[7:0]	Reserved		SRC_LANE5		SRC_LANE4			0x2C	R/W	
0x30B	XBAR_LN_6_7	[7:0]	Reserved		SRC_LANE7		SRC_LANE6			0x3E	R/W	
0x30C	FIFO_STATUS_REG_0	[7:0]	LANE_FIFO_FULL								0x00	R
0x30D	FIFO_STATUS_REG_1	[7:0]	LANE_FIFO_EMPTY								0x00	R
0x311	SYNC_GEN_0	[7:0]	Reserved				EOMF_MASK_0		Reserved	EOF_MASK_0	0x00	R/W
0x312	SYNC_GEN_1	[7:0]	SYNC_ERR_DUR			SYNC_SYNCREQ_DUR				0x00	R/W	
0x313	SYNC_GEN_3	[7:0]	LMFC_PERIOD								0x00	R
0x315	PHY_PRBS_TEST_EN	[7:0]	PHY_TEST_EN								0x00	R/W
0x316	PHY_PRBS_TEST_CTRL	[7:0]	Reserved	PHY_SRC_ERR_CNT			PHY_PRBS_PAT_SEL		PHY_TEST_START	PHY_TEST_RESET	0x00	R/W
0x317	PHY_PRBS_TEST_THRESHOLD_LOBITS	[7:0]	PHY_PRBS_THRESHOLD_LOBITS								0x00	R/W
0x318	PHY_PRBS_TEST_THRESHOLD_MIDBITS	[7:0]	PHY_PRBS_THRESHOLD_MIDBITS								0x00	R/W
0x319	PHY_PRBS_TEST_THRESHOLD_HIBITS	[7:0]	PHY_PRBS_THRESHOLD_HIBITS								0x00	R/W
0x31A	PHY_PRBS_TEST_ERRCNT_LOBITS	[7:0]	PHY_PRBS_ERR_CNT_LOBITS								0x00	R
0x31B	PHY_PRBS_TEST_ERRCNT_MIDBITS	[7:0]	PHY_PRBS_ERR_CNT_MIDBITS								0x00	R
0x31C	PHY_PRBS_TEST_ERRCNT_HIBITS	[7:0]	PHY_PRBS_ERR_CNT_HIBITS								0x00	R
0x31D	PHY_PRBS_TEST_STATUS	[7:0]	PHY_PRBS_PASS								0xFF	R
0x31E	PHY_DATA_SNAPSHOT_CTRL	[7:0]	Reserved			PHY_GRAB_LANE_SEL			PHY_GRAB_MODE	PHY_GRAB_DATA	0x00	R/W
0x31F	PHY_SNAPSHOT_DATA_BYTE0	[7:0]	PHY_SNAPSHOT_DATA_BYTE0								0x00	R
0x320	PHY_SNAPSHOT_DATA_BYTE1	[7:0]	PHY_SNAPSHOT_DATA_BYTE1								0x00	R
0x321	PHY_SNAPSHOT_DATA_BYTE2	[7:0]	PHY_SNAPSHOT_DATA_BYTE2								0x00	R
0x322	PHY_SNAPSHOT_DATA_BYTE3	[7:0]	PHY_SNAPSHOT_DATA_BYTE3								0x00	R
0x323	PHY_SNAPSHOT_DATA_BYTE4	[7:0]	PHY_SNAPSHOT_DATA_BYTE4								0x00	R
0x32C	SHORT_TPL_TEST_0	[7:0]	SHORT_TPL_SP_SEL				SHORT_TPL_M_SEL		SHORT_TPL_TEST_RESET	SHORT_TPL_TEST_EN	0x00	R/W

Reg.	Name	Bits	Bit 7	Bit 6	Bit 5	Bit 4	Bit 3	Bit 2	Bit 1	Bit 0	Reset	RW	
0x32D	SHORT_TPL_TEST_1	[7:0]	SHORT_TPL_REF_SP_LSB								0x00	R/W	
0x32E	SHORT_TPL_TEST_2	[7:0]	SHORT_TPL_REF_SP_MSB								0x00	R/W	
0x32F	SHORT_TPL_TEST_3	[7:0]	Reserved								SHORT_TPL_FAIL	0x00	R
0x334	JESD_BIT_INVERSE_CTRL	[7:0]	JESD_BIT_INVERSE								0x00	R/W	
0x400	DID_REG	[7:0]	DID_RD								0x00	R	
0x401	BID_REG	[7:0]	BID_RD								0x00	R	
0x402	LID0_REG	[7:0]	Reserved	ADJDIR_RD	PHADJ_RD	LL_LID0				0x00	R		
0x403	SCR_L_REG	[7:0]	SCR_RD	Reserved			L_RD				0x00	R	
0x404	F_REG	[7:0]	F_RD								0x00	R	
0x405	K_REG	[7:0]	Reserved				K_RD				0x00	R	
0x406	M_REG	[7:0]	M_RD								0x00	R	
0x407	CS_N_REG	[7:0]	CS_RD		Reserved			N_RD			0x00	R	
0x408	NP_REG	[7:0]	SUBCLASSV_RD				NP_RD				0x00	R	
0x409	S_REG	[7:0]	JESDV_RD				S_RD				0x00	R	
0x40A	HD_CF_REG	[7:0]	HD_RD	Reserved			CF_RD				0x00	R	
0x40B	RES1_REG	[7:0]	RES1_RD								0x00	R	
0x40C	RES2_REG	[7:0]	RES2_RD								0x00	R	
0x40D	CHECKSUM0_REG	[7:0]	LL_FCHK0								0x00	R	
0x40E	COMPNUM0_REG	[7:0]	LL_FCMP0								0x00	R	
0x412	LID1_REG	[7:0]	Reserved				LL_LID1				0x00	R	
0x415	CHECKSUM1_REG	[7:0]	LL_FCHK1								0x00	R	
0x416	COMPNUM1_REG	[7:0]	LL_FCMP1								0x00	R	
0x41A	LID2_REG	[7:0]	Reserved				LL_LID2				0x00	R	
0x41D	CHECKSUM2_REG	[7:0]	LL_FCHK2								0x00	R	
0x41E	COMPNUM2_REG	[7:0]	LL_FCMP2								0x00	R	
0x422	LID3_REG	[7:0]	Reserved				LL_LID3				0x00	R	
0x425	CHECKSUM3_REG	[7:0]	LL_FCHK3								0x00	R	
0x426	COMPNUM3_REG	[7:0]	LL_FCMP3								0x00	R	
0x42A	LID4_REG	[7:0]	Reserved				LL_LID4				0x00	R	
0x42D	CHECKSUM4_REG	[7:0]	LL_FCHK4								0x00	R	
0x42E	COMPNUM4_REG	[7:0]	LL_FCMP4								0x00	R	
0x432	LID5_REG	[7:0]	Reserved				LL_LID5				0x00	R	
0x435	CHECKSUM5_REG	[7:0]	LL_FCHK5								0x00	R	
0x436	COMPNUM5_REG	[7:0]	LL_FCMP5								0x00	R	
0x43A	LID6_REG	[7:0]	Reserved				LL_LID6				0x00	R	
0x43D	CHECKSUM6_REG	[7:0]	LL_FCHK6								0x00	R	
0x43E	COMPNUM6_REG	[7:0]	LL_FCMP6								0x00	R	
0x442	LID7_REG	[7:0]	Reserved				LL_LID7				0x00	R	
0x445	CHECKSUM7_REG	[7:0]	LL_FCHK7								0x00	R	
0x446	COMPNUM7_REG	[7:0]	LL_FCMP7								0x00	R	

Reg.	Name	Bits	Bit 7	Bit 6	Bit 5	Bit 4	Bit 3	Bit 2	Bit 1	Bit 0	Reset	RW	
0x450	ILS_DID	[7:0]	DID								0x00	R/W	
0x451	ILS_BID	[7:0]	BID								0x00	R/W	
0x452	ILS_LID0	[7:0]	Reserved	ADJDIR	PHADJ	LID0				0x00	R/W		
0x453	ILS_SCR_L	[7:0]	SCR	Reserved			L				0x87	R/W	
0x454	ILS_F	[7:0]	F								0x00	R	
0x455	ILS_K	[7:0]	Reserved				K				0x1F	R/W	
0x456	ILS_M	[7:0]	M								0x01	R	
0x457	ILS_CS_N	[7:0]	CS		Reserved			N			0x0F	R	
0x458	ILS_NP	[7:0]	SUBCLASSV						NP		0x0F	R/W	
0x459	ILS_S	[7:0]	JESDV						S		0x01	R/W	
0x45A	ILS_HD_CF	[7:0]	HD	Reserved			CF			0x80	R		
0x45B	ILS_RES1	[7:0]	RES1								0x00	R/W	
0x45C	ILS_RES2	[7:0]	RES2								0x00	R/W	
0x45D	ILS_CHECKSUM	[7:0]	FCHK0								0x00	R/W	
0x46C	LANE_DESKEW	[7:0]	ILD7	ILS6	ILD5	ILD4	ILD3	ILD2	ILD1	ILD0	0x00	R	
0x46D	BAD_DISPARITY	[7:0]	BDE7	BDE6	BDE5	BDE4	BDE3	BDE2	BDE1	BDE0	0x00	R	
0x46E	NOT_IN_TABLE	[7:0]	NIT7	NIT6	NIT5	NIT4	NIT3	NIT2	NIT1	NIT0	0x00	R	
0x46F	UNEXPECTED_KCHAR	[7:0]	UEK7	UEK6	UEK5	UEK4	UEK3	UEK2	UEK1	UEK0	0x00	R	
0x470	CODE_GRP_SYNC	[7:0]	CGS7	CGS6	CGS5	CGS4	CGS3	CGS2	CGS1	CGS0	0x00	R	
0x471	FRAME_SYNC	[7:0]	FS7	FS6	FS5	FS4	FS3	FS2	FS1	FS0	0x00	R	
0x472	GOOD_CHECKSUM	[7:0]	CKS7	CKS6	CKS5	CKS4	CKS3	CKS2	CKS1	CKS0	0x00	R	
0x473	INIT_LANE_SYNC	[7:0]	ILS7	ILS6	ILS5	ILS4	ILS3	ILS2	ILS1	ILS0	0x00	R	
0x475	CTRLREG0	[7:0]	RX_DIS	CHAR_REPL_DIS	Reserved		SOFRST	FORCESYNCREQ	Reserved	REPL_FRM_ENA	0x01	R/W	
0x476	CTRLREG1	[7:0]	Reserved			QUAL_RDERR	DEL_SCR	CGS_SEL	NO_ILAS	FCHK_N	0x14	R/W	
0x477	CTRLREG2	[7:0]	ILS_MODE	Reserved	REPDATA TEST	QUETESTERR	AR_ECNT	Reserved			0x00	R/W	
0x478	KVAL	[7:0]	KSYNC								0x01	R/W	
0x47C	ERRORTHRES	[7:0]	ETH								0xFF	R/W	
0x47D	SYNC_ASSERT_MASK	[7:0]	Reserved					SYNC_ASSERT_MASK				0x07	R/W
0x480	ECNT_CTRL0	[7:0]	Reserved			ECNT_ENA0		ECNT_RST0			0x3F	R/W	
0x481	ECNT_CTRL1	[7:0]	Reserved			ECNT_ENA1		ECNT_RST1			0x3F	R/W	
0x482	ECNT_CTRL2	[7:0]	Reserved			ECNT_ENA2		ECNT_RST2			0x3F	R/W	
0x483	ECNT_CTRL3	[7:0]	Reserved			ECNT_ENA3		ECNT_RST3			0x3F	R/W	
0x484	ECNT_CTRL4	[7:0]	Reserved			ECNT_ENA4		ECNT_RST4			0x3F	R/W	
0x485	ECNT_CTRL5	[7:0]	Reserved			ECNT_ENA5		ECNT_RST5			0x3F	R/W	
0x486	ECNT_CTRL6	[7:0]	Reserved			ECNT_ENA6		ECNT_RST6			0x3F	R/W	
0x487	ECNT_CTRL7	[7:0]	Reserved			ECNT_ENA7		ECNT_RST7			0x3F	R/W	
0x488	ECNT_TCH0	[7:0]	Reserved					ECNT_TCH0			0x07	R/W	
0x489	ECNT_TCH1	[7:0]	Reserved					ECNT_TCH1			0x07	R/W	
0x48A	ECNT_TCH2	[7:0]	Reserved					ECNT_TCH2			0x07	R/W	
0x48B	ECNT_TCH3	[7:0]	Reserved					ECNT_TCH3			0x07	R/W	
0x48C	ECNT_TCH4	[7:0]	Reserved					ECNT_TCH4			0x07	R/W	
0x48D	ECNT_TCH5	[7:0]	Reserved					ECNT_TCH5			0x07	R/W	
0x48E	ECNT_TCH6	[7:0]	Reserved					ECNT_TCH6			0x07	R/W	
0x48F	ECNT_TCH7	[7:0]	Reserved					ECNT_TCH7			0x07	R/W	
0x490	ECNT_STAT0	[7:0]	Reserved				LANE_ENA0		ECNT_TCR0			0x00	R
0x491	ECNT_STAT1	[7:0]	Reserved				LANE_ENA1		ECNT_TCR1			0x00	R
0x492	ECNT_STAT2	[7:0]	Reserved				LANE_ENA2		ECNT_TCR2			0x00	R
0x493	ECNT_STAT3	[7:0]	Reserved				LANE_ENA3		ECNT_TCR3			0x00	R
0x494	ECNT_STAT4	[7:0]	Reserved				LANE_ENA4		ECNT_TCR4			0x00	R
0x495	ECNT_STAT5	[7:0]	Reserved				LANE_ENA5		ECNT_TCR5			0x00	R
0x496	ECNT_STAT6	[7:0]	Reserved				LANE_ENA6		ECNT_TCR6			0x00	R

Reg.	Name	Bits	Bit 7	Bit 6	Bit 5	Bit 4	Bit 3	Bit 2	Bit 1	Bit 0	Reset	RW	
0x497	ECNT_STAT7	[7:0]	Reserved				LANE_ENA7	ECNT_TCR7				0x00	R
0x498	BD_CNT0	[7:0]					BD_CNT0					0x00	R
0x499	BD_CNT1	[7:0]					BD_CNT1					0x00	R
0x49A	BD_CNT2	[7:0]					BD_CNT2					0x00	R
0x49B	BD_CNT3	[7:0]					BD_CNT3					0x00	R
0x49C	BD_CNT4	[7:0]					BD_CNT4					0x00	R
0x49D	BD_CNT5	[7:0]					BD_CNT5					0x00	R
0x49E	BD_CNT6	[7:0]					BD_CNT6					0x00	R
0x49F	BD_CNT7	[7:0]					BD_CNT7					0x00	R
0x4A0	NIT_CNT0	[7:0]					NIT_CNT0					0x00	R
0x4A1	NIT_CNT1	[7:0]					NIT_CNT1					0x00	R
0x4A2	NIT_CNT2	[7:0]					NIT_CNT2					0x00	R
0x4A3	NIT_CNT3	[7:0]					NIT_CNT3					0x00	R
0x4A4	NIT_CNT4	[7:0]					NIT_CNT4					0x00	R
0x4A5	NIT_CNT5	[7:0]					NIT_CNT5					0x00	R
0x4A6	NIT_CNT6	[7:0]					NIT_CNT6					0x00	R
0x4A7	NIT_CNT7	[7:0]					NIT_CNT7					0x00	R
0x4A8	UEK_CNT0	[7:0]					UEK_CNT0					0x00	R
0x4A9	UEK_CNT1	[7:0]					UEK_CNT1					0x00	R
0x4AA	UEK_CNT2	[7:0]					UEK_CNT2					0x00	R
0x4AB	UEK_CNT3	[7:0]					UEK_CNT3					0x00	R
0x4AC	UEK_CNT4	[7:0]					UEK_CNT4					0x00	R
0x4AD	UEK_CNT5	[7:0]					UEK_CNT5					0x00	R
0x4AE	UEK_CNT6	[7:0]					UEK_CNT6					0x00	R
0x4AF	UEK_CNT7	[7:0]					UEK_CNT7					0x00	R
0x4B0	LINK_STATUS0	[7:0]	BDE0	NIT0	UEK0	ILD0	ILS0	CKS0	FS0	CGS0	0x00	R	
0x4B1	LINK_STATUS1	[7:0]	BDE1	NIT1	UEK1	ILD1	ILS1	CKS1	FS1	CGS1	0x00	R	
0x4B2	LINK_STATUS2	[7:0]	BDE2	NIT2	UEK2	ILD2	ILS2	CKS2	FS2	CGS2	0x00	R	
0x4B3	LINK_STATUS3	[7:0]	BDE3	NIT3	UEK3	ILD3	ILS3	CKS3	FS3	CGS3	0x00	R	
0x4B4	LINK_STATUS4	[7:0]	BDE4	NIT4	UEK4	ILD4	ILS4	CKS4	FS4	CGS4	0x00	R	
0x4B5	LINK_STATUS5	[7:0]	BDE5	NIT5	UEK5	ILD5	ILS5	CKS5	FS5	CGS5	0x00	R	
0x4B6	LINK_STATUS6	[7:0]	BDE6	NIT6	UEK6	ILD6	ILS6	CKS6	FS6	CGS6	0x00	R	
0x4B7	LINK_STATUS7	[7:0]	BDE7	NIT7	UEK7	ILD7	ILS7	CKS7	FS7	CGS7	0x00	R	
0x4B8	JESD_IRQ_ENABLEA	[7:0]	EN_BDE	EN_NIT	EN_UEK	EN_ILD	EN_ILS	EN_CKS	EN_FS	EN_CGS	0x00	R/W	
0x4B9	JESD_IRQ_ENABLEB	[7:0]	Reserved							EN_ILAS	0x00	R/W	
0x4BA	JESD_IRQ_STATUSA	[7:0]	IRQ_BDE	IRQ_NIT	IRQ_UEK	IRQ_ILD	IRQ_ILS	IRQ_CKS	IRQ_FS	IRQ_CGS	0x00	R/W	
0x4BB	JESD_IRQ_STATUSB	[7:0]	Reserved							IRQ_ILAS	0x00	R/W	
0x800	HOPF_CTRL	[7:0]	HOPF_MODE		Reserved	HOPF_SEL					0x00	R/W	
0x806	HOPF_FTW1_0	[7:0]					HOPF_FTW1[7:0]				0x00	R/W	
0x807	HOPF_FTW1_1	[7:0]					HOPF_FTW1[15:8]				0x00	R/W	
0x808	HOPF_FTW1_2	[7:0]					HOPF_FTW1[23:16]				0x00	R/W	
0x809	HOPF_FTW1_3	[7:0]					HOPF_FTW1[31:24]				0x00	R/W	
0x80A	HOPF_FTW2_0	[7:0]					HOPF_FTW2[7:0]				0x00	R/W	
0x80B	HOPF_FTW2_1	[7:0]					HOPF_FTW2[15:8]				0x00	R/W	
0x80C	HOPF_FTW2_2	[7:0]					HOPF_FTW2[23:16]				0x00	R/W	
0x80D	HOPF_FTW2_3	[7:0]					HOPF_FTW2[31:24]				0x00	R/W	
0x80E	HOPF_FTW3_0	[7:0]					HOPF_FTW3[7:0]				0x00	R/W	
0x80F	HOPF_FTW3_1	[7:0]					HOPF_FTW3[15:8]				0x00	R/W	
0x810	HOPF_FTW3_2	[7:0]					HOPF_FTW3[23:16]				0x00	R/W	
0x811	HOPF_FTW3_3	[7:0]					HOPF_FTW3[31:24]				0x00	R/W	
0x812	HOPF_FTW4_0	[7:0]					HOPF_FTW4[7:0]				0x00	R/W	
0x813	HOPF_FTW4_1	[7:0]					HOPF_FTW4[15:8]				0x00	R/W	
0x814	HOPF_FTW4_2	[7:0]					HOPF_FTW4[23:16]				0x00	R/W	

Reg.	Name	Bits	Bit 7	Bit 6	Bit 5	Bit 4	Bit 3	Bit 2	Bit 1	Bit 0	Reset	RW
0x815	HOPF_FTW4_3	[7:0]					HOPF_FTW4[31:24]				0x00	R/W
0x816	HOPF_FTW5_0	[7:0]					HOPF_FTW5[7:0]				0x00	R/W
0x817	HOPF_FTW5_1	[7:0]					HOPF_FTW5[15:8]				0x00	R/W
0x818	HOPF_FTW5_2	[7:0]					HOPF_FTW5[23:16]				0x00	R/W
0x819	HOPF_FTW5_3	[7:0]					HOPF_FTW5[31:24]				0x00	R/W
0x81A	HOPF_FTW6_0	[7:0]					HOPF_FTW6[7:0]				0x00	R/W
0x81B	HOPF_FTW6_1	[7:0]					HOPF_FTW6[15:8]				0x00	R/W
0x81C	HOPF_FTW6_2	[7:0]					HOPF_FTW6[23:16]				0x00	R/W
0x81D	HOPF_FTW6_3	[7:0]					HOPF_FTW6[31:24]				0x00	R/W
0x81E	HOPF_FTW7_0	[7:0]					HOPF_FTW7[7:0]				0x00	R/W
0x81F	HOPF_FTW7_1	[7:0]					HOPF_FTW7[15:8]				0x00	R/W
0x820	HOPF_FTW7_2	[7:0]					HOPF_FTW7[23:16]				0x00	R/W
0x821	HOPF_FTW7_3	[7:0]					HOPF_FTW7[31:24]				0x00	R/W
0x822	HOPF_FTW8_0	[7:0]					HOPF_FTW8[7:0]				0x00	R/W
0x823	HOPF_FTW8_1	[7:0]					HOPF_FTW8[15:8]				0x00	R/W
0x824	HOPF_FTW8_2	[7:0]					HOPF_FTW8[23:16]				0x00	R/W
0x825	HOPF_FTW8_3	[7:0]					HOPF_FTW8[31:24]				0x00	R/W
0x826	HOPF_FTW9_0	[7:0]					HOPF_FTW9[7:0]				0x00	R/W
0x827	HOPF_FTW9_1	[7:0]					HOPF_FTW9[15:8]				0x00	R/W
0x828	HOPF_FTW9_2	[7:0]					HOPF_FTW9[23:16]				0x00	R/W
0x829	HOPF_FTW9_3	[7:0]					HOPF_FTW9[31:24]				0x00	R/W
0x82A	HOPF_FTW10_0	[7:0]					HOPF_FTW10[7:0]				0x00	R/W
0x82B	HOPF_FTW10_1	[7:0]					HOPF_FTW10[15:8]				0x00	R/W
0x82C	HOPF_FTW10_2	[7:0]					HOPF_FTW10[23:16]				0x00	R/W
0x82D	HOPF_FTW10_3	[7:0]					HOPF_FTW10[31:24]				0x00	R/W
0x82E	HOPF_FTW11_0	[7:0]					HOPF_FTW11[7:0]				0x00	R/W
0x82F	HOPF_FTW11_1	[7:0]					HOPF_FTW11[15:8]				0x00	R/W
0x830	HOPF_FTW11_2	[7:0]					HOPF_FTW11[23:16]				0x00	R/W
0x831	HOPF_FTW11_3	[7:0]					HOPF_FTW11[31:24]				0x00	R/W
0x832	HOPF_FTW12_0	[7:0]					HOPF_FTW12[7:0]				0x00	R/W
0x833	HOPF_FTW12_1	[7:0]					HOPF_FTW12[15:8]				0x00	R/W
0x834	HOPF_FTW12_2	[7:0]					HOPF_FTW12[23:16]				0x00	R/W
0x835	HOPF_FTW12_3	[7:0]					HOPF_FTW12[31:24]				0x00	R/W
0x836	HOPF_FTW13_0	[7:0]					HOPF_FTW13[7:0]				0x00	R/W
0x837	HOPF_FTW13_1	[7:0]					HOPF_FTW13[15:8]				0x00	R/W
0x838	HOPF_FTW13_2	[7:0]					HOPF_FTW13[23:16]				0x00	R/W
0x839	HOPF_FTW13_3	[7:0]					HOPF_FTW13[31:24]				0x00	R/W
0x83A	HOPF_FTW14_0	[7:0]					HOPF_FTW14[7:0]				0x00	R/W
0x83B	HOPF_FTW14_1	[7:0]					HOPF_FTW14[15:8]				0x00	R/W
0x83C	HOPF_FTW14_2	[7:0]					HOPF_FTW14[23:16]				0x00	R/W
0x83D	HOPF_FTW14_3	[7:0]					HOPF_FTW14[31:24]				0x00	R/W
0x83E	HOPF_FTW15_0	[7:0]					HOPF_FTW15[7:0]				0x00	R/W
0x83F	HOPF_FTW15_1	[7:0]					HOPF_FTW15[15:8]				0x00	R/W
0x840	HOPF_FTW15_2	[7:0]					HOPF_FTW15[23:16]				0x00	R/W
0x841	HOPF_FTW15_3	[7:0]					HOPF_FTW15[31:24]				0x00	R/W
0x842	HOPF_FTW16_0	[7:0]					HOPF_FTW16[7:0]				0x00	R/W
0x843	HOPF_FTW16_1	[7:0]					HOPF_FTW16[15:8]				0x00	R/W
0x844	HOPF_FTW16_2	[7:0]					HOPF_FTW16[23:16]				0x00	R/W
0x845	HOPF_FTW16_3	[7:0]					HOPF_FTW16[31:24]				0x00	R/W
0x846	HOPF_FTW17_0	[7:0]					HOPF_FTW17[7:0]				0x00	R/W
0x847	HOPF_FTW17_1	[7:0]					HOPF_FTW17[15:8]				0x00	R/W
0x848	HOPF_FTW17_2	[7:0]					HOPF_FTW17[23:16]				0x00	R/W
0x849	HOPF_FTW17_3	[7:0]					HOPF_FTW17[31:24]				0x00	R/W
0x84A	HOPF_FTW18_0	[7:0]					HOPF_FTW18[7:0]				0x00	R/W
0x84B	HOPF_FTW18_1	[7:0]					HOPF_FTW18[15:8]				0x00	R/W
0x84C	HOPF_FTW18_2	[7:0]					HOPF_FTW18[23:16]				0x00	R/W
0x84D	HOPF_FTW18_3	[7:0]					HOPF_FTW18[31:24]				0x00	R/W

Reg.	Name	Bits	Bit 7	Bit 6	Bit 5	Bit 4	Bit 3	Bit 2	Bit 1	Bit 0	Reset	RW
0x84E	HOPF_FTW19_0	[7:0]				HOPF_FTW19[7:0]					0x00	R/W
0x84F	HOPF_FTW19_1	[7:0]				HOPF_FTW19[15:8]					0x00	R/W
0x850	HOPF_FTW19_2	[7:0]				HOPF_FTW19[23:16]					0x00	R/W
0x851	HOPF_FTW19_3	[7:0]				HOPF_FTW19[31:24]					0x00	R/W
0x852	HOPF_FTW20_0	[7:0]				HOPF_FTW20[7:0]					0x00	R/W
0x853	HOPF_FTW20_1	[7:0]				HOPF_FTW20[15:8]					0x00	R/W
0x854	HOPF_FTW20_2	[7:0]				HOPF_FTW20[23:16]					0x00	R/W
0x855	HOPF_FTW20_3	[7:0]				HOPF_FTW20[31:24]					0x00	R/W
0x856	HOPF_FTW21_0	[7:0]				HOPF_FTW21[7:0]					0x00	R/W
0x857	HOPF_FTW21_1	[7:0]				HOPF_FTW21[15:8]					0x00	R/W
0x858	HOPF_FTW21_2	[7:0]				HOPF_FTW21[23:16]					0x00	R/W
0x859	HOPF_FTW21_3	[7:0]				HOPF_FTW21[31:24]					0x00	R/W
0x85A	HOPF_FTW22_0	[7:0]				HOPF_FTW22[7:0]					0x00	R/W
0x85B	HOPF_FTW22_1	[7:0]				HOPF_FTW22[15:8]					0x00	R/W
0x85C	HOPF_FTW22_2	[7:0]				HOPF_FTW22[23:16]					0x00	R/W
0x85D	HOPF_FTW22_3	[7:0]				HOPF_FTW22[31:24]					0x00	R/W
0x85E	HOPF_FTW23_0	[7:0]				HOPF_FTW23[7:0]					0x00	R/W
0x85F	HOPF_FTW23_1	[7:0]				HOPF_FTW23[15:8]					0x00	R/W
0x860	HOPF_FTW23_2	[7:0]				HOPF_FTW23[23:16]					0x00	R/W
0x861	HOPF_FTW23_3	[7:0]				HOPF_FTW23[31:24]					0x00	R/W
0x862	HOPF_FTW24_0	[7:0]				HOPF_FTW24[7:0]					0x00	R/W
0x863	HOPF_FTW24_1	[7:0]				HOPF_FTW24[15:8]					0x00	R/W
0x864	HOPF_FTW24_2	[7:0]				HOPF_FTW24[23:16]					0x00	R/W
0x865	HOPF_FTW24_3	[7:0]				HOPF_FTW24[31:24]					0x00	R/W
0x866	HOPF_FTW25_0	[7:0]				HOPF_FTW25[7:0]					0x00	R/W
0x867	HOPF_FTW25_1	[7:0]				HOPF_FTW25[15:8]					0x00	R/W
0x868	HOPF_FTW25_2	[7:0]				HOPF_FTW25[23:16]					0x00	R/W
0x869	HOPF_FTW25_3	[7:0]				HOPF_FTW25[31:24]					0x00	R/W
0x86A	HOPF_FTW26_0	[7:0]				HOPF_FTW26[7:0]					0x00	R/W
0x86B	HOPF_FTW26_1	[7:0]				HOPF_FTW26[15:8]					0x00	R/W
0x86C	HOPF_FTW26_2	[7:0]				HOPF_FTW26[23:16]					0x00	R/W
0x86D	HOPF_FTW26_3	[7:0]				HOPF_FTW26[31:24]					0x00	R/W
0x86E	HOPF_FTW27_0	[7:0]				HOPF_FTW27[7:0]					0x00	R/W
0x86F	HOPF_FTW27_1	[7:0]				HOPF_FTW27[15:8]					0x00	R/W
0x870	HOPF_FTW27_2	[7:0]				HOPF_FTW27[23:16]					0x00	R/W
0x871	HOPF_FTW27_3	[7:0]				HOPF_FTW27[31:24]					0x00	R/W
0x872	HOPF_FTW28_0	[7:0]				HOPF_FTW28[7:0]					0x00	R/W
0x873	HOPF_FTW28_1	[7:0]				HOPF_FTW28[15:8]					0x00	R/W
0x874	HOPF_FTW28_2	[7:0]				HOPF_FTW28[23:16]					0x00	R/W
0x875	HOPF_FTW28_3	[7:0]				HOPF_FTW28[31:24]					0x00	R/W
0x876	HOPF_FTW29_0	[7:0]				HOPF_FTW29[7:0]					0x00	R/W
0x877	HOPF_FTW29_1	[7:0]				HOPF_FTW29[15:8]					0x00	R/W
0x878	HOPF_FTW29_2	[7:0]				HOPF_FTW29[23:16]					0x00	R/W
0x879	HOPF_FTW29_3	[7:0]				HOPF_FTW29[31:24]					0x00	R/W
0x87A	HOPF_FTW30_0	[7:0]				HOPF_FTW30[7:0]					0x00	R/W
0x87B	HOPF_FTW30_1	[7:0]				HOPF_FTW30[15:8]					0x00	R/W
0x87C	HOPF_FTW30_2	[7:0]				HOPF_FTW30[23:16]					0x00	R/W
0x87D	HOPF_FTW30_3	[7:0]				HOPF_FTW30[31:24]					0x00	R/W
0x87E	HOPF_FTW31_0	[7:0]				HOPF_FTW31[7:0]					0x00	R/W
0x87F	HOPF_FTW31_1	[7:0]				HOPF_FTW31[15:8]					0x00	R/W
0x880	HOPF_FTW31_2	[7:0]				HOPF_FTW31[23:16]					0x00	R/W
0x881	HOPF_FTW31_3	[7:0]				HOPF_FTW31[31:24]					0x00	R/W

## REGISTER DETAILS: DAC REGISTER MAP

Table 46. Register Details

Hex. Addr.	Register Name	Bit No.	Bit Name	Settings	Description	Reset	Access
0x000	SPI_INTFCONFA	7	SOFTRESET_M		Soft reset (mirror). Set this to mirror Bit 0.	0x0	R
		6	LSBFIRST_M		LSB first (mirror). Set this to mirror Bit 1.	0x0	R
		5	ADDRINC_M		Address increment (mirror). Set this to mirror Bit 2.	0x0	R
		4	SDOACTIVE_M		SDO active (mirror). Set this to mirror Bit 3.	0x0	R
		3	SDOACTIVE		SDO active. Enables 4-wire SPI bus mode.	0x0	R/W
		2	ADDRINC		Address increment. When set, causes incrementing streaming addresses. Otherwise, descending addresses are generated. 1 Streaming addresses are incremented. 0 Streaming addresses are decremented.	0x0	R/W
		1	LSBFIRST		LSB first. When set, causes input and output data to be oriented as LSB first. If this bit is clear, data is oriented as MSB first. 1 Shift LSB in first. 0 Shift MSB in first.	0x0	R/W
		0	SOFTRESET		Soft reset. This bit automatically clears to 0 after performing a reset operation. Setting this bit initiates a reset. This bit is autoclearing after the soft reset is complete. 1 Pulse the soft reset line. 0 Reset the soft reset line.	0x0	R/W
0x001	SPI_INTFCONFB	7	SINGLEINS		Single instruction. 1 Perform single transfers. 0 Perform multiple transfers.	0x0	R/W
		6	CSSTALL		$\overline{CS}_x$ stalling. 0 Disable $\overline{CS}_x$ stalling. 1 Enable $\overline{CS}_x$ stalling.	0x0	R/W
		[5:3]	Reserved		Reserved.	0x0	R/W
		2	SOFTRESET1		Soft Reset 1. This bit automatically clears to 0 after performing a reset operation. 1 Pulse the Soft Reset 1 line. 0 Pulse the Soft Reset 1 line.	0x0	R/W
		1	SOFTRESET0		Soft Reset 0. This bit automatically clears to 0 after performing a reset operation. 1 Pulse the Soft Reset 0 line. 0 Pulse the Soft Reset 0 line.	0x0	R/W
		0	Reserved		Reserved.	0x0	R

Hex. Addr.	Register Name	Bit No.	Bit Name	Settings	Description	Reset	Access
0x002	SPI_DEVCONF	[7:4]	DEVSTATUS		Device status.	0x0	R/W
		[3:2]	CUSTOPMODE		Customer operating mode.	0x0	R/W
		[1:0]	SYSOPMODE		System operating mode. 0 Normal operation. 1 Low power operation. 2 Medium power standby. 3 Low power sleep.	0x0	R/W
0x003	SPI_CHIPTYPE	[7:0]	CHIP_TYPE		Chip type.	0x0	R
0x004	SPI_PRODIDL	[7:0]	PROD_ID[7:0]		Product ID.	0x0	R
0x005	SPI_PRODIDH	[7:0]	PROD_ID[15:8]		Product ID.	0x0	R
0x006	SPI_CHIPGRADE	[7:4]	PROD_GRADE		Product grade.	0x0	R
		[3:0]	DEV_REVISION		Device revision.	0x0	R
0x020	IRQ_ENABLE	[7:5]	Reserved		Reserved.	0x0	R
		4	EN_SYSREF_JITTER		Enable SYSREF± jitter interrupt. 0 Disable interrupt. 1 Enable interrupt.	0x0	R/W
		3	EN_DATA_READY		Enable JESD204x receiver ready (JRX_DATA_READY) low interrupt. 0 Disable interrupt. 1 Enable interrupt.	0x0	R/W
		2	EN_LANE_FIFO		Enable lane FIFO overflow/underflow interrupt. 0 Disable interrupt. 1 Enable interrupt.	0x0	R/W
		1	EN_PRBSQ		Enable PRBS imaginary error interrupt. 0 Disable interrupt. 1 Enable interrupt.	0x0	R/W
		0	EN_PRBSI		Enable PRBS real error interrupt. 0 Disable interrupt. 1 Enable interrupt.	0x0	R/W
0x024	IRQ_STATUS	[7:5]	Reserved		Reserved.	0x0	R
		4	IRQ_SYSREF_JITTER		SYSREF± jitter is too big. Writing 1 clears the status.	0x0	R/W
		3	IRQ_DATA_READY		JRX_DATA_READY is low. Writing 1 clears the status. 0 No warning. 1 Warning detected.	0x0	R/W
		2	IRQ_LANE_FIFO		Lane FIFO overflow/underflow. Writing 1 clears the status. 0 No warning. 1 Warning detected.	0x0	R/W
		1	IRQ_PRBSQ		PRBS imaginary error. Writing 1 clears the status. 0 No warning. 1 Warning detected.	0x0	R/W
		0	IRQ_PRBSI		PRBS real error. Writing 1 clears the status. 0 No warning. 1 Warning detected.	0x0	R/W
0x031	SYNC_LMFC_DELAY_FRAME	[7:5]	Reserved		Reserved.	0x0	R
		[4:0]	SYNC_LMFC_DELAY_SET_FRM		Desired delay from rising edge of SYSREF± input to rising edge of LMFC in frames.	0x0	R/W



Hex. Addr.	Register Name	Bit No.	Bit Name	Settings	Description	Reset	Access
0x032	SYNC_LMFC_DELAY0	[7:0]	SYNC_LMFC_DELAY_SET[7:0]		Desired delay from rising edge of SYSREF± input to rising edge of LMFC in clock units.	0x0	R/W
0x033	SYNC_LMFC_DELAY1	[7:4]	Reserved		Reserved.	0x0	R
		[3:0]	SYNC_LMFC_DELAY_SET[11:8]		Desired delay from rising edge of SYSREF± input to rising edge of LMFC in clock units.	0x0	R/W
0x034	SYNC_LMFC_STAT0	[7:0]	SYNC_LMFC_DELAY_STAT[7:0]		Measured delay from rising edge of SYSREF± input to rising edge of LMFC in device clock units (2 LSBs are always zero). A write to SYNC_LMFC_STATx or SYSREF_PHASEx saves the data for readback.	0x0	R/W
0x035	SYNC_LMFC_STAT1	[7:4]	Reserved		Reserved.	0x0	R
		[3:0]	SYNC_LMFC_DELAY_STAT[11:8]		Measured delay from rising edge of SYSREF± input to rising edge of LMFC in device clock units (2 LSBs are always zero). A write to SYNC_LMFC_STATx or SYSREF_PHASEx saves the data for readback.	0x0	R/W
0x036	SYSREF_COUNT	[7:0]	SYSREF_COUNT		Count of SYSREF± signals received. A write resets the count. A write to SYNC_LMFC_STATx or SYSREF_PHASEx saves the data for readback.	0x0	R/W
0x037	SYSREF_PHASE0	[7:0]	SYSREF_PHASE[7:0]		Phase of measured SYSREF± event. Thermometer encoded. A write to SYNC_LMFC_STATx or SYSREF_PHASEx saves the data for readback.	0x0	R/W
0x038	SYSREF_PHASE1	[7:4]	Reserved		Reserved.	0x0	R
		[3:0]	SYSREF_PHASE[11:8]		Phase of measured SYSREF± event. Thermometer encoded. A write to SYNC_LMFC_STATx or SYSREF_PHASEx saves the data for readback.	0x0	R/W
0x039	SYSREF_JITTER_WINDOW	[7:6]	Reserved		Reserved.	0x0	R
		[5:0]	SYSREF_JITTER_WINDOW		Amount of jitter allowed on the SYSREF± input. SYSREF± jitter variations bigger than this triggers an interrupt. Units are in device clock cycles. The bottom two bits are ignored.	0x0	R/W
0x03A	SYNC_CTRL	[7:2]	Reserved		Reserved.	0x0	R
		[1:0]	SYNC_MODE		Synchronization mode. 00 Do not perform synchronization; monitor SYSREF± to LMFC delay only. 01 Perform continuous synchronization of LMFC on every SYSREF±. 10 Perform a single synchronization on the next SYSREF±, then switch to monitor mode.	0x0	R/W

Hex. Addr.	Register Name	Bit No.	Bit Name	Settings	Description	Reset	Access
0x03F	TX_ENABLE	7	SPI_DATAPATH_POST		SPI control of the data at the output of the datapath. 0 Disable or zero the data from the datapath into the DAC. 1 Use the data from the datapath to drive the DAC.	0x1	R/W
		6	SPI_DATAPATH_PRE		SPI control of the data at the input of the datapath. 0 Disable or zero the data feeding into the datapath. 1 Use the data from the JESD204B lanes to drive into the datapath.	0x1	R/W
		[5:4]	Reserved		Reserved.	0x0	R
		3	TXEN_NCO_RESET		Allows TX_ENABLE to control the DDS NCO reset. 0 Use the SPI (HOPF_MODE bits to control the DDS NCO reset. 1 Use the TX_ENABLE pin to control the DDS NCO reset.	0x0	R/W
		2	TXEN_DATAPATH_POST		Allows TX_ENABLE to control the data at the output of the datapath. 0 Use the SPI (Bit SPI_DATAPATH_POST) for control. 1 Use the TX_ENABLE pin for control.	0x0	R/W
		1	TXEN_DATAPATH_PRE		Allows TX_ENABLE to control the data at the input of the datapath. 0 Use the SPI (Bit SPI_DATAPATH_PRE) for control. 1 Use the TX_ENABLE pin for control.	0x0	R/W
		0	TXEN_DAC_FSC		Allows TX_ENABLE to control the DAC full-scale current. 0 Use SPI Register ANA_FSCO and ANA_FSC1 for control. 1 Use the TX_ENABLE pin for control.	0x0	R/W
0x040	ANA_DAC_BIAS_PD	[7:2]	Reserved		Reserved.	0x0	R
		1	ANA_DAC_BIAS_PD1		Powers down the DAC core bias circuits. A 1 powers down the DAC core bias circuits.	0x1	R/W
		0	ANA_DAC_BIAS_PDO		Powers down the DAC core bias circuits. A 1 powers down the DAC core bias circuits.	0x1	R/W
0x041	ANA_FSCO	[7:2]	Reserved		Reserved.	0x0	R
		[1:0]	ANA_FULL_SCALE_CURRENT		DAC full-scale current. Analog full-scale current adjustment ( $I_{OUTFS}$ ). $I_{OUTFS} = 32 \text{ mA} \times (ANA\_FULL\_SCALE\_CURRENT / 1023) + 8 \text{ mA}$	0x3	R/W
0x042	ANA_FSC1	[7:0]	ANA_FULL_SCALE_CURRENT[9:2]		DAC full-scale current. Analog full-scale current adjustment ( $I_{OUTFS}$ ). $I_{OUTFS} = 32 \text{ mA} \times (ANA\_FULL\_SCALE\_CURRENT / 1023) + 8 \text{ mA}$	0xFF	R/W

Hex. Addr.	Register Name	Bit No.	Bit Name	Settings	Description	Reset	Access	
0x07F	CLK_PHASE_TUNE	[7:6]	Reserved		Reserved.	0x0	R	
		[5:0]	CLK_PHASE_TUNE		Fine tuning of the clock input phase balance. Adds capacitance to the CLK+ or the CLK- input to phase shift the differential input at CLK±. The register is coded as signed binary. Added nominal capacitance = CLK_PHASE_TUNE × 20 fF	0x0	R/W	
				<b>Added Nominal Capacitance</b>				
				<b>At CLK+</b>	<b>At CLK-</b>			
		0x0	0	0				
		0x1	20	0				
		0x2	40	0				
		...	...	...				
		0x1F	620	0				
		0x20	0	0				
0x21	0	20						
0x22	0	40						
...	...	...						
0x3F	0	620						
0x080	CLK_PD	[7:1]	Reserved		Reserved.	0x0	R	
		0	DACCLK_PD		Device clock power-down. Powers down the device input clock circuitry. 0 Power up. 1 Power down.	0x1	R/W	
0x082	CLK_DUTY	7	CLK_DUTY_EN		Enable duty cycle control.	0x1	R/W	
		6	CLK_DUTY_OFFSET_EN		Enable duty cycle offset.	0x0	R/W	
		5	CLK_DUTY_BOOST_EN		Enable duty cycle range boost. Extends range to ±5% at cost of 1 dB to 2 dB worse phase noise.	0x0	R/W	
		[4:0]	CLK_DUTY_PRG		Program the duty cycle offset. 5-bit signed magnitude field, with the MSB as the sign bit and the four LSBs as the magnitude from 0 to 15. A larger magnitude skews duty cycle to a greater amount. Range is ±3%.	0x0	R/W	
0x083	CLK_CRS_CTRL	7	CLK_CRS_EN		Enable clock cross control adjustment.	0x1	R/W	
		[6:4]	Reserved		Reserved.	0x0	R	
		[3:0]	CLK_CRS_ADJ		Program the clock crossing point.	0x0	R/W	
0x084	PLL_REF_CLK_PD	[7:6]	Reserved		Reserved.	0x0	R	
		[5:4]	PLL_REF_CLK_RATE		PLL reference clock rate multiplier. 00 Normal rate (1×) PLL reference clock. 01 Double rate (2×) PLL reference clock. 10 Quadruple rate (4×) PLL reference clock. 11 Disable the PLL reference clock.	0x0	R/W	
		[3:1]	Reserved		Reserved.	0x0	R	

Hex. Addr.	Register Name	Bit No.	Bit Name	Settings	Description	Reset	Access
		0	PLL_REF_CLK_PD		PLL reference clock power-down. 0 Enable the PLL reference clock. 1 Power down the PLL reference clock.	0x0	R/W
0x088	SYSREF_CTRL0	[7:4]	Reserved		Reserved.	0x0	R
		3	HYS_ON		SYSREF± hysteresis enable. This bit enables the programmable hysteresis control for the SYSREF± receiver.	0x0	R/W
		2	SYSREF_RISE		Use SYSREF± rising edge.	0x0	R/W
		[1:0]	HYS_CNTRL[9:8]		Controls the amount of hysteresis in the SYSREF± receiver. Each of the 10 bits adds 10 mV of differential hysteresis to the receiver input.	0x0	R/W
0x089	SYSREF_CTRL1	[7:0]	HYS_CNTRL[7:0]		Controls the amount of hysteresis in the SYSREF± receiver. Each of the 10 bits adds 10 mV of differential hysteresis to the receiver input.	0x0	R/W
0x090	DLL_PD	[7:5]	Reserved		Reserved.	0x0	R
		4	DLL_FINE_DC_EN		Fine delay line duty cycle correction enable.	0x1	R/W
		3	DLL_FINE_XC_EN		Fine delay line cross control enable.	0x1	R/W
		2	DLL_COARSE_DC_EN		Coarse delay line duty cycle correction enable.	0x1	R/W
		1	DLL_COARSE_XC_EN		Coarse delay line cross control enable.	0x1	R/W
		0	DLL_CLK_PD		Powers down DLL and digital clock generator. 0 Power up DLL controller. 1 Power down DLL controller.	0x1	R/W
0x091	DLL_CTRL	7	DLL_TRACK_ERR		Track error behavior. 0 Continue on error. 1 Restart on error.	0x1	R/W
		6	DLL_SEARCH_ERR		Search error behavior. 0 Stop on error. 1 Retry on error.	0x1	R/W
		5	DLL_SLOPE		Desired slope. 0 Negative slope. 1 Positive slope.	0x1	R/W
		[4:3]	DLL_SEARCH		Search direction. 00 Search down from initial point only. 01 Search up from initial point only. 10 Search up and down from initial point.	0x2	R/W
		[2:1]	DLL_MODE		Controller mode. 00 Search then track. 01 Track only. 10 Search only.	0x0	R/W

Hex. Addr.	Register Name	Bit No.	Bit Name	Settings	Description	Reset	Access
		0	DLL_ENABLE		Controller enable. 0 Disable DLL controller: use static SPI settings. 1 Enable DLL controller: use controller with feedback loop.	0x0	R/W
0x092	DLL_STATUS	[7:3]	Reserved		Reserved.	0x0	R
		2	DLL_FAIL		The device clock DLL failed to lock.	0x0	R
		1	DLL_LOST		The device clock DLL has lost lock.	0x0	R/W
		0	DLL_LOCKED		The device clock DLL has achieved lock.	0x0	R
0x093	DLL_GB	[7:4]	Reserved		Reserved.	0x0	R
		[3:0]	DLL_GUARD		Search guard band.	0x0	R/W
0x094	DLL_COARSE	[7:6]	Reserved		Reserved.	0x0	R
		[5:0]	DLL_COARSE		Coarse delay line setpoint.	0x0	R/W
0x095	DLL_FINE	[7:0]	DLL_FINE		Fine delay line setpoint.	0x80	R/W
0x096	DLL_PHASE	[7:5]	Reserved		Reserved.	0x0	R
		[4:0]	DLL_PHS		Desired phase. 0 Minimum allowed phase. 16 Maximum allowed phase.	0x8	R/W
0x097	DLL_BW	[7:5]	Reserved		Reserved.	0x0	R
		[4:2]	DLL_FILT_BW		Phase measurement filter bandwidth.	0x0	R/W
		[1:0]	DLL_WEIGHT		Tracking speed.	0x0	R/W
0x098	DLL_READ	[7:1]	Reserved		Reserved.	0x0	R
		0	DLL_READ		Read request: 0 to 1 transition updates the coarse, fine, and phase readback values.	0x0	R/W
0x099	DLL_COARSE_RB	[7:6]	Reserved		Reserved.	0x0	R
		[5:0]	DLL_COARSE_RB		Coarse delay line readback.	0x0	R
0x09A	DLL_FINE_RB	[7:0]	DLL_FINE_RB		Fine delay line readback.	0x0	R
0x09B	DLL_PHASE_RB	[7:5]	Reserved		Reserved.	0x0	R
		[4:0]	DLL_PHS_RB		Phase readback.	0x0	R
0x09D	DIG_CLK_INVERT	[7:3]	Reserved		Reserved.	0x0	R
		2	INV_DIG_CLK		Invert digital clock from DLL. 0 Normal polarity. 1 Inverted polarity.	0x0	R/W
		1	DIG_CLK_DC_EN		Digital clock duty cycle correction enable.	0x1	R/W
		0	DIG_CLK_XC_EN		Digital clock cross control enable.	0x1	R/W
0x0A0	DLL_CLK_DEBUG	7	DLL_TEST_EN		DLL clock output test enable.	0x0	R/W
		[6:2]	Reserved		Reserved.	0x0	R
		[1:0]	DLL_TEST_DIV		DLL clock output divide.	0x0	R/W
0x110	INTERP_MODE	[7:4]	JESD_LANES		Number of JESD204B lanes. For proper operation of the JESD204B data link, this signal must only be programmed while the QBD is held in soft reset (Register 0x475, Bit 3), and must not be changed during normal operation.	0x8	R/W

Hex. Addr.	Register Name	Bit No.	Bit Name	Settings	Description	Reset	Access
		[3:0]	INTERP_MODE		Interpolation mode. For proper operation of the JESD204B data link, this signal must only be programmed while the QBD is held in soft reset (Register 0x475, Bit 3), and must not be changed during normal operation.  0000 1× (bypass). 0001 2×. 0010 3×. 0011 4×. 0100 6×. 0101 8×. 0110 12×. 0111 16×. 1000 24×.	0x1	R/W
0x111	DATAPATH_CFG	7	INVSINC_EN		Inverse sinc filter enable. 0 Disable inverse sinc filter. 1 Enable inverse sinc filter.	0x0	R/W
		6	NCO_EN		Modulation enable. 0 Disable NCO. 1 Enable NCO.	0x0	R/W
		5	Reserved		Reserved.	0x0	R
		4	FILT_BW		Datapath filter bandwidth. 0 Filter bandwidth is 80%. 1 Filter bandwidth is 90%.	0x0	R/W
		3	Reserved		Reserved.	0x0	R
		2	MODULUS_EN		Modulus DDS enable. 0 Disable modulus DDS. 1 Enable modulus DDS.	0x0	R/W
		1	SEL_SIDE BAND		Selects upper or lower sideband from modulation result. 0 Use upper sideband. 1 Use lower sideband = spectral flip.	0x0	R/W
		0	FIR85_FILT_EN		FIR85 filter enable.	0x0	R/W
0x113	FTW_UPDATE	7	Reserved		Reserved.	0x0	R
		[6:4]	FTW_REQ_MODE		Frequency tuning word (FTW) automatic update mode.  000 No automatic requests are generated when the FTW registers are written. 001 Automatically generate FTW_LOAD_REQ after FTW0 is written. 010 Automatically generate FTW_LOAD_REQ after FTW1 is written. 011 Automatically generate FTW_LOAD_REQ after FTW2 is written. 100 Automatically generate FTW_LOAD_REQ after FTW3 is written. 101 Automatically generate FTW_LOAD_REQ after FTW4 is written.	0x0	R/W

Hex. Addr.	Register Name	Bit No.	Bit Name	Settings	Description	Reset	Access
				110	Automatically generate FTW_LOAD_REQ after FTW5 is written.		
		3	Reserved		Reserved.	0x0	R
		2	FTW_LOAD_SYSREF		FTW load and reset from rising edge of SYSREF±.	0x0	R/W
		1	FTW_LOAD_ACK		Frequency tuning word update acknowledge.	0x0	R
				0	FTW is not loaded.		
				1	FTW is loaded.		
		0	FTW_LOAD_REQ		Frequency tuning word update request from SPI.	0x0	R/W
				0	Clear FTW_LOAD_ACK.		
				1	0 to 1 transition loads the FTW.		
0x114	FTW0	[7:0]	FTW[7:0]		NCO frequency tuning word. This is X in the equation $f_{OUT} = f_{CLK} \times (M/N) = f_{CLK} \times ((X + A/B)/2^{48})$ .	0x0	R/W
0x115	FTW1	[7:0]	FTW[15:8]		NCO frequency tuning word. This is X in the equation $f_{OUT} = f_{CLK} \times (M/N) = f_{CLK} \times ((X + A/B)/2^{48})$ .	0x0	R/W
0x116	FTW2	[7:0]	FTW[23:16]		NCO frequency tuning word. This is X in the equation $f_{OUT} = f_{CLK} \times (M/N) = f_{CLK} \times ((X + A/B)/2^{48})$ .	0x0	R/W
0x117	FTW3	[7:0]	FTW[31:24]		NCO frequency tuning word. This is X in the equation $f_{OUT} = f_{CLK} \times (M/N) = f_{CLK} \times ((X + A/B)/2^{48})$ .	0x0	R/W
0x118	FTW4	[7:0]	FTW[39:32]		NCO frequency tuning word. This is X in the equation $f_{OUT} = f_{CLK} \times (M/N) = f_{CLK} \times ((X + A/B)/2^{48})$ .	0x0	R/W
0x119	FTW5	[7:0]	FTW[47:40]		NCO frequency tuning word. This is X in the equation $f_{OUT} = f_{CLK} \times (M/N) = f_{CLK} \times ((X + A/B)/2^{48})$ .	0x0	R/W
0x11C	PHASE_OFFSET0	[7:0]	NCO_PHASE_OFFSET[7:0]		NCO phase offset.	0x0	R/W
0x11D	PHASE_OFFSET1	[7:0]	NCO_PHASE_OFFSET[15:8]		NCO phase offset.	0x0	R/W
0x124	ACC_MODULUS0	[7:0]	ACC_MODULUS[7:0]		DDS modulus. This is B in the equation $f_{OUT} = f_{CLK} \times (M/N) = f_{CLK} \times ((X + A/B)/2^{48})$ . This modulus value is used for all NCO FTWs.	0x0	R/W
0x125	ACC_MODULUS1	[7:0]	ACC_MODULUS[15:8]		DDS modulus. This is B in the equation $f_{OUT} = f_{CLK} \times (M/N) = f_{CLK} \times ((X + A/B)/2^{48})$ . This modulus value is used for all NCO FTWs.	0x0	R/W
0x126	ACC_MODULUS2	[7:0]	ACC_MODULUS[23:16]		DDS modulus. This is B in the equation $f_{OUT} = f_{CLK} \times (M/N) = f_{CLK} \times ((X + A/B)/2^{48})$ . This modulus value is used for all NCO FTWs.	0x0	R/W
0x127	ACC_MODULUS3	[7:0]	ACC_MODULUS[31:24]		DDS modulus. This is B in the equation $f_{OUT} = f_{CLK} \times (M/N) = f_{CLK} \times ((X + A/B)/2^{48})$ . This modulus value is used for all NCO FTWs.	0x0	R/W

Hex. Addr.	Register Name	Bit No.	Bit Name	Settings	Description	Reset	Access
0x128	ACC_MODULUS4	[7:0]	ACC_MODULUS[39:32]		DDS modulus. This is B in the equation $f_{OUT} = f_{CLK} \times (M/N) = f_{CLK} \times ((X + A/B)/2^{48})$ . This modulus value is used for all NCO FTWs.	0x0	R/W
0x129	ACC_MODULUS5	[7:0]	ACC_MODULUS[47:40]		DDS modulus. This is B in the equation $f_{OUT} = f_{CLK} \times (M/N) = f_{CLK} \times ((X + A/B)/2^{48})$ . This modulus value is used for all NCO FTWs.	0x0	R/W
0x12A	ACC_DELTA0	[7:0]	ACC_DELTA[7:0]		DDS delta. This is A in the equation $f_{OUT} = f_{CLK} \times (M/N) = f_{CLK} \times ((X + A/B)/2^{48})$ . This modulus value is used for all NCO FTWs. Note this delta value is used for all NCO FTWs.	0x0	R/W
0x12B	ACC_DELTA1	[7:0]	ACC_DELTA[15:8]		DDS delta. This is A in the equation $f_{OUT} = f_{CLK} \times (M/N) = f_{CLK} \times ((X + A/B)/2^{48})$ . This modulus value is used for all NCO FTWs. Note this delta value is used for all NCO FTWs.	0x0	R/W
0x12C	ACC_DELTA2	[7:0]	ACC_DELTA[23:16]		DDS delta. This is A in the equation $f_{OUT} = f_{CLK} \times (M/N) = f_{CLK} \times ((X + A/B)/2^{48})$ . Note this modulus value is used for all NCO FTWs. Note this delta value is used for all NCO FTWs.	0x0	R/W
0x12D	ACC_DELTA3	[7:0]	ACC_DELTA[31:24]		DDS delta. This is A in the equation $f_{OUT} = f_{CLK} \times (M/N) = f_{CLK} \times ((X + A/B)/2^{48})$ . This delta value is used for all NCO FTWs.	0x0	R/W
0x12E	ACC_DELTA4	[7:0]	ACC_DELTA[39:32]		DDS Delta. This is A in the equation $f_{OUT} = f_{CLK} \times (M/N) = f_{CLK} \times ((X + A/B)/2^{48})$ . This modulus value is used for all NCO FTWs. Note this delta value is used for all NCO FTWs.	0x0	R/W
0x12F	ACC_DELTA5	[7:0]	ACC_DELTA[47:40]		DDS delta. This is A in the equation $f_{OUT} = f_{CLK} \times (M/N) = f_{CLK} \times ((X + A/B)/2^{48})$ . This modulus value is used for all NCO FTWs. Note this delta value is used for all NCO FTWs.	0x0	R/W
0x132	TEMP_SENS_LSB	[7:0]	TEMP_SENS_OUT[7:0]		Output of the temperature sensor ADC.	0x0	R
0x133	TEMP_SENS_MSB	[7:0]	TEMP_SENS_OUT[15:8]		Output of the temperature sensor ADC.	0x0	R
0x134	TEMP_SENS_UPDATE	[7:1]	Reserved		Reserved.	0x0	R
		0	TEMP_SENS_UPDATE		Set to 1 to update the temperature sensor reading with a new value.	0x0	R/W
0x135	TEMP_SENS_CTRL	7	TEMP_SENS_FAST		A 1 sets the temperature sensor digital filter bandwidth wider for faster settling time.	0x0	R/W
		[6:1]	Reserved		Reserved.	0x10	R/W
		0	TEMP_SENS_ENABLE		Set to 1 to enable the temperature sensor.	0x0	R/W



Hex. Addr.	Register Name	Bit No.	Bit Name	Settings	Description	Reset	Access
0x14B	PRBS	7	PRBS_GOOD_Q		Good data indicator, imaginary channel. 0 Incorrect sequence detected. 1 Correct PRBS sequence detected.	0x0	R
		6	PRBS_GOOD_I		Good data indicator, real channel. 0 Incorrect sequence detected. 1 Correct PRBS sequence detected.	0x0	R
		5	Reserved		Reserved.	0x0	R
		4	PRBS_INV_Q		Data inversion, imaginary channel. 0 Expect normal data. 1 Expect inverted data.	0x1	R/W
		3	PRBS_INV_I		Data inversion, real channel. 0 Expect normal data. 1 Expect inverted data.	0x0	R/W
		2	PRBS_MODE		Polynomial select. 0 7-bit: $x^7 + x^6 + 1$ . 1 15-bit: $x^{15} + x^{14} + 1$ .	0x0	R/W
		1	PRBS_RESET		Reset error counters. 0 Normal operation. 1 Reset counters.	0x0	R/W
		0	PRBS_EN		Enable PRBS checker. 0 Disable. 1 Enable.	0x0	R/W
0x14C	PRBS_ERROR_I	[7:0]	PRBS_COUNT_I		Error count value real channel.	0x0	R
0x14D	PRBS_ERROR_Q	[7:0]	PRBS_COUNT_Q		Error count value imaginary channel.	0x0	R
0x14E	TEST_DC_DATA1	[7:0]	DC_TEST_DATA[15:8]		DC test data.	0x0	R/W
0x14F	TEST_DC_DATA0	[7:0]	DC_TEST_DATA[7:0]		DC test data.	0x0	R/W
0x150	DIG_TEST	[7:2]	Reserved		Reserved.	0x0	R
		1	DC_TEST_EN		DC data test mode enable. 1 DC test mode enable. 0 DC test mode disable.	0x0	R/W
		0	Reserved		Reserved.	0x0	R/W
0x151	DECODE_CTRL	[7:3]	Reserved		Reserved.	0x0	R/W
		2	Shuffle		Shuffle mode. Enables shuffle mode for improved spurious performance. 0 Disable MSB shuffling (use thermometer encoding). 1 Enable MSB shuffling.	0x0	R/W
		[1:0]	Reserved		Reserved.	0x0	R/W
0x152	DECODE_MODE	[7:2]	Reserved		Reserved.	0x0	R
		[1:0]	DECODE_MODE		Decode mode. 00 NRZ mode (first Nyquist). 01 Mix mode (second Nyquist). 10 Return to zero. 11 Reserved.	0x0	R/W
		[7:4]	Reserved		Reserved.	0x0	R
0x1DF	SPI_STRENGTH	[3:0]	SPIDRV		Slew and drive strength for CMOS SPI outputs. Slew = Bits[1:0], drive = Bits[3:2].	0xF	R/W

Hex. Addr.	Register Name	Bit No.	Bit Name	Settings	Description	Reset	Access
0x200	MASTER_PD	[7:1]	Reserved		Reserved.	0x0	R
		0	SPI_PD_MASTER		Powers down the entire JESD204B Rx analog (all eight channels and bias).	0x1	R/W
0x201	PHY_PD	[7:0]	SPI_PD_PHY		SPI override to power down the individual PHYs. Bit 0 controls SERDIN0± PHY. Bit 1 controls SERDIN1± PHY. Bit 2 controls SERDIN2± PHY. Bit 3 controls SERDIN3± PHY. Bit 4 controls SERDIN4± PHY. Bit 5 controls SERDIN5± PHY. Bit 6 controls SERDIN6± PHY. Bit 7 controls SERDIN7± PHY.	0x0	R/W
0x203	GENERIC_PD	[7:2]	Reserved		Reserved.	0x0	R
		1	SPI_SYNC1_PD		Powers down LVDS buffer for the sync request signal, SYNCOUT±.	0x0	R/W
		0	Reserved		Reserved.	0x0	R/W
0x206	CDR_RESET	[7:1]	Reserved		Reserved.	0x0	R
		0	SPI_CDR_RESET		Resets the digital control logic for all PHYs. 0 CDR logic is reset. 1 CDR logic is operational.	0x1	R/W
0x230	CDR_OPERATING_MODE_REG_0	[7:6]	Reserved		Reserved.	0x0	R/W
		5	SPI_ENHALFRATE		Enables half rate CDR operation, must be enabled for data rates > 6 Gbps. 0 Disables CDR half rate operation, data rate ≤ 6 Gbps. 1 Enables CDR half rate operation, data rate > 6 Gbps.	0x1	R/W
		[4:3]	Reserved		Reserved.	0x1	R/W
		[2:1]	SPI_DIVISION_RATE		Enables oversampling of the input data. 00 No division. Data rate > 3 Gbps. 01 Division by 2. 1.5 Gbps < data rate ≤ 3 Gbps. 10 Division by 4. 750 Mbps < data rate ≤ 1.5 Gbps.	0x0	R/W
		0	Reserved		Reserved.	0x0	R/W
0x250	EQ_CONFIG_PHY_0_1	[7:4]	SPI_EQ_CONFIG1		Controls equalizer boost level. 0000 Manual mode (SPI configured values used). 0001 Boost level = 1. 0010 Boost level = 2. 0011 Boost level = 3. 0100 Boost level = 4. 0101 Boost level = 5. 0110 Boost level = 6. 0111 Boost level = 7. 1000 Boost level = 8. 1001 Boost level = 9. 1010 Boost level = 10. 1011 Boost level = 11. 1100 Boost level = 12.	0x8	R/W

Hex. Addr.	Register Name	Bit No.	Bit Name	Settings	Description	Reset	Access
				1101	Boost level = 13.		
				1110	Boost level = 14.		
				1111	Boost level = 15.		
		[3:0]	SPI_EQ_CONFIG0	0000	Controls equalizer boost level. Manual mode (SPI configured values used).	0x8	R/W
				0001	Boost level = 1.		
				0010	Boost level = 2.		
				0011	Boost level = 3.		
				0100	Boost level = 4.		
				0101	Boost level = 5.		
				0110	Boost level = 6.		
				0111	Boost level = 7.		
				1000	Boost level = 8.		
				1001	Boost level = 9.		
				1010	Boost level = 10.		
				1011	Boost level = 11.		
				1100	Boost level = 12.		
				1101	Boost level = 13.		
				1110	Boost level = 14.		
				1111	Boost level = 15.		
0x251	EQ_CONFIG_PHY_2_3	[7:4]	SPI_EQ_CONFIG3	0000	Controls equalizer boost level. Manual mode (SPI configured values used).	0x8	R/W
				0001	Boost level = 1.		
				0010	Boost level = 2.		
				0011	Boost level = 3.		
				0100	Boost level = 4.		
				0101	Boost level = 5.		
				0110	Boost level = 6.		
				0111	Boost level = 7.		
				1000	Boost level = 8.		
				1001	Boost level = 9.		
				1010	Boost level = 10.		
				1011	Boost level = 11.		
				1100	Boost level = 12.		
				1101	Boost level = 13.		
				1110	Boost level = 14.		
				1111	Boost level = 15.		
		[3:0]	SPI_EQ_CONFIG2	0000	Controls equalizer boost level. Manual mode (SPI configured values used).	0x8	R/W
				0001	Boost level = 1.		
				0010	Boost level = 2.		
				0011	Boost level = 3.		
				0100	Boost level = 4.		
				0101	Boost level = 5.		
				0110	Boost level = 6.		
				0111	Boost level = 7.		
				1000	Boost level = 8.		
				1001	Boost level = 9.		
				1010	Boost level = 10.		
				1011	Boost level = 11.		
				1100	Boost level = 12.		

Hex. Addr.	Register Name	Bit No.	Bit Name	Settings	Description	Reset	Access
				1101	Boost Level = 13.		
				1110	Boost level = 14.		
				1111	Boost level = 15.		
0x252	EQ_CONFIG_PHY_4_5	[7:4]	SPI_EQ_CONFIG5		Controls equalizer boost level.	0x8	R/W
				0000	Manual mode (SPI configured values used).		
				0001	Boost level = 1.		
				0010	Boost level = 2.		
				0011	Boost level = 3.		
				0100	Boost level = 4.		
				0101	Boost level = 5.		
				0110	Boost level = 6.		
				0111	Boost level = 7.		
				1000	Boost level = 8.		
				1001	Boost level = 9.		
				1010	Boost level = 10.		
				1011	Boost level = 11.		
				1100	Boost level = 12.		
				1101	Boost level = 13.		
				1110	Boost level = 14.		
				1111	Boost level = 15.		
		[3:0]	SPI_EQ_CONFIG4		Controls equalizer boost level.	0x8	R/W
				0000	Manual mode (SPI configured values used).		
				0001	Boost level = 1.		
				0010	Boost level = 2.		
				0011	Boost level = 3.		
				0100	Boost level = 4.		
				0101	Boost level = 5.		
				0110	Boost level = 6.		
				0111	Boost level = 7.		
				1000	Boost level = 8.		
				1001	Boost level = 9.		
				1010	Boost level = 10.		
				1011	Boost level = 11.		
				1100	Boost level = 12.		
				1101	Boost level = 13.		
				1110	Boost level = 14.		
				1111	Boost level = 15.		
0x253	EQ_CONFIG_PHY_6_7	[7:4]	SPI_EQ_CONFIG7		Controls equalizer boost level.	0x8	R/W
				0000	Manual mode (SPI configured values used).		
				0001	Boost level = 1.		
				0010	Boost level = 2.		
				0011	Boost level = 3.		
				0100	Boost level = 4.		
				0101	Boost level = 5.		
				0110	Boost level = 6.		
				0111	Boost level = 7.		
				1000	Boost level = 8.		
				1001	Boost level = 9.		
				1010	Boost level = 10.		
				1011	Boost level = 11.		
				1100	Boost level = 12.		

Hex. Addr.	Register Name	Bit No.	Bit Name	Settings	Description	Reset	Access
				1101	Boost level = 13.		
				1110	Boost level = 14.		
				1111	Boost level = 15.		
		[3:0]	SPI_EQ_CONFIG6		Controls equalizer boost level.	0x8	R/W
				0000	Manual mode (SPI configured values used).		
				0001	Boost level = 1.		
				0010	Boost level = 2.		
				0011	Boost level = 3.		
				0100	Boost level = 4.		
				0101	Boost level = 5.		
				0110	Boost level = 6.		
				0111	Boost level = 7.		
				1000	Boost level = 8.		
				1001	Boost level = 9.		
				1010	Boost level = 10.		
				1011	Boost level = 11.		
				1100	Boost level = 12.		
				1101	Boost level = 13.		
				1110	Boost level = 14.		
				1111	Boost level = 15.		
0x268	EQ_BIAS_REG	[7:6]	EQ_POWER_MODE		Controls the equalizer power mode/insertion loss capability.	0x1	R/W
				00	Normal mode.		
				01	Low power mode.		
		[5:0]	Reserved		Reserved.	0x4	R/W
0x280	SYNTH_ENABLE_CNTRL	[7:3]	Reserved		Reserved.	0x0	R
		2	SPI_RECAL_SYNTH		Set this bit high to rerun all of the SERDES PLL calibration routines. Set this bit low again to allow additional recalibrations. Rising edge causes the calibration.	0x0	R/W
		1	Reserved		Reserved.	0x0	R/W
		0	SPI_ENABLE_SYNTH		Enable the SERDES PLL. Setting this bit turns on all currents and proceeds to calibrate the PLL. Make sure reference clock and division ratios are correct before enabling this bit.	0x0	R/W
0x281	PLL_STATUS	[7:6]	Reserved		Reserved.	0x0	R
		5	SPI_CP_OVER_RANGE_HIGH_RB		If set, the SERDES PLL CP output is above the valid operating range.	0x0	R
				0	Charge pump output is within operating range.		
				1	Charge pump output is above operating range.		
		4	SPI_CP_OVER_RANGE_LOW_RB		If set, the SERDES PLL CP output is below the valid operating range.	0x0	R
				0	Charge pump output is within operating range.		
				1	Charge pump output is below operating range.		

Hex. Addr.	Register Name	Bit No.	Bit Name	Settings	Description	Reset	Access
		3	SPI_CP_CAL_VALID_RB		This bit tells the user if the charge pump calibration has completed and is valid. 0 Charge pump calibration is not valid. 1 Charge pump calibration is valid.	0x0	R
		[2:1]	Reserved		Reserved.	0x0	R
		0	SPI_PLL_LOCK_RB		If set, the SERDES synthesizer is locked. 0 PLL is not locked. 1 PLL is locked.	0x0	R
0x289	REF_CLK_DIVIDER_LDO	[7:2]	Reserved		Reserved.	0x0	R
		[1:0]	SERDES_PLL_DIV_FACTOR		SERDES PLL reference clock division factor. This field controls the division of the SERDES PLL reference clock before it is fed into the SERDES PLL PFD. It must be set so that $f_{REF}/\text{division factor}$ is between 35 MHz and 80 MHz. 00 Divide by 4 for lane rate between 6 Gbps and 12.5 Gbps. 01 Divide by 2 for lane rate between 3 Gbps and 6 Gbps. 10 Divide by 1 for lane rate between 1.5 Gbps and 3 Gbps.	0x0	R/W
0x2A7	TERM_BLK1_CTRLREG0	[7:1]	Reserved		Reserved.	0x0	R
		0	SPI_I_TUNE_R_CAL_TERMBLK1		Rising edge of this bit starts a termination calibration routine.	0x0	R/W
0x2A8	TERM_BLK1_CTRLREG1	[7:0]	SPI_I_SERIALIZER_RTRIM_TERMBLK1		SPI override for termination value for PHY 0, PHY 1, PHY 6, and PHY 7. Value options are as follows: XXX0XXXX Automatically calibrate termination value. XXX1000X Force 000 as termination value. XXX1001X Force 001 as termination value. XXX1010X Force 010 as termination value. XXX1011X Force 011 as termination value. XXX1100X Force 100 as termination value. XXX1101X Force 101 as termination value. XXX1110X Force 110 as termination value. XXX1111X Force 111 as termination value. XXX1000X Force 000 as termination value.	0x0	R/W
0x2AC	TERM_BLK1_RD_REG0	[7:4]	Reserved		Reserved.	0x0	R
		[3:0]	SPI_O_RCAL_CODE_TERMBLK1		Readback of calibration code for PHY 0, PHY 1, PHY 6, and PHY 7.	0x0	R
0x2AE	TERM_BLK2_CTRLREG0	[7:1]	Reserved		Reserved.	0x0	R
		0	SPI_I_TUNE_R_CAL_TERMBLK2		Rising edge of this bit starts a termination calibration routine.	0x0	R/W

Hex. Addr.	Register Name	Bit No.	Bit Name	Settings	Description	Reset	Access
0x2AF	TERM_BLK2_CTRLREG1	[7:0]	SPI_I_SERIALIZER_RTRIM_TERMBLK2	XXXXXXXX XXX1000X XXX1001X XXX1010X XXX1011X XXX1100X XXX1101X XXX1110X XXX1111X XXX1000X	SPI override for termination value for PHY 2, PHY 3, PHY 4, and PHY 5. Value options are as follows:  Automatically calibrate termination value. Force 000 as termination value. Force 001 as termination value. Force 010 as termination value. Force 011 as termination value. Force 100 as termination value. Force 101 as termination value. Force 110 as termination value. Force 111 as termination value. Force 000 as termination value.	0x0	R/W
0x2B3	TERM_BLK2_RD_REG0	[7:4]	Reserved		Reserved.	0x0	R
		[3:0]	SPI_O_RCAL_CODE_TERMBLK2		Readback of calibration code for PHY 2, PHY 3, PHY 4, and PHY 5.	0x0	R
0x2BB	TERM_OFFSET_0	[7:4]	Reserved		Reserved.	0x0	R
		[3:0]	TERM_OFFSET_0		Add or subtract from the termination calibration value of Physical Lane 0. 4-bit signed magnitude value that adds to or subtracts from the termination value. Bit 3 is the sign bit, and Bits[2:0] are the magnitude bits.	0x0	R/W
0x2BC	TERM_OFFSET_1	[7:4]	Reserved		Reserved.	0x0	R
		[3:0]	TERM_OFFSET_1		Add or subtract from the termination calibration value of Physical Lane 1. 4-bit signed magnitude value that adds to or subtracts from the termination value. Bit 3 is the sign bit, and Bits[2:0] are the magnitude bits.	0x0	R/W
0x2BD	TERM_OFFSET_2	[7:4]	Reserved		Reserved.	0x0	R
		[3:0]	TERM_OFFSET_2		Add or subtract from the termination calibration value of Physical Lane 2. 4-bit signed magnitude value that adds to or subtracts from the termination value. Bit 3 is the sign bit, and Bits[2:0] are the magnitude bits.	0x0	R/W
0x2BE	TERM_OFFSET_3	[7:4]	Reserved		Reserved.	0x0	R
		[3:0]	TERM_OFFSET_3		Add or subtract from the termination calibration value of Physical Lane 3. 4-bit signed magnitude value that adds to or subtracts from the termination value. Bit 3 is the sign bit, and Bits[2:0] are the magnitude bits.	0x0	R/W

Hex. Addr.	Register Name	Bit No.	Bit Name	Settings	Description	Reset	Access
0x2BF	TERM_OFFSET_4	[7:4]	Reserved		Reserved.	0x0	R
		[3:0]	TERM_OFFSET_4		Add or subtract from the termination calibration value of Physical Lane 4. 4-bit signed magnitude value that adds to or subtracts from the termination value. Bit 3 is the sign bit, and Bits[2:0] are the magnitude bits.	0x0	R/W
0x2C0	TERM_OFFSET_5	[7:4]	Reserved		Reserved.	0x0	R
		[3:0]	TERM_OFFSET_5		Add or subtract from the termination calibration value of Physical Lane 5. 4-bit signed magnitude value that adds to or subtracts from the termination value. Bit 3 is the sign bit, and Bits[2:0] are the magnitude bits.	0x0	R/W
0x2C1	TERM_OFFSET_6	[7:4]	Reserved		Reserved.	0x0	R
		[3:0]	TERM_OFFSET_6		Add or subtract from the termination calibration value of Physical Lane 6. 4-bit signed magnitude value that adds to or subtracts from the termination value. Bit 3 is the sign bit, and Bits[2:0] are the magnitude bits.	0x0	R/W
0x2C2	TERM_OFFSET_7	[7:4]	Reserved		Reserved.	0x0	R
		[3:0]	TERM_OFFSET_7		Add or subtract from the termination calibration value of Physical Lane 7. 4-bit signed magnitude value that adds to or subtracts from the termination value. Bit 3 is the sign bit, and Bits[2:0] are the magnitude bits.	0x0	R/W
0x300	GENERAL_JRX_CTRL_0	7	Reserved		Reserved.	0x0	R
		6	CHECKSUM_MODE		JESD204B link parameter checksum calculation method. 0 Checksum is sum of fields. 1 Checksum is sum of octets.	0x0	R/W
		[5:1]	Reserved		Reserved.	0x0	R
		0	LINK_EN		This bit brings up the JESD204B receiver when all link parameters are programmed and all clocks are ready.	0x0	R/W
0x302	DYN_LINK_LATENCY_0	[7:5]	Reserved		Reserved.	0x0	R
		[4:0]	DYN_LINK_LATENCY_0		Measurement of the JESD204B link delay (in PCLK units). Link 0 dynamic link latency. Latency between current deframer LMFC and the global LMFC.	0x0	R
0x304	LMFC_DELAY_0	[7:5]	Reserved		Reserved.	0x0	R
		[4:0]	LMFC_DELAY_0		Fixed part of the JESD204B link delay (in PCLK units). Delay in frame clock cycles for global LMFC for Link 0.	0x0	R/W



Hex. Addr.	Register Name	Bit No.	Bit Name	Settings	Description	Reset	Access
0x306	LMFC_VAR_0	[7:5]	Reserved		Reserved.	0x0	R
		[4:0]	LMFC_VAR_0		Variable part of the JESD204B link delay (in PCLK units). Location in Rx LMFC where JESD204B words are read out from buffer. This setting must not be more than 10 PCLKs.	0x1F	R/W
0x308	XBAR_LN_0_1	[7:6]	Reserved		Reserved.	0x0	R
		[5:3]	SRC_LANE1		Select data from SERDINx±, for Logical Lane 1. 000 Data is from SERDIN0±. 001 Data is from SERDIN1±. 010 Data is from SERDIN2±. 011 Data is from SERDIN3±. 100 Data is from SERDIN4±. 101 Data is from SERDIN5±. 110 Data is from SERDIN6±. 111 Data is from SERDIN7±.	0x1	R/W
		[2:0]	SRC_LANE0		Select data from SERDINx± for Logical Lane 0. 000 Data is from SERDIN0±. 001 Data is from SERDIN1±. 010 Data is from SERDIN2±. 011 Data is from SERDIN3±. 100 Data is from SERDIN4±. 101 Data is from SERDIN5±. 110 Data is from SERDIN6±. 111 Data is from SERDIN7±.	0x0	R/W
0x309	XBAR_LN_2_3	[7:6]	Reserved		Reserved.	0x0	R
		[5:3]	SRC_LANE3		Select data from SERDINx± for Logical Lane 3. 000 Data is from SERDIN0±. 001 Data is from SERDIN1±. 010 Data is from SERDIN2±. 011 Data is from SERDIN3±. 100 Data is from SERDIN4±. 101 Data is from SERDIN5±. 110 Data is from SERDIN6±. 111 Data is from SERDIN7±.	0x3	R/W
		[2:0]	SRC_LANE2		Select data from SERDINx± for Logical Lane 2. 000 Data is from SERDIN0±. 001 Data is from SERDIN1±. 010 Data is from SERDIN2±. 011 Data is from SERDIN3±. 100 Data is from SERDIN4±. 101 Data is from SERDIN5±. 110 Data is from SERDIN6±. 111 Data is from SERDIN7±.	0x2	R/W
0x30A	XBAR_LN_4_5	[7:6]	Reserved		Reserved.	0x0	R
		[5:3]	SRC_LANE5		Select data from SERDINx± for Logical Lane 5. 000 Data is from SERDIN0±. 001 Data is from SERDIN1±. 010 Data is from SERDIN2±. 011 Data is from SERDIN3±. 100 Data is from SERDIN4±.	0x5	R/W

Hex. Addr.	Register Name	Bit No.	Bit Name	Settings	Description	Reset	Access
				101	Data is from SERDIN5±.		
				110	Data is from SERDIN6±.		
				111	Data is from SERDIN7±.		
		[2:0]	SRC_LANE4		Select data from SERDINx± for Logical Lane 4.	0x4	R/W
				000	Data is from SERDIN0±.		
				001	Data is from SERDIN1±.		
				010	Data is from SERDIN2±.		
				011	Data is from SERDIN3±.		
				100	Data is from SERDIN4±.		
				101	Data is from SERDIN5±.		
				110	Data is from SERDIN6±.		
				111	Data is from SERDIN7±.		
0x30B	XBAR_LN_6_7	[7:6]	Reserved		Reserved.	0x0	R
		[5:3]	SRC_LANE7		Select data from SERDINx± for Logical Lane 7.	0x7	R/W
				000	Data is from SERDIN0±.		
				001	Data is from SERDIN1±.		
				010	Data is from SERDIN2±.		
				011	Data is from SERDIN3±.		
				100	Data is from SERDIN4±.		
				101	Data is from SERDIN5±.		
				110	Data is from SERDIN6±.		
				111	Data is from SERDIN7±.		
		[2:0]	SRC_LANE6		Select data from SERDINx± for Logical Lane 6.	0x6	R/W
				000	Data is from SERDIN0±.		
				001	Data is from SERDIN1±.		
				010	Data is from SERDIN2±.		
				011	Data is from SERDIN3±.		
				100	Data is from SERDIN4±.		
				101	Data is from SERDIN5±.		
				110	Data is from SERDIN6±.		
				111	Data is from SERDIN7±.		
0x30C	FIFO_STATUS_REG_0	[7:0]	LANE_FIFO_FULL		Bit 0 corresponds to FIFO full flag for data from SERDIN0±. Bit 1 corresponds to FIFO full flag for data from SERDIN1±. Bit 2 corresponds to FIFO full flag for data from SERDIN2±. Bit 3 corresponds to FIFO full flag for data from SERDIN3±. Bit 4 corresponds to FIFO full flag for data from SERDIN4±. Bit 5 corresponds to FIFO full flag for data from SERDIN5±. Bit 6 corresponds to FIFO full flag for data from SERDIN6±. Bit 7 corresponds to FIFO full flag for data from SERDIN7±.	0x0	R

Hex. Addr.	Register Name	Bit No.	Bit Name	Settings	Description	Reset	Access
0x30D	FIFO_STATUS_REG_1	[7:0]	LANE_FIFO_EMPTY		<p>Bit 0 corresponds to FIFO empty flag for data from SERDIN0±.</p> <p>Bit 1 corresponds to FIFO empty flag for data from SERDIN1±.</p> <p>Bit 2 corresponds to FIFO empty flag for data from SERDIN2±.</p> <p>Bit 3 corresponds to FIFO empty flag for data from SERDIN3±.</p> <p>Bit 4 corresponds to FIFO empty flag for data from SERDIN4±.</p> <p>Bit 5 corresponds to FIFO empty flag for data from SERDIN5±.</p> <p>Bit 6 corresponds to FIFO empty flag for data from SERDIN6±.</p> <p>Bit 7 corresponds to FIFO empty flag for data from SERDIN7±.</p>	0x0	R
0x311	SYNC_GEN_0	[7:3]	Reserved		Reserved.	0x0	R
		2	EOMF_MASK_0		<p>Mask end of multiframe (EOMF) flag, based on output from QBD Lane 0. Controls whether SYNCOUT± is asserted in response to loss of multiframe sync.</p> <p>0 Do not assert SYNCOUT± on loss of multiframe.</p> <p>1 Assert SYNCOUT± on loss of multiframe.</p>	0x0	R/W
		1	Reserved		Reserved.	0x0	R/W
		0	EOF_MASK_0		<p>Mask end of frame (EOF) flag, based on output from QBD Lane 0. Controls whether SYNCOUT± is asserted in response to loss of frame sync.</p> <p>0 Do not assert SYNCOUT± on loss of frame.</p> <p>1 Assert SYNCOUT± on loss of frame.</p>	0x0	R/W
0x312	SYNC_GEN_1	[7:4]	SYNC_ERR_DUR		Duration of SYNCOUT± signal low for purpose of sync error report. 0 means half PCLK cycle. Add an additional PCLK = 4 octets for each increment of the value.	0x0	R/W
		[3:0]	SYNC_SYNCREQ_DUR		Duration of SYNCOUT± signal low for purpose of sync request. 0 means 5 frames + 9 octets. Add an additional PCLK = 4 octets for each increment of the value.	0x0	R/W
0x313	SYNC_GEN_3	[7:0]	LMFC_PERIOD		LMFC period in PCLK cycle. This is to report the global LMFC period based on PCLK.	0x0	R

Hex. Addr.	Register Name	Bit No.	Bit Name	Settings	Description	Reset	Access
0x315	PHY_PRBS_TEST_EN	[7:0]	PHY_TEST_EN		Enable PHY BER by ungating the clocks. 1 PHY test enable. 0 PHY test disable.	0x0	R/W
0x316	PHY_PRBS_TEST_CTRL	7	Reserved		Reserved.	0x0	R
		[6:4]	PHY_SRC_ERR_CNT		000 Report Lane 0 error count. 001 Report Lane 1 error count. 010 Report Lane 2 error count. 011 Report Lane 3 error count. 100 Report Lane 4 error count. 101 Report Lane 5 error count. 110 Report Lane 6 error count. 111 Report Lane 7 error count.	0x0	R/W
		[3:2]	PHY_PRBS_PAT_SEL		Select PRBS pattern for PHY BER test. 00 PRBS7. 01 PRBS15. 10 PRBS31. 11 Not used.	0x0	R/W
		1	PHY_TEST_START		Start and stop the PHY PRBS test. 0 Test not started. 1 Test started.	0x0	R/W
		0	PHY_TEST_RESET		Reset PHY PRBS test state machine and error counters. 0 Not reset. 1 Reset.	0x0	R/W
0x317	PHY_PRBS_TEST_THRESHOLD_LOBITS	[7:0]	PHY_PRBS_THRESHOLD_LOBITS		Bits[7:0] of the 24-bit threshold value set the error flag for PHY PRBS test.	0x0	R/W
0x318	PHY_PRBS_TEST_THRESHOLD_MIDBITS	[7:0]	PHY_PRBS_THRESHOLD_MIDBITS		Bits[15:8] of the 24-bit threshold value set the error flag for PHY PRBS test.	0x0	R/W
0x319	PHY_PRBS_TEST_THRESHOLD_HIBITS	[7:0]	PHY_PRBS_THRESHOLD_HIBITS		Bits[23:16] of the 24-bit threshold value set the error flag for PHY PRBS test.	0x0	R/W
0x31A	PHY_PRBS_TEST_ERRCNT_LOBITS	[7:0]	PHY_PRBS_ERR_CNT_LOBITS		Bits[7:0] of the 24-bit reported PHY BER test error count from selected lane.	0x0	R
0x31B	PHY_PRBS_TEST_ERRCNT_MIDBITS	[7:0]	PHY_PRBS_ERR_CNT_MIDBITS		Bits[15:8] of the 24-bit reported PHY BER test error count from selected lane.	0x0	R
0x31C	PHY_PRBS_TEST_ERRCNT_HIBITS	[7:0]	PHY_PRBS_ERR_CNT_HIBITS		Bits[23:16] of the 24-bit reported PHY BER test error count from selected lane.	0x0	R
0x31D	PHY_PRBS_TEST_STATUS	[7:0]	PHY_PRBS_PASS		Each bit is for the corresponding lane. Report PHY BER test pass/fail for each lane.	0xFF	R

Hex. Addr.	Register Name	Bit No.	Bit Name	Settings	Description	Reset	Access
0x31E	PHY_DATA_SNAPSHOT_CTRL	[7:5]	Reserved		Reserved.	0x0	R
		[4:2]	PHY_GRAB_LANE_SEL		Select from which PHY lane to grab data.	0x0	R/W
				000	Grab data from Lane 0.		
				001	Grab data from Lane 1.		
		010	Grab data from Lane 2.				
		011	Grab data from Lane 3.				
		100	Grab data from Lane 4.				
		101	Grab data from Lane 5.				
		110	Grab data from Lane 6.				
		111	Grab data from Lane 7.				
		1	PHY_GRAB_MODE		Use error trigger to grab data.	0x0	R/W
				0	Grab data when PHY_GRAB_DATA is set.		
				1	Grab data upon bit error.		
		0	PHY_GRAB_DATA		Transition from 0 to 1 causes logic to store current receive data from one lane.	0x0	R/W
0x31F	PHY_SNAPSHOT_DATA_BYTE0	[7:0]	PHY_SNAPSHOT_DATA_BYTE0		Stores a single byte, PHY_SNAPSHOT_DATA, Bits[7:0], of a 40-bit snapshot (PHY_SNAPSHOT_DATA, Bits[39:0]) as received on a single PHY lane. The lane to be captured and the capture method is defined in Register 0x31E.	0x0	R
0x320	PHY_SNAPSHOT_DATA_BYTE1	[7:0]	PHY_SNAPSHOT_DATA_BYTE1		Stores a single byte, PHY_SNAPSHOT_DATA, Bits[15:8], of a 40-bit snapshot (PHY_SNAPSHOT_DATA, Bits[39:0]) as received on a single PHY lane. The lane to be captured and the capture method is defined in Register 0x31E.	0x0	R
0x321	PHY_SNAPSHOT_DATA_BYTE2	[7:0]	PHY_SNAPSHOT_DATA_BYTE2		Stores a single byte, PHY_SNAPSHOT_DATA, Bits[23:16], of a 40-bit snapshot (PHY_SNAPSHOT_DATA, Bits[39:0]) as received on a single PHY lane. The lane to be captured and the capture method is defined in Register 0x31E.	0x0	R
0x322	PHY_SNAPSHOT_DATA_BYTE3	[7:0]	PHY_SNAPSHOT_DATA_BYTE3		Stores a single byte, PHY_SNAPSHOT_DATA, Bits[31:24], of a 40-bit snapshot (PHY_SNAPSHOT_DATA, Bits[39:0]) as received on a single PHY lane. The lane to be captured and the capture method is defined in Register 0x31E.	0x0	R
0x323	PHY_SNAPSHOT_DATA_BYTE4	[7:0]	PHY_SNAPSHOT_DATA_BYTE4		Stores a single byte, PHY_SNAPSHOT_DATA, Bits[39:32], of a 40-bit snapshot (PHY_SNAPSHOT_DATA, Bits[39:0]) as received on a single PHY lane. The lane to be captured and the capture method is defined in Register 0x31E.	0x0	R

Hex. Addr.	Register Name	Bit No.	Bit Name	Settings	Description	Reset	Access
0x32C	SHORT_TPL_TEST_0	[7:4]	SHORT_TPL_SP_SEL		Short transport layer sample selection. Select which sample to check from a specific DAC.  0000 Sample 0. 0001 Sample 1. 0010 Sample 2. 0011 Sample 3. 0100 Sample 4. 0101 Sample 5. 0110 Sample 6. 0111 Sample 7. 1000 Sample 8. 1001 Sample 9. 1010 Sample 10. 1011 Sample 11. 1100 Sample 12. 1101 Sample 13. 1110 Sample 14. 1111 Sample 15.	0x0	R/W
		[3:2]	SHORT_TPL_M_SEL		Short transport layer test DAC selection. Select which DAC to check.  00 DAC 0. 01 DAC 1. 10 DAC 2. 11 DAC 3.	0x0	R/W
		1	SHORT_TPL_TEST_RESET		Short transport layer test reset. Resets the result of short transport layer test.  0 Not reset. 1 Reset.	0x0	R/W
		0	SHORT_TPL_TEST_EN		Short transport layer test enable. Enable short transport layer test.  0 Disable. 1 Enable.	0x0	R/W
0x32D	SHORT_TPL_TEST_1	[7:0]	SHORT_TPL_REF_SP_LSB		Short transport layer reference sample LSB. This LSB is the lower eight bits of expected DAC sample, and is used to compare with the received DAC sample at the output of JESD204B Rx.	0x0	R/W
0x32E	SHORT_TPL_TEST_2	[7:0]	SHORT_TPL_REF_SP_MSB		Short transport layer test reference sample MSB. This LSB is the upper eight bits of expected DAC sample, and is used to compare with the received sample at JESD204B Rx output.	0x0	R/W
0x32F	SHORT_TPL_TEST_3	[7:1]	Reserved		Reserved.	0x0	R
		0	SHORT_TPL_FAIL		Short transport layer test fail. This bit shows if the selected DAC sample matches the reference sample. If they match, the test passes. Otherwise, the test fails.  0 Test pass. 1 Test fail.	0x0	R

Hex. Addr.	Register Name	Bit No.	Bit Name	Settings	Description	Reset	Access
0x334	JESD_BIT_INVERSE_CTRL	[7:0]	JESD_BIT_INVERSE		Each bit of this byte inverts the JESD204B deserialized data from one specific JESD204B Rx PHY. The bit order matches the logical lane order. For example, Bit 0 controls Lane 0, Bit 1 controls Lane 1.	0x0	R/W
0x400	DID_REG	[7:0]	DID_RD		Received ILAS configuration on Lane 0. DID is the device ID number. Link information received on Lane 0 as specified in Section 8.3 of JESD204B.	0x0	R
0x401	BID_REG	[7:0]	BID_RD		Received ILAS configuration on Lane 0. BID is the bank ID, extension to DID. Link information received on Lane 0 as specified in Section 8.3 of JESD204B.	0x0	R
0x402	LIDO_REG	7	Reserved		Reserved.	0x0	R
		6	ADJDIR_RD		Received ILAS configuration on Lane 0. ADJDIR is the direction to adjust the DAC LMFC. Link information received on Lane 0 as specified in Section 8.3 of JESD204B.	0x0	R
		5	PHADJ_RD		Received ILAS configuration on Lane 0. PHADJ is the phase adjustment request to DAC. Link information received on Lane 0 as specified in Section 8.3 of JESD204B.	0x0	R
		[4:0]	LL_LIDO		Received ILAS LID configuration on Lane 0. LIDO is the lane identification for Lane 0. Link information received on Lane 0 as specified in Section 8.3 of JESD204B.	0x0	R
0x403	SCR_L_REG	7	SCR_RD		Received ILAS configuration on Lane 0. SCR is the Tx scrambling status. Link information received on Lane 0 as specified in Section 8.3 of JESD204B. 0 Scrambling is disabled. 1 Scrambling is enabled.	0x0	R
		[6:5]	Reserved		Reserved.	0x0	R
		[4:0]	L_RD		Received ILAS configuration on Lane 0. L is the number of lanes per converter device. Link information received on Lane 0 as specified in Section 8.3 of JESD204B. 00000 1 lane per converter device. 00001 2 lanes per converter device. 00011 4 lanes per converter device. 00111 8 lanes per converter device.	0x0	R

Hex. Addr.	Register Name	Bit No.	Bit Name	Settings	Description	Reset	Access
0x404	F_REG	[7:0]	F_RD		Received ILAS configuration on Lane 0. F is the number of octets per frame. Settings of 1, 2, and 4 are valid (value in register is F – 1). Link information received on Lane 0 as specified in Section 8.3 of JESD204B.  0 1 octet per frame. 1 2 octets per frame. 11 4 octets per frame.	0x0	R
0x405	K_REG	[7:5]	Reserved		Reserved.	0x0	R
		[4:0]	K_RD		Received ILAS configuration on Lane 0. K is the number of frames per multiframe. Settings of 16 or 32 are valid. On this device, all modes use K = 32 (value in register is K – 1). Link information received on Lane 0 as specified in Section 8.3 of JESD204B.  01111 16 frames per multiframe. 11111 32 frames per multiframe.	0x0	R
0x406	M_REG	[7:0]	M_RD		Received ILAS configuration on Lane 0. M is the number of converters per device. Link information received on Lane 0 as specified in Section 8.3 of JESD204B. M is 1 for real interface and 2 for complex interface (value in register is M – 1).	0x0	R
0x407	CS_N_REG	[7:6]	CS_RD		Received ILAS configuration on Lane 0. CS is the number of control bits per sample. Link information received on Lane 0 as specified in Section 8.3 of JESD204B. CS is always 0 on this device.	0x0	R
		5	Reserved		Reserved.	0x0	R
		[4:0]	N_RD		Received ILAS configuration on Lane 0. N is the converter resolution. Value in register is N – 1 (for example, 16 bits = 0b01111).	0x0	R
0x408	NP_REG	[7:5]	SUBCLASSV_RD		Received ILAS configuration on Lane 0. SUBCLASSV is the device subclass version. Link information received on Lane 0 as specified in Section 8.3 of JESD204B.  000 Subclass 0. 001 Subclass 1.	0x0	R
		[4:0]	NP_RD		Received ILAS configuration on Lane 0. NP is the total number of bits per sample. Link information received on Lane 0 as specified in Section 8.3 of JESD204B. Value in register is NP – 1, for example, 16 bits per sample = 0b01111.	0x0	R



Hex. Addr.	Register Name	Bit No.	Bit Name	Settings	Description	Reset	Access
0x409	S_REG	[7:5]	JESDV_RD	000 001	Received ILAS configuration on Lane 0. JESDV is the JESD204x version. Link information received on Lane 0 as specified in Section 8.3 of JESD204B. JESD204A. JESD204B.	0x0	R
		[4:0]	S_RD		Received ILAS configuration on Lane 0. S is the number of samples per converter per frame cycle. Link information received on Lane 0 as specified in Section 8.3 of JESD204B. Value in register is S – 1.	0x0	R
0x40A	HD_CF_REG	7	HD_RD	0 1	Received ILAS configuration on Lane 0. HD is the high density format. Refer to Section 5.1.3 of JESD204B standard. Link information received on Lane 0 as specified in Section 8.3 of JESD204B. 0 Low density mode. 1 High density mode.	0x0	R
		[6:5]	Reserved		Reserved.	0x0	R
		[4:0]	CF_RD		Received ILAS configuration on Lane 0. CF is the number of control words per frame clock period per link. Link information received on Lane 0 as specified in Section 8.3 of JESD204B. CF is always 0 on this device.	0x0	R
0x40B	RES1_REG	[7:0]	RES1_RD		Received ILAS configuration on Lane 0. Reserved Field 1. Link information received on Lane 0 as specified in Section 8.3 of JESD204B.	0x0	R
0x40C	RES2_REG	[7:0]	RES2_RD		Received ILAS configuration on Lane 0. Reserved Field 2. Link information received on Lane 0 as specified in Section 8.3 of JESD204B.	0x0	R
0x40D	CHECKSUM0_REG	[7:0]	LL_FCHK0		Received checksum during ILAS on Lane 0. Checksum for Lane 0. Link information received on Lane 0 as specified in Section 8.3 of JESD204B.	0x0	R
0x40E	COMPSUM0_REG	[7:0]	LL_FCMP0		Computed checksum on Lane 0. Computed checksum for Lane 0. The JESD204B Rx computes the checksum of the link information received on Lane 0 as specified in Section 8.3 of JESD204B. The computation method is set by the CHECKSUM_MODE bit (Register 0x300, Bit 6) and must match the likewise calculated checksum in Register 0x40D.	0x0	R

Hex. Addr.	Register Name	Bit No.	Bit Name	Settings	Description	Reset	Access
0x412	LID1_REG	[7:5]	Reserved		Reserved.	0x0	R
		[4:0]	LL_LID1		Received lane ID (LID) during ILAS on Lane 1. Link information received on Lane 0 as specified in Section 8.3 of JESD204B.	0x0	R
0x415	CHECKSUM1_REG	[7:0]	LL_FCHK1		Received checksum during ILAS on Lane 1. Link information received on Lane 0 as specified in Section 8.3 of JESD204B.	0x0	R
0x416	COMPSUM1_REG	[7:0]	LL_FCMP1		Computed checksum on Lane 1 (see description for Register 0x40E).	0x0	R
0x41A	LID2_REG	[7:5]	Reserved		Reserved.	0x0	R
		[4:0]	LL_LID2		Received lane ID (LID) during ILAS on Lane 2.	0x0	R
0x41D	CHECKSUM2_REG	[7:0]	LL_FCHK2		Received checksum during ILAS on Lane 2	0x0	R
0x41E	COMPSUM2_REG	[7:0]	LL_FCMP2		Computed checksum on Lane 2 (see description for Register 0x40E).	0x0	R
0x422	LID3_REG	[7:5]	Reserved		Reserved.	0x0	R
		[4:0]	LL_LID3		Received lane ID (LID) during ILAS on Lane 3.	0x0	R
0x425	CHECKSUM3_REG	[7:0]	LL_FCHK3		Received checksum during ILAS on Lane 3	0x0	R
0x426	COMPSUM3_REG	[7:0]	LL_FCMP3		Computed checksum on Lane 3 (see description for Register 0x40E).	0x0	R
0x42A	LID4_REG	[7:5]	Reserved		Reserved.	0x0	R
		[4:0]	LL_LID4		Received LID during ILAS on Lane 4.	0x0	R
0x42D	CHECKSUM4_REG	[7:0]	LL_FCHK4		Received checksum during ILAS on Lane 4	0x0	R
0x42E	COMPSUM4_REG	[7:0]	LL_FCMP4		Computed checksum on Lane 4 (see description for Register 0x40E).	0x0	R
0x432	LID5_REG	[7:5]	Reserved		Reserved.	0x0	R
		[4:0]	LL_LID5		Received LID during ILAS on Lane 5.	0x0	R
0x435	CHECKSUM5_REG	[7:0]	LL_FCHK5		Received checksum during ILAS on Lane 5	0x0	R
0x436	COMPSUM5_REG	[7:0]	LL_FCMP5		Computed checksum on Lane 5 (see description for Register 0x40E).	0x0	R
0x43A	LID6_REG	[7:5]	Reserved		Reserved.	0x0	R
		[4:0]	LL_LID6		Received LID during ILAS on Lane 6.	0x0	R
0x43D	CHECKSUM6_REG	[7:0]	LL_FCHK6		Received checksum during ILAS on Lane 6	0x0	R
0x43E	COMPSUM6_REG	[7:0]	LL_FCMP6		Computed checksum on Lane 6 (see description for Register 0x40E).	0x0	R
0x442	LID7_REG	[7:5]	Reserved		Reserved.	0x0	R
		[4:0]	LL_LID7		Received LID during ILAS on Lane 7.	0x0	R
0x445	CHECKSUM7_REG	[7:0]	LL_FCHK7		Received checksum during ILAS on Lane 7.	0x0	R
0x446	COMPSUM7_REG	[7:0]	LL_FCMP7		Computed checksum on Lane 7 (see description for Register 0x40E).	0x0	R

Hex. Addr.	Register Name	Bit No.	Bit Name	Settings	Description	Reset	Access
0x450	ILS_DID	[7:0]	DID		Device (link) identification number (DID). DID is the device ID number. Link information received on Lane 0 as specified in Section 8.3 of JESD204B. Must be set to the value read in Register 0x400. This signal must only be programmed while the QBD is held in soft reset (Register 0x475, Bit 3), and must not be changed during normal operation.	0x0	R/W
0x451	ILS_BID	[7:0]	BID		Bank ID, extension to DID. This signal must only be programmed while the QBD is held in soft reset (Register 0x475, Bit 3), and must not be changed during normal operation.	0x0	R/W
0x452	ILS_LID0	7	Reserved		Reserved.	0x0	R
		6	ADJDIR		Direction to adjust DAC LMFC (Subclass 2 only). ADJDIR is the direction to adjust DAC LMFC. Link information received on Lane 0 as specified in Section 8.3 of JESD204B. This signal must only be programmed while the QBD is held in soft reset (Register 0x475, Bit 3), and must not be changed during normal operation.	0x0	R/W
		5	PHADJ		Phase adjustment to DAC (Subclass 2 only). PHADJ is the phase adjustment request to the DAC. Link information received on Lane 0 as specified in Section 8.3 of JESD204B. This signal must only be programmed while the QBD is held in soft reset (Register 0x475, Bit 3), and must not be changed during normal operation.	0x0	R/W
		[4:0]	LID0		Lane identification number (within link). LID0 is the lane identification for Lane 0. Link information received on Lane 0 as specified in Section 8.3 of JESD204B. This signal must only be programmed while the QBD is held in soft reset (Register 0x475, Bit 3), and must not be changed during normal operation.	0x0	R/W
0x453	ILS_SCR_L	7	SCR		Scramble enable. SCR is the Rx descrambling enable. This signal must only be programmed while the QBD is held in soft reset (Register 0x475, Bit 3), and must not be changed during normal operation. 0 Descrambling is disabled. 1 Descrambling is enabled.	0x1	R/W

Hex. Addr.	Register Name	Bit No.	Bit Name	Settings	Description	Reset	Access
		[6:5]	Reserved		Reserved.	0x0	R
		[4:0]	L		Number of lanes per converter (minus 1). L is the number of lanes per converter device. Settings of 1, 2, 3, 4, 6, and 8 are valid. Refer to Table 15 and Table 16.	0x7	R
0x454	ILS_F	[7:0]	F		Number of octets per frame (minus 1). This value of F is not used to soft configure the QBD. Register CTRLREG1 is used to soft configure the QBD.	0x0	R
0x455	ILS_K	[7:5]	Reserved		Reserved.	0x0	R
		[4:0]	K		Number of frames per multiframe (minus 1). K is the number of frames per multiframe. On this device, all modes use K = 32 (value in register is K – 1). This signal must only be programmed while the QBD is held in soft reset (Register 0x475, Bit 3), and must not be changed during normal operation.  01111 16 frames per multiframe. 11111 32 frames per multiframe.	0x1F	R/W
0x456	ILS_M	[7:0]	M		Number of converters per device (minus 1). M is the number of converters/device. Settings of 1 and 2 are valid. Refer to Table 15 and Table 16.	0x1	R
0x457	ILS_CS_N	[7:6]	CS		Number of control bits per sample. CS is the number of control bits per sample. Must be set to 0. Control bits are not supported.	0x0	R
		5	Reserved		Reserved.	0x0	R
		[4:0]	N		Converter resolution (minus 1). N is the converter resolution. Must be set to 16 (0x0F).	0xF	R
0x458	ILS_NP	[7:5]	SUBCLASSV		Device subclass version. SUBCLASSV is the device subclass version. This signal must only be programmed while the QBD is held in soft reset (Register 0x475, Bit 3), and must not be changed during normal operation.  000 Subclass 0. 001 Subclass 1. 010 Subclass 2 (not supported).	0x0	R/W
		[4:0]	NP		Total number of bits per sample (minus 1). NP is the total number of bits per sample. Must be set to 16 (0x0F). Refer to Table 15 and Table 16.	0xF	R

Hex. Addr.	Register Name	Bit No.	Bit Name	Settings	Description	Reset	Access
0x459	ILS_S	[7:5]	JESDV		JESD204x version. JESDV is the JESD204x version. This signal must only be programmed while the QBD is held in soft reset (Register 0x475, Bit 3), and must not be changed during normal operation.	0x0	R/W
				000 001	JESD204A. JESD204B.		
		[4:0]	S		Number of samples per converter per frame cycle (minus 1). S is the number of samples per converter per frame cycle. Settings of 1 and 2 are valid. Refer to Table 15 and Table 16.	0x1	R
0x45A	ILS_HD_CF	7	HD		High density format. HD is the high density mode. Refer to Section 5.1.3 of JESD204B standard.	0x1	R
				0 1	Low density mode. High density mode.		
		[6:5]	Reserved		Reserved.		
		[4:0]	CF		Number of control bits per sample. CF is the number of control words per frame clock period per link. Must be set to 0. Control bits are not supported.	0x0	R
0x45B	ILS_RES1	[7:0]	RES1		Reserved. Reserved Field 1. This signal must only be programmed while the QBD is held in soft reset (Register 0x475, Bit 3), and must not be changed during normal operation.	0x0	R/W
0x45C	ILS_RES2	[7:0]	RES2		Reserved. Reserved Field 2. This signal must only be programmed while the QBD is held in soft reset (Register 0x475, Bit 3), and must not be changed during normal operation.	0x0	R/W
0x45D	ILS_CHECKSUM	[7:0]	FCHK0		Link configuration checksum. Checksum for Lane 0. The checksum for the values programmed into Register 0x450 to Register 0x45C must be calculated according to Section 8.3 of the JESD204B specification and written to this register (SUM(Register 0x450 to Register 0x45C) % 256). This signal must only be programmed while the QBD is held in soft reset (Register 0x475, Bit 3), and must not be changed during normal operation.	0x0	R/W

Hex. Addr.	Register Name	Bit No.	Bit Name	Settings	Description	Reset	Access
0x46C	LANE_DESKEW	7	ILD7		Interlane deskew status for Lane 7 (ignore this output when NO_ILAS = 1). 0 Deskew failed. 1 Deskew achieved.	0x0	R
		6	ILS6		Initial lane synchronization status for Lane 6 (ignore this output when NO_ILAS = 1). 0 Synchronization lost. 1 Synchronization achieved.	0x0	R
		5	ILD5		Interlane deskew status for Lane 5 (ignore this output when NO_ILAS = 1). 0 Deskew failed. 1 Deskew achieved.	0x0	R
		4	ILD4		Interlane deskew status for Lane 4 (ignore this output when NO_ILAS = 1). 0 Deskew failed. 1 Deskew achieved.	0x0	R
		3	ILD3		Interlane deskew status for Lane 3 (ignore this output when NO_ILAS = 1). 0 Deskew failed. 1 Deskew achieved.	0x0	R
		2	ILD2		Interlane deskew status for Lane 2 (ignore this output when NO_ILAS = 1). 0 Deskew failed. 1 Deskew achieved.	0x0	R
		1	ILD1		Interlane deskew status for Lane 1 (ignore this output when NO_ILAS = 1). 0 Deskew failed. 1 Deskew achieved.	0x0	R
		0	ILD0		Interlane deskew status for Lane 0 (ignore this output when NO_ILAS = 1). 0 Deskew failed. 1 Deskew achieved.	0x0	R
0x46D	BAD_DISPARITY	7	BDE7		BDE status for Lane 7. 0 Error count < ETH[7:0] value. 1 Error count ≥ ETH[7:0] value.	0x0	R
		6	BDE6		BDE status for Lane 6. 0 Error count < ETH[7:0] value. 1 Error count ≥ ETH[7:0] value.	0x0	R
		5	BDE5		BDE status for Lane 5. 0 Error count < ETH[7:0] value. 1 Error count ≥ ETH[7:0] value.	0x0	R
		4	BDE4		BDE status for Lane 4. 0 Error count < ETH[7:0] value. 1 Error count ≥ ETH[7:0] value.	0x0	R
		3	BDE3		BDE status for Lane 3. 0 Error count < ETH[7:0] value. 1 Error count ≥ ETH[7:0] value.	0x0	R

Hex. Addr.	Register Name	Bit No.	Bit Name	Settings	Description	Reset	Access
		2	BDE2		BDE status for Lane 2. 0 Error count < ETH[7:0] value. 1 Error count ≥ ETH[7:0] value.	0x0	R
		1	BDE1		BDE status for Lane 1. 0 Error count < ETH[7:0] value. 1 Error count ≥ ETH[7:0] value.	0x0	R
		0	BDE0		BDE status for Lane 0. 0 Error count < ETH[7:0] value. 1 Error count ≥ ETH[7:0] value.	0x0	R
0x46E	NOT_IN_TABLE	7	NIT7		NIT error status for Lane 7. 0 Error count < ETH[7:0] value. 1 Error count ≥ ETH[7:0] value.	0x0	R
		6	NIT6		NIT error status for Lane 6. 0 Error count < ETH[7:0] value. 1 Error count ≥ ETH[7:0] value.	0x0	R
		5	NIT5		NIT errors status for Lane 5. 0 Error count < ETH[7:0] value. 1 Error count ≥ ETH[7:0] value.	0x0	R
		4	NIT4		NIT error status for Lane 4. 0 Error count < ETH[7:0] value. 1 Error count ≥ ETH[7:0] value.	0x0	R
		3	NIT3		NIT error status for Lane 3. 0 Error count < ETH[7:0] value. 1 Error count ≥ ETH[7:0] value.	0x0	R
		2	NIT2		NIT error status for Lane 2. 0 Error count < ETH[7:0] value. 1 Error count ≥ ETH[7:0] value.	0x0	R
		1	NIT1		NIT error status for Lane 1. 0 Error count < ETH[7:0] value. 1 Error count ≥ ETH[7:0] value.	0x0	R
		0	NIT0		NIT error status for Lane 0. 0 Error count < ETH[7:0] value. 1 Error count ≥ ETH[7:0] value.	0x0	R
0x46F	UNEXPECTED_KCHAR	7	UEK7		UEK character error status for Lane 7. 0 Error count < ETH[7:0] value. 1 Error count ≥ ETH[7:0] value.	0x0	R
		6	UEK6		UEK character error status for Lane 6. 0 Error count < ETH[7:0] value. 1 Error count ≥ ETH[7:0] value.	0x0	R
		5	UEK5		UEK character error status for Lane 5. 0 Error count < ETH[7:0] value. 1 Error count ≥ ETH[7:0] value.	0x0	R
		4	UEK4		UEK character error status for Lane 4. 0 Error count < ETH[7:0] value. 1 Error count ≥ ETH[7:0] value.	0x0	R
		3	UEK3		UEK character error status for Lane 3. 0 Error count < ETH[7:0] value. 1 Error count ≥ ETH[7:0] value.	0x0	R

Hex. Addr.	Register Name	Bit No.	Bit Name	Settings	Description	Reset	Access
		2	UEK2		UEK character error status for Lane 2. 0 Error count < ETH[7:0] value. 1 Error count ≥ ETH[7:0] value.	0x0	R
		1	UEK1		UEK character error status for Lane 1. 0 Error count < ETH[7:0] value. 1 Error count ≥ ETH[7:0] value.	0x0	R
		0	UEK0		UEK character error status for Lane 0. 0 Error count < ETH[7:0] value. 1 Error count ≥ ETH[7:0] value.	0x0	R
0x470	CODE_GRP_SYNC	7	CGS7		CGS status for Lane 7. 0 Synchronization lost. 1 Synchronization achieved.	0x0	R
		6	CGS6		CGS status for Lane 6. 0 Synchronization lost. 1 Synchronization achieved.	0x0	R
		5	CGS5		CGS status for Lane 5. 0 Synchronization lost. 1 Synchronization achieved.	0x0	R
		4	CGS4		CGS status for Lane 4. 0 Synchronization lost. 1 Synchronization achieved.	0x0	R
		3	CGS3		CGS status for Lane 3. 0 Synchronization lost. 1 Synchronization achieved.	0x0	R
		2	CGS2		CGS status for Lane 2. 0 Synchronization lost. 1 Synchronization achieved.	0x0	R
		1	CGS1		CGS status for Lane 1. 0 Synchronization lost. 1 Synchronization achieved.	0x0	R
		0	CGS0		CGS status for Lane 0. 0 Synchronization lost. 1 Synchronization achieved.	0x0	R
0x471	FRAME_SYNC	7	FS7		Frame sync status for Lane 7 (ignore this output when NO_ILAS = 1). 0 Synchronization lost. 1 Synchronization achieved.	0x0	R
		6	FS6		Frame sync status for Lane 6 (ignore this output when NO_ILAS = 1). 0 Synchronization lost. 1 Synchronization achieved.	0x0	R
		5	FS5		Frame sync status for Lane 5 (ignore this output when NO_ILAS = 1). 0 Synchronization lost. 1 Synchronization achieved.	0x0	R
		4	FS4		Frame sync status for Lane 4 (ignore this output when NO_ILAS = 1). 0 Synchronization lost. 1 Synchronization achieved.	0x0	R



Hex. Addr.	Register Name	Bit No.	Bit Name	Settings	Description	Reset	Access
		3	FS3		Frame sync status for Lane 3 (ignore this output when NO_ILAS = 1). 0 Synchronization lost. 1 Synchronization achieved.	0x0	R
		2	FS2		Frame sync status for Lane 2 (ignore this output when NO_ILAS = 1). 0 Synchronization lost. 1 Synchronization achieved.	0x0	R
		1	FS1		Frame sync status for Lane 1 (ignore this output when NO_ILAS = 1). 0 Synchronization lost. 1 Synchronization achieved.	0x0	R
		0	FS0		Frame sync status for Lane 0 (ignore this output when NO_ILAS = 1). 0 Synchronization lost. 1 Synchronization achieved.	0x0	R
0x472	GOOD_CHECKSUM	7	CKS7		Computed checksum status for Lane 7 (ignore this output when NO_ILAS = 1). 0 Checksum is incorrect. 1 Checksum is correct.	0x0	R
		6	CKS6		Computed checksum status for Lane 6 (ignore this output when NO_ILAS = 1). 0 Checksum is incorrect. 1 Checksum is correct.	0x0	R
		5	CKS5		Computed checksum status for Lane 5 (ignore this output when NO_ILAS = 1). 0 Checksum is incorrect. 1 Checksum is correct.	0x0	R
		4	CKS4		Computed checksum status for Lane 4 (ignore this output when NO_ILAS = 1). 0 Checksum is incorrect. 1 Checksum is correct.	0x0	R
		3	CKS3		Computed checksum status for Lane 3 (ignore this output when NO_ILAS = 1). 0 Checksum is incorrect. 1 Checksum is correct.	0x0	R
		2	CKS2		Computed checksum status for Lane 2 (ignore this output when NO_ILAS = 1). 0 Checksum is incorrect. 1 Checksum is correct.	0x0	R
		1	CKS1		Computed checksum status for Lane 1 (ignore this output when NO_ILAS = 1). 0 Checksum is incorrect. 1 Checksum is correct.	0x0	R

Hex. Addr.	Register Name	Bit No.	Bit Name	Settings	Description	Reset	Access
		0	CKS0		Computed checksum status for Lane 0 (ignore this output when NO_ILAS = 1). 0 Checksum is incorrect. 1 Checksum is correct.	0x0	R
0x473	INIT_LANE_SYNC	7	ILS7		Initial lane synchronization status for Lane 7 (ignore this output when NO_ILAS = 1). 0 Synchronization lost. 1 Synchronization achieved.	0x0	R
		6	ILS6		Initial lane synchronization status for Lane 6 (ignore this output when NO_ILAS = 1). 0 Synchronization lost. 1 Synchronization achieved.	0x0	R
		5	ILS5		Initial lane synchronization status for Lane 5 (ignore this output when NO_ILAS = 1). 0 Synchronization lost. 1 Synchronization achieved.	0x0	R
		4	ILS4		Initial lane synchronization status for Lane 4 (ignore this output when NO_ILAS = 1). 0 Synchronization lost. 1 Synchronization achieved.	0x0	R
		3	ILS3		Initial lane synchronization status for Lane 3 (ignore this output when NO_ILAS = 1). 0 Synchronization lost. 1 Synchronization achieved.	0x0	R
		2	ILS2		Initial lane synchronization status for Lane 2 (ignore this output when NO_ILAS = 1). 0 Synchronization lost. 1 Synchronization achieved.	0x0	R
		1	ILS1		Initial lane synchronization status for Lane 1 (ignore this output when NO_ILAS = 1). 0 Synchronization lost. 1 Synchronization achieved.	0x0	R
		0	ILS0		Initial lane synchronization status for Lane 0 (ignore this output when NO_ILAS = 1). 0 Synchronization lost. 1 Synchronization achieved.	0x0	R
0x475	CTRLREG0	7	RX_DIS		Level input: disable deframer receiver when this input = 1. This signal must only be programmed while the QBD is held in soft reset (Register 0x475, Bit 3), and must not be changed during normal operation. 1 Disable character replacement of /A/ and /F/ control characters at the end of received frames and multiframes. 0 Enables the substitution.	0x0	R/W

Hex. Addr.	Register Name	Bit No.	Bit Name	Settings	Description	Reset	Access
		6	CHAR_REPL_DIS		When this input = 1, character replacement at the end of frame/multiframe is disabled. This signal must only be programmed while the QBD is held in soft reset (Register 0x475, Bit 3), and must not be changed during normal operation.	0x0	R/W
		[5:4]	Reserved		Reserved.	0x0	R
		3	SOFTRST		Soft reset. Active high synchronous reset. Resets all hardware to power-on state. 1 Disables the deframer reception. 0 Enable deframer logic.	0x0	R/W
		2	FORCESYNCREQ		Command from application to assert a sync request (SYNCOUT±). Active high.	0x0	R/W
		1	Reserved		Reserved.	0x0	R
		0	REPL_FRM_ENA		When this level input is set, it enables replacement of frames received in error. This signal must only be programmed while the QBD is held in soft reset (Register 0x475, Bit 3), and must not be changed during normal operation.	0x1	R/W
0x476	CTRLREG1	[7:5]	Reserved		Reserved.	0x0	R
		4	QUAL_RDERR		Error reporting behavior for concurrent NIT and running disparity (RD) errors. This signal must only be programmed while the QBD is held in soft reset (Register 0x475, Bit 3), and must not be changed during normal operation. 0 NIT has no effect on RD error. 1 NIT error masks concurrent RD error.	0x1	R/W
		3	DEL_SCR		Alternative descrambler enable. (see JESD204B Section 5.2.4) This signal must only be programmed while the QBD is held in soft reset (Register 0x475, Bit 3), and must not be changed during normal operation. 1 Descrambling begins at Octet 2 of user data. 0 Descrambling begins at Octet 0 of user data. This is the common usage.	0x0	R/W
		2	CGS_SEL		Determines the QBD behavior after code group sync has been achieved. This signal must only be programmed while the QBD is held in soft reset (Register 0x475, Bit 3), and must not be changed during normal operation.	0x1	R/W

Hex. Addr.	Register Name	Bit No.	Bit Name	Settings	Description	Reset	Access
					<p>0 After code group sync is achieved, the QBD asserts SYNCOUT± only if there are sufficient disparity errors as per the JESD204B standard.</p> <p>1 After code group sync is achieved, if a /K/ is followed by any character other than an /R/ or another /K/, QBD asserts SYNCOUT±.</p>		
		1	NO_ILAS		<p>This signal must only be programmed while the QBD is held in soft reset (Register 0x475, Bit 3), and must not be changed during normal operation.</p> <p>1 For single-lane operation, ILAS is omitted. Code group sync is followed by user data.</p> <p>0 Code group sync is followed by ILAS. For multilane operation, NO_ILAS must always be set to 0.</p>	0x0	R/W
		0	FCHK_N		<p>Checksum calculation method. This signal must only be programmed while the QBD is held in soft reset (Register 0x475, Register 3), and must not be changed during normal operation.</p> <p>0 Calculate checksum by summing individual fields (this more closely matches the definition of the checksum field in the JESD204B standard).</p> <p>1 Calculate checksum by summing the registers containing the packed fields (this setting is provided in case the framer of another vendor performs the calculation with this method).</p>	0x0	R/W
0x477	CTRLREG2	7	ILS_MODE		<p>Data link layer test mode. This signal must only be programmed while the QBD is held in soft reset (Register 0x475, Bit 3), and must not be changed during normal operation.</p> <p>0 Normal mode.</p> <p>1 Code group sync pattern is followed by a perpetual ILAS sequence.</p>	0x0	R/W
		6	Reserved		Reserved.	0x0	R
		5	REPDATATEST		<p>Repetitive data test enable, using JTSPAT pattern. To enable the test, ILS_MODE must = 0. This signal must only be programmed while the QBD is held in soft reset (Register 0x475, Bit 3), and must not be changed during normal operation.</p>	0x0	R/W

Hex. Addr.	Register Name	Bit No.	Bit Name	Settings	Description	Reset	Access
		4	QUETESTERR		Queue test error mode. This signal must only be programmed while the QBD is held in soft reset (Register 0x475, Bit 3), and must not be changed during normal operation.  0 Simultaneous errors on multiple lanes are reported as one error.  1 Detected errors from all lanes are trapped in a counter and sequentially signaled on SYNCOUT±.	0x0	R/W
		3	AR_ECNTNTR		Automatic reset of error counter. The error counter that causes assertion of SYNCOUT± is automatically reset to 0 when AR_ECNTNTR = 1. All other counters are unaffected. This signal must only be programmed while the QBD is held in soft reset (Register 0x475, Bit 3), and must not be changed during normal operation.	0x0	R/W
		[2:0]	Reserved		Reserved.	0x0	R
0x478	KVAL	[7:0]	KSYNC		Number of 4 × K multiframes during ILS. F is the number of octets per frame. Settings of 1, 2, and 4 are valid. Refer to Table 15 and Table 16. This signal must only be programmed while the QBD is held in soft reset (Register 0x475, Bit 3), and must not be changed during normal operation.	0x1	R/W
0x47C	ERRORTHRES	[7:0]	ETH		Error threshold value. Bad disparity, NIT disparity, and unexpected K character errors are counted and compared to the error threshold value. When the count is equal, either an IRQ is generated or SYNCOUT± is asserted per the mask register settings or both. Function is performed in all lanes. This signal must only be programmed while the QBD is held in soft reset (Register 0x475, Bit 3), and must not be changed during normal operation.	0xFF	R/W

Hex. Addr.	Register Name	Bit No.	Bit Name	Settings	Description	Reset	Access
0x47D	SYNC_ASSERT_MASK	[7:3]	Reserved		Reserved.	0x0	R
		[2:0]	SYNC_ASSERT_MASK		SYNCOUT assertion enable mask for BD, NIT, and UEK error conditions. Active high, SYNCOUT assertion enable mask for BD, NIT, and UEK error conditions, respectively. When an error counter, in any lane, has reached the error threshold count, ETH[7:0], and the corresponding SYNC_ASSERT_MASK bit is set, SYNCOUT is asserted. The mask bits are as follows. Note that the bit sequence is reversed with respect to the other error count controls and the error counters. Bit 2 = UEK character error. Bit 1 = NIT. Bit 0 = BDE.	0x7	R/W
0x480	ECNT_CTRL0	[7:6]	Reserved		Reserved.	0x0	R
		[5:3]	ECNT_ENA0		Error counter enable for Lane 0. Counters of each lane are addressed as follows: Bit 2 = UEK character error. Bit 1 = NIT. Bit 0 = BDE.	0x7	R/W
		[2:0]	ECNT_RST0		Error counters enable for Lane 0, active high. Counters of each lane are addressed as follows: Bit 2 = UEK character error. Bit 1 = NIT. Bit 0 = BDE.	0x7	R/W
0x481	ECNT_CTRL1	[7:6]	Reserved		Reserved.	0x0	R
		[5:3]	ECNT_ENA1		Error counters enable for Lane 1, active high. Counters of each lane are addressed as follows: Bit 2 = UEK character error. Bit 1 = NIT. Bit 0 = BDE.	0x7	R/W
		[2:0]	ECNT_RST1		Error counters enable for Lane 1, active high. Counters of each lane are addressed as follows: Bit 2 = UEK character error. Bit 1 = NIT. Bit 0 = BDE.	0x7	R/W
0x482	ECNT_CTRL2	[7:6]	Reserved		Reserved.	0x0	R
		[5:3]	ECNT_ENA2		Error counters enable for Lane 2, active high. Counters of each lane are addressed as follows: Bit 2 = UEK character error. Bit 1 = NIT. Bit 0 = BDE.	0x7	R/W

Hex. Addr.	Register Name	Bit No.	Bit Name	Settings	Description	Reset	Access
		[2:0]	ECNT_RST2		Error counters enable for Lane 2, active high. Counters of each lane are addressed as follows: Bit 2 = UEK character error. Bit 1 = NIT. Bit 0 = BDE.	0x7	R/W
0x483	ECNT_CTRL3	[7:6]	Reserved		Reserved.	0x0	R
		[5:3]	ECNT_ENA3		Error counters enable for Lane 3, active high. Counters of each lane are addressed as follows: Bit 2 = UEK character error. Bit 1 = NIT. Bit 0 = BDE.	0x7	R/W
		[2:0]	ECNT_RST3		Error counters enable for Lane 3, active high. Counters of each lane are addressed as follows: Bit 2 = UEK character error. Bit 1 = NIT. Bit 0 = BDE.	0x7	R/W
0x484	ECNT_CTRL4	[7:6]	Reserved		Reserved.	0x0	R
		[5:3]	ECNT_ENA4		Error counters enable for Lane 4, active high. Counters of each lane are addressed as follows: Bit 2 = UEK character error. Bit 1 = NIT. Bit 0 = BDE.	0x7	R/W
		[2:0]	ECNT_RST4		Error counters enable for Lane 4, active high. Counters of each lane are addressed as follows: Bit 2 = UEK character error. Bit 1 = NIT. Bit 0 = BDE.	0x7	R/W
0x485	ECNT_CTRL5	[7:6]	Reserved		Reserved.	0x0	R
		[5:3]	ECNT_ENA5		Error counters enable for Lane 5, active high. Counters of each lane are addressed as follows: Bit 2 = UEK character error. Bit 1 = NIT. Bit 0 = BDE.	0x7	R/W
		[2:0]	ECNT_RST5		Error counters enable for Lane 5, active high. Counters of each lane are addressed as follows: Bit 2 = UEK character error. Bit 1 = NIT. Bit 0 = BDE.	0x7	R/W

Hex. Addr.	Register Name	Bit No.	Bit Name	Settings	Description	Reset	Access
0x486	ECNT_CTRL6	[7:6]	Reserved		Reserved.	0x0	R
		[5:3]	ECNT_ENA6		Error counters enable for Lane 6, active high. Counters of each lane are addressed as follows: Bit 2 = UEK character error. Bit 1 = NIT. Bit 0 = BDE.	0x7	R/W
		[2:0]	ECNT_RST6		Error counters enable for Lane 6, active high. Counters of each lane are addressed as follows: Bit 2 = UEK character error. Bit 1 = NIT. Bit 0 = BDE.	0x7	R/W
0x487	ECNT_CTRL7	[7:6]	Reserved		Reserved.	0x0	R
		[5:3]	ECNT_ENA7		Error counters enable for Lane 7, active high. Counters of each lane are addressed as follows: Bit 2 = UEK character error. Bit 1 = NIT. Bit 0 = BDE.	0x7	R/W
		[2:0]	ECNT_RST7		Reset error counters for Lane 7, active high. Counters of each lane are addressed as follows: Bit 2 = UEK character error. Bit 1 = NIT. Bit 0 = BDE.	0x7	R/W
0x488	ECNT_TCH0	[7:3]	Reserved		Reserved.	0x0	R
		[2:0]	ECNT_TCH0		Terminal count hold enable of error counters for Lane 0. When set, the designated counter is to hold the terminal count value of 0xFF when it is reached until the counter is reset by the user. Otherwise, the designated counter rolls over. Counters of each lane are addressed as follows: Bit 2 = UEK character error. Bit 1 = NIT. Bit 0 = BDE.  This signal must only be programmed while the QBD is held in soft reset (Register 0x475, Bit 3), and must not be changed during normal operation.	0x7	R/W
0x489	ECNT_TCH1	[7:3]	Reserved		Reserved.	0x0	R



Hex. Addr.	Register Name	Bit No.	Bit Name	Settings	Description	Reset	Access
		[2:0]	ECNT_TCH1		Terminal count hold enable of error counters for Lane 1. When set, the designated counter is to hold the terminal count value of 0xFF when it is reached until the counter is reset by the user. Otherwise, the designated counter rolls over. Counters of each lane are addressed as follows: Bit 2 = UEK character error. Bit 1 = NIT. Bit 0 = BDE. This signal must only be programmed while the QBD is held in soft reset (Register 0x475, Bit 3), and must not be changed during normal operation.	0x7	R/W
0x48A	ECNT_TCH2	[7:3]	Reserved		Reserved.	0x0	R
		[2:0]	ECNT_TCH2		Terminal count hold enable of error counters for Lane 2. When set, the designated counter is to hold the terminal count value of 0xFF when it is reached until the counter is reset by the user. Otherwise, the designated counter rolls over. Counters of each lane are addressed as follows: Bit 2 = UEK character error. Bit 1 = NIT. Bit 0 = BDE. This signal must only be programmed while the QBD is held in soft reset (Register 0x475, Bit 3), and must not be changed during normal operation.	0x7	R/W
0x48B	ECNT_TCH3	[7:3]	Reserved		Reserved.	0x0	R
		[2:0]	ECNT_TCH3		Terminal count hold enable of error counters for Lane 3. When set, the designated counter is to hold the terminal count value of 0xFF when it is reached until the counter is reset by the user. Otherwise, the designated counter rolls over. Counters of each lane are addressed as follows: Bit 2 = UEK character error. Bit 1 = NIT. Bit 0 = BDE. This signal must only be programmed while the QBD is held in soft reset (Register 0x475, Bit 3), and must not be changed during normal operation.	0x7	R/W

Hex. Addr.	Register Name	Bit No.	Bit Name	Settings	Description	Reset	Access
0x48C	ECNT_TCH4	[7:3]	Reserved		Reserved.	0x0	R
		[2:0]	ECNT_TCH4		Terminal count hold enable of error counters for Lane 4. When set, the designated counter is to hold the terminal count value of 0xFF when it is reached until the counter is reset by the user. Otherwise, the designated counter rolls over. Counters of each lane are addressed as follows: Bit 2 = UEK character error. Bit 1 = NIT. Bit 0 = BDE. This signal must only be programmed while the QBD is held in soft reset (Register 0x475, Bit 3), and must not be changed during normal operation.	0x7	R/W
0x48D	ECNT_TCH5	[7:3]	Reserved		Reserved.	0x0	R
		[2:0]	ECNT_TCH5		Terminal count hold enable of error counters for Lane 5. When set, the designated counter is to hold the terminal count value of 0xFF when it is reached until the counter is reset by the user. Otherwise, the designated counter rolls over. Counters of each lane are addressed as follows: Bit 2 = UEK character error. Bit 1 = NIT. Bit 0 = BDE. This signal must only be programmed while the QBD is held in soft reset (Register 0x475, Bit 3), and must not be changed during normal operation.	0x7	R/W
0x48E	ECNT_TCH6	[7:3]	Reserved		Reserved.	0x0	R
		[2:0]	ECNT_TCH6		Terminal count hold enable of error counters for Lane 6. When set, the designated counter is to hold the terminal count value of 0xFF when it is reached until the counter is reset by the user. Otherwise, the designated counter rolls over. Counters of each lane are addressed as follows: Bit 2 = UEK character error. Bit 1 = NIT. Bit 0 = BDE. This signal must only be programmed while the QBD is held in soft reset (Register 0x475, Bit 3), and must not be changed during normal operation.	0x7	R/W

Hex. Addr.	Register Name	Bit No.	Bit Name	Settings	Description	Reset	Access
0x48F	ECNT_TCH7	[7:3]	Reserved		Reserved.	0x0	R
		[2:0]	ECNT_TCH7		Terminal count hold enable of error counters for Lane 7. When set, the designated counter is to hold the terminal count value of 0xFF when it is reached until the counter is reset by the user. Otherwise, the designated counter rolls over. Counters of each lane are addressed as follows: Bit 2 = UEK character error. Bit 1 = NIT. Bit 0 = BDE. This signal must only be programmed while the QBD is held in soft reset (Register 0x475, Bit 3), and must not be changed during normal operation.	0x7	R/W
0x490	ECNT_STAT0	[7:4]	Reserved		Reserved.	0x0	R
		3	LANE_ENA0		This output indicates if Lane 0 is enabled. 0 Lane 0 is held in soft reset. 1 Lane 0 is enabled.	0x0	R
		[2:0]	ECNT_TCR0		Terminal count reached indicator of error counters for Lane 0. Set to 1 when the corresponding counter terminal count value of 0xFF has been reached. Counters of each lane are addressed as follows. Bit 2 = UEK character error. Bit 1 = NIT. Bit 0 = BDE.	0x0	R
0x491	ECNT_STAT1	[7:4]	Reserved		Reserved.	0x0	R
		3	LANE_ENA1		This output indicates if Lane 1 is enabled. 0 Lane 1 is held in soft reset. 1 Lane 1 is enabled.	0x0	R
		[2:0]	ECNT_TCR1		Terminal count reached indicator of error counters for Lane 1. Set to 1 when the corresponding counter terminal count value of 0xFF has been reached. Counters of each lane are addressed as follows. Bit 2 = UEK character error. Bit 1 = NIT. Bit 0 = BDE.	0x0	R
0x492	ECNT_STAT2	[7:4]	Reserved		Reserved.	0x0	R
		3	LANE_ENA2		This output indicates if Lane 2 is enabled. 0 Lane 2 is held in soft reset. 1 Lane 2 is enabled.	0x0	R

Hex. Addr.	Register Name	Bit No.	Bit Name	Settings	Description	Reset	Access
		[2:0]	ECNT_TCR2		Terminal count reached indicator of error counters for Lane 2. Set to 1 when the corresponding counter terminal count value of 0xFF has been reached. Counters of each lane are addressed as follows: Bit 2 = UEK character error. Bit 1 = NIT. Bit 0 = BDE.	0x0	R
0x493	ECNT_STAT3	[7:4]	Reserved		Reserved.	0x0	R
		3	LANE_ENA3		This output indicates if Lane 3 is enabled. 0 Lane 3 is held in soft reset. 1 Lane 3 is enabled.	0x0	R
		[2:0]	ECNT_TCR3		Terminal count reached indicator of error counters for Lane 3. Set to 1 when the corresponding counter terminal count value of 0xFF has been reached. Counters of each lane are addressed as follows: Bit 2 = UEK character error. Bit 1 = NIT. Bit 0 = BDE.	0x0	R
0x494	ECNT_STAT4	[7:4]	Reserved		Reserved.	0x0	R
		3	LANE_ENA4		This output indicates if Lane 4 is enabled. 0 Lane 4 is held in soft reset. 1 Lane 4 is enabled.	0x0	R
		[2:0]	ECNT_TCR4		Terminal count reached indicator of error counters for Lane 4. Set to 1 when the corresponding counter terminal count value of 0xFF has been reached. Counters of each lane are addressed as follows: Bit 2 = UEK character error. Bit 1 = NIT. Bit 0 = BDE.	0x0	R
0x495	ECNT_STAT5	[7:4]	Reserved		Reserved.	0x0	R
		3	LANE_ENA5		This output indicates if Lane 5 is enabled. 0 Lane 5 is held in soft reset. 1 Lane 5 is enabled.	0x0	R
		[2:0]	ECNT_TCR5		Terminal count reached indicator of error counters for Lane 5. Set to 1 when the corresponding counter terminal count value of 0xFF has been reached. Counters of each lane are addressed as follows: Bit 2 = UEK character error. Bit 1 = NIT. Bit 0 = BDE.	0x0	R

Hex. Addr.	Register Name	Bit No.	Bit Name	Settings	Description	Reset	Access
0x496	ECNT_STAT6	[7:4]	Reserved		Reserved.	0x0	R
		3	LANE_ENA6		This output indicates if Lane 6 is enabled. 0 Lane 6 is held in soft reset. 1 Lane 6 is enabled.	0x0	R
		[2:0]	ECNT_TCR6		Terminal count reached indicator of error counters for Lane 6. Set to 1 when the corresponding counter terminal count value of 0xFF has been reached. Counters of each lane are addressed as follows: Bit 2 = UEK character error. Bit 1 = NIT. Bit 0 = BDE.	0x0	R
0x497	ECNT_STAT7	[7:4]	Reserved		Reserved.	0x0	R
		3	LANE_ENA7		This output indicates if Lane 7 is enabled. 0 Lane 7 is held in soft reset. 1 Lane 7 is enabled.	0x0	R
		[2:0]	ECNT_TCR7		Terminal count reached indicator of error counters for Lane 7. Set to 1 when the corresponding counter terminal count value of 0xFF has been reached. Counters of each lane are addressed as follows: Bit 2 = UEK character error. Bit 1 = NIT. Bit 0 = BDE.	0x0	R
0x498	BD_CNT0	[7:0]	BD_CNT0		Bad disparity 8-bit error counters for Lane 0.	0x0	R
0x499	BD_CNT1	[7:0]	BD_CNT1		Bad disparity 8-bit error counters for Lane 1.	0x0	R
0x49A	BD_CNT2	[7:0]	BD_CNT2		Bad disparity 8-bit error counters for Lane 2.	0x0	R
0x49B	BD_CNT3	[7:0]	BD_CNT3		Bad disparity 8-bit error counters for Lane 3.	0x0	R
0x49C	BD_CNT4	[7:0]	BD_CNT4		Bad disparity 8-bit error counters for Lane 4.	0x0	R
0x49D	BD_CNT5	[7:0]	BD_CNT5		Bad disparity 8-bit error counters for Lane 5.	0x0	R
0x49E	BD_CNT6	[7:0]	BD_CNT6		Bad disparity 8-bit error counters for Lane 6.	0x0	R
0x49F	BD_CNT7	[7:0]	BD_CNT7		Bad disparity 8-bit error counters for Lane 7.	0x0	R
0x4A0	NIT_CNT0	[7:0]	NIT_CNT0		Bad disparity 8-bit error counters for Lane 0.	0x0	R
0x4A1	NIT_CNT1	[7:0]	NIT_CNT1		NIT 8-bit error counters for Lane 1.	0x0	R
0x4A2	NIT_CNT2	[7:0]	NIT_CNT2		NIT 8-bit error counters for Lane 2.	0x0	R
0x4A3	NIT_CNT3	[7:0]	NIT_CNT3		NIT 8-bit error counters for Lane 3.	0x0	R
0x4A4	NIT_CNT4	[7:0]	NIT_CNT4		NIT 8-bit error counters for Lane 4.	0x0	R
0x4A5	NIT_CNT5	[7:0]	NIT_CNT5		NIT 8-bit error counters for Lane 5.	0x0	R

Hex. Addr.	Register Name	Bit No.	Bit Name	Settings	Description	Reset	Access
0x4A6	NIT_CNT6	[7:0]	NIT_CNT6		NIT 8-bit error counters for Lane 6.	0x0	R
0x4A7	NIT_CNT7	[7:0]	NIT_CNT7		NIT 8-bit error counters for Lane 7.	0x0	R
0x4A8	UEK_CNT0	[7:0]	UEK_CNT0		UEK character 8-bit error counters for Lane 0.	0x0	R
0x4A9	UEK_CNT1	[7:0]	UEK_CNT1		UEK character 8-bit error counters for Lane 1.	0x0	R
0x4AA	UEK_CNT2	[7:0]	UEK_CNT2		UEK character 8-bit error counters for Lane 2.	0x0	R
0x4AB	UEK_CNT3	[7:0]	UEK_CNT3		UEK character 8-bit error counters for Lane 3.	0x0	R
0x4AC	UEK_CNT4	[7:0]	UEK_CNT4		UEK character 8-bit error counters for Lane 4.	0x0	R
0x4AD	UEK_CNT5	[7:0]	UEK_CNT5		UEK character 8-bit error counters for Lane 5.	0x0	R
0x4AE	UEK_CNT6	[7:0]	UEK_CNT6		UEK character 8-bit error counters for Lane 6.	0x0	R
0x4AF	UEK_CNT7	[7:0]	UEK_CNT7		UEK character 8-bit error counters for Lane 7.	0x0	R
0x4B0	LINK_STATUS0	7	BDE0		BDE status for Lane 0. 0 Error count < ETH[7:0] value. 1 Error count ≥ ETH[7:0] value.	0x0	R
		6	NIT0		NIT errors status for Lane 0. 0 Error count < ETH[7:0] value. 1 Error count ≥ ETH[7:0] value.	0x0	R
		5	UEK0		UEK character errors status for Lane 0. 0 Error count < ETH[7:0] value. 1 Error count ≥ ETH[7:0] value.	0x0	R
		4	ILD0		Interlane deskew status for Lane 0 (ignore this output when NO_ILAS = 1). 0 Deskew failed. 1 Deskew achieved.	0x0	R
		3	ILS0		Initial lane synchronization status for Lane 0 (ignore this output when NO_ILAS = 1). 0 Synchronization lost. 1 Synchronization achieved.	0x0	R
		2	CKS0		Computed checksum status for Lane 0 (ignore this output when NO_ILAS = 1). 0 Checksum is incorrect. 1 Checksum is correct.	0x0	R
		1	FS0		Frame sync status for Lane 0 (ignore this output when NO_ILAS = 1). 0 Synchronization lost. 1 Synchronization achieved.	0x0	R
		0	CGS0		Code group sync status for Lane 0. 0 Synchronization lost. 1 Synchronization achieved.	0x0	R
0x4B1	LINK_STATUS1	7	BDE1		BDE status for Lane 1. 0 Error count < ETH[7:0] value. 1 Error count ≥ ETH[7:0] value.	0x0	R

Hex. Addr.	Register Name	Bit No.	Bit Name	Settings	Description	Reset	Access
		6	NIT1		NIT errors status for Lane 1. 0 Error count < ETH[7:0] value. 1 Error count ≥ ETH[7:0] value.	0x0	R
		5	UEK1		UEK character errors status for Lane 1. 0 Error count < ETH[7:0] value. 1 Error count ≥ ETH[7:0] value.	0x0	R
		4	ILD1		Interlane deskew status for Lane 1 (ignore this output when NO_ILAS = 1). 0 Deskew failed. 1 Deskew achieved.	0x0	R
		3	ILS1		Initial lane synchronization status for Lane 1 (ignore this output when NO_ILAS = 1). 0 Synchronization lost. 1 Synchronization achieved.	0x0	R
		2	CKS1		Computed checksum status for Lane 1 (ignore this output when NO_ILAS = 1). 0 Checksum is incorrect. 1 Checksum is correct.	0x0	R
		1	FS1		Frame sync status for Lane 1 (ignore this output when NO_ILAS = 1). 0 Synchronization lost. 1 Synchronization achieved.	0x0	R
		0	CGS1		Code group sync status for Lane 1. 0 Synchronization lost. 1 Synchronization achieved.	0x0	R
		0x4B2	LINK_STATUS2	7	BDE2		BDE status for Lane 2. 0 Error count < ETH[7:0] value. 1 Error count ≥ ETH[7:0] value.
		6	NIT2		NIT errors status for Lane 2. 0 Error count < ETH[7:0] value. 1 Error count ≥ ETH[7:0] value.	0x0	R
		5	UEK2		UEK character errors status for Lane 2. 0 Error count < ETH[7:0] value. 1 Error count ≥ ETH[7:0] value.	0x0	R
		4	ILD2		Interlane deskew status for Lane 2 (ignore this output when NO_ILAS = 1). 0 Deskew failed. 1 Deskew achieved.	0x0	R
		3	ILS2		Initial lane synchronization status for Lane 2 (ignore this output when NO_ILAS = 1). 0 Synchronization lost. 1 Synchronization achieved.	0x0	R
		2	CKS2		Computed checksum status for Lane 2 (ignore this output when NO_ILAS = 1). 0 Checksum is incorrect. 1 Checksum is correct.	0x0	R

Hex. Addr.	Register Name	Bit No.	Bit Name	Settings	Description	Reset	Access
		1	FS2		Frame sync status for Lane 2 (ignore this output when NO_ILAS = 1). 0 Synchronization lost. 1 Synchronization achieved.	0x0	R
		0	CGS2		Code group sync status for Lane 2. 0 Synchronization lost. 1 Synchronization achieved.	0x0	R
0x4B3	LINK_STATUS3	7	BDE3		BDE status for Lane 3. 0 Error count < ETH[7:0] value. 1 Error count ≥ ETH[7:0] value.	0x0	R
		6	NIT3		NIT errors status for Lane 3. 0 Error count < ETH[7:0] value. 1 Error count ≥ ETH[7:0] value.	0x0	R
		5	UEK3		UEK character errors status for Lane 3. 0 Error count < ETH[7:0] value. 1 Error count ≥ ETH[7:0] value.	0x0	R
		4	ILD3		Interlane deskew status for Lane 3 (ignore this output when NO_ILAS = 1). 0 Deskew failed. 1 Deskew achieved.	0x0	R
		3	ILS3		Initial lane synchronization status for Lane 3 (ignore this output when NO_ILAS = 1). 0 Synchronization lost. 1 Synchronization achieved.	0x0	R
		2	CKS3		Computed checksum status for Lane 3 (ignore this output when NO_ILAS = 1). 0 Checksum is incorrect. 1 Checksum is correct.	0x0	R
		1	FS3		Frame sync status for Lane 3 (ignore this output when NO_ILAS = 1). 0 Synchronization lost. 1 Synchronization achieved.	0x0	R
		0	CGS3		Code group sync status for Lane 3. 0 Synchronization lost. 1 Synchronization achieved.	0x0	R
0x4B4	LINK_STATUS4	7	BDE4		BDE status for Lane 4. 0 Error count < ETH[7:0] value. 1 Error count ≥ ETH[7:0] value.	0x0	R
		6	NIT4		Not in table errors status for Lane 4. 0 Error count < ETH[7:0] value. 1 Error count ≥ ETH[7:0] value.	0x0	R
		5	UEK4		UEK character errors status for Lane 4. 0 Error count < ETH[7:0] value. 1 Error count ≥ ETH[7:0] value.	0x0	R



Hex. Addr.	Register Name	Bit No.	Bit Name	Settings	Description	Reset	Access
		4	ILD4		Interlane deskew status for Lane 4 (ignore this output when NO_ILAS = 1). 0 Deskew failed. 1 Deskew achieved.	0x0	R
		3	ILS4		Initial lane synchronization status for Lane 4 (ignore this output when NO_ILAS = 1). 0 Synchronization lost. 1 Synchronization achieved.	0x0	R
		2	CKS4		Computed checksum status for Lane 4 (ignore this output when NO_ILAS = 1). 0 Checksum is incorrect. 1 Checksum is correct.	0x0	R
		1	FS4		Frame sync status for Lane 4 (ignore this output when NO_ILAS = 1). 0 Synchronization lost. 1 Synchronization achieved.	0x0	R
		0	CGS4		Code group sync status for Lane 4. 0 Synchronization lost. 1 Synchronization achieved.	0x0	R
		0x4B5	LINK_STATUS5	7	BDE5		BDE status for Lane 5. 0 Error count < ETH[7:0] value. 1 Error count ≥ ETH[7:0] value.
		6	NIT5		NIT errors status for Lane 5. 0 Error count < ETH[7:0] value. 1 Error count ≥ ETH[7:0] value.	0x0	R
		5	UEK5		UEK character errors status for Lane 5. 0 Error count < ETH[7:0] value. 1 Error count ≥ ETH[7:0] value.	0x0	R
		4	ILD5		Interlane deskew status for Lane 5 (ignore this output when NO_ILAS = 1). 0 Deskew failed. 1 Deskew achieved.	0x0	R
		3	ILS5		Initial lane synchronization status for Lane 5 (ignore this output when NO_ILAS = 1). 0 Synchronization lost. 1 Synchronization achieved.	0x0	R
		2	CKS5		Computed checksum status for Lane 5 (ignore this output when NO_ILAS = 1). 0 Checksum is incorrect. 1 Checksum is correct.	0x0	R
		1	FS5		Frame sync status for Lane 5 (ignore this output when NO_ILAS = 1). 0 Synchronization lost. 1 Synchronization achieved.	0x0	R
		0	CGS5		Code group sync status for Lane 5. 0 Synchronization lost. 1 Synchronization achieved.	0x0	R

Hex. Addr.	Register Name	Bit No.	Bit Name	Settings	Description	Reset	Access
0x4B6	LINK_STATUS6	7	BDE6		BDE status for Lane 6. 0 Error count < ETH[7:0] value. 1 Error count ≥ ETH[7:0] value.	0x0	R
		6	NIT6		NIT errors status for Lane 6. 0 Error count < ETH[7:0] value. 1 Error count ≥ ETH[7:0] value.	0x0	R
		5	UEK6		UEK character errors status for Lane 6. 0 Error count < ETH[7:0] value. 1 Error count ≥ ETH[7:0] value.	0x0	R
		4	ILD6		Interlane deskew status for Lane 6 (ignore this output when NO_ILAS = 1). 0 Deskew failed. 1 Deskew achieved.	0x0	R
		3	ILS6		Initial lane synchronization status for Lane 6 (ignore this output when NO_ILAS = 1). 0 Synchronization lost. 1 Synchronization achieved.	0x0	R
		2	CKS6		Computed checksum status for Lane 6 (ignore this output when NO_ILAS = 1). 0 Checksum is incorrect. 1 Checksum is correct.	0x0	R
		1	FS6		Frame sync status for Lane 6 (ignore this output when NO_ILAS = 1). 0 Synchronization lost. 1 Synchronization achieved.	0x0	R
		0	CGS6		Code group sync status for Lane 6. 0 Synchronization lost. 1 Synchronization achieved.	0x0	R
0x4B7	LINK_STATUS7	7	BDE7		BDE status for Lane 7. 0 Error count < ETH[7:0] value. 1 Error count ≥ ETH[7:0] value.	0x0	R
		6	NIT7		NIT errors status for Lane 7. 0 Error count < ETH[7:0] value. 1 Error count ≥ ETH[7:0] value.	0x0	R
		5	UEK7		UEK character errors status for Lane 7. 0 Error count < ETH[7:0] value. 1 Error count ≥ ETH[7:0] value.	0x0	R
		4	ILD7		Interlane deskew status for Lane 7 (ignore this output when NO_ILAS = 1). 0 Deskew failed. 1 Deskew achieved.	0x0	R
		3	ILS7		Initial lane synchronization status for Lane 7 (ignore this output when NO_ILAS = 1). 0 Synchronization lost. 1 Synchronization achieved.	0x0	R

Hex. Addr.	Register Name	Bit No.	Bit Name	Settings	Description	Reset	Access
		2	CKS7		Computed checksum status for Lane 7 (ignore this output when NO_ILAS = 1). 0 Checksum is incorrect. 1 Checksum is correct.	0x0	R
		1	FS7		Frame sync status for Lane 7 (ignore this output when NO_ILAS = 1). 0 Synchronization lost. 1 Synchronization achieved.	0x0	R
		0	CGS7		Code group sync status for Lane 7. 0 Synchronization lost. 1 Synchronization achieved.	0x0	R
0x4B8	JESD_IRQ_ENABLEA	7	EN_BDE		BDE counter.	0x0	R/W
		6	EN_NIT		NIT error counter.	0x0	R/W
		5	EN_UEK		UEK error counter.	0x0	R/W
		4	EN_ILD		Interlane deskew.	0x0	R/W
		3	EN_ILS		Initial lane sync.	0x0	R/W
		2	EN_CKS		Good checksum. This is an interrupt that compares two checksums: the checksum that the transmitter sent over the link during the ILAS, and the checksum that the receiver calculated from the ILAS data that the transmitter sent over the link. The checksum IRQ never at any time looks at the checksum that is programmed over the SPI into Register 0x45D. The checksum IRQ only looks at the data sent by the transmitter, and never looks at any data programmed via the SPI.	0x0	R/W
		1	EN_FS		Frame sync.	0x0	R/W
		0	EN_CGS		Code group sync.	0x0	R/W
0x4B9	JESD_IRQ_ENABLEB	[7:1]	Reserved		Reserved.	0x0	R
		0	EN_ILAS		Configuration mismatch (checked for Lane 0 only). The ILAS IRQ compares the two sets of ILAS data that the receiver has: the ILAS data sent over the JESD204B link by the transmitter, and the ILAS data programmed into the receiver via the SPI (Register 0x450 to Register 0x45D). If the data differs, the IRQ is triggered. Note that all of the ILAS data (including the checksum) is compared.	0x0	R/W
0x4BA	JESD_IRQ_STATUSA	7	IRQ_BDE		BDE counter.	0x0	R/W
		6	IRQ_NIT		NIT error counter.	0x0	R/W
		5	IRQ_UEK		UEK error counter.	0x0	R/W
		4	IRQ_ILD		Interlane deskew.	0x0	R/W
		3	IRQ_ILS		Initial lane sync.	0x0	R/W
		2	IRQ_CKS		Good checksum.	0x0	R/W
		1	IRQ_FS		Frame sync.	0x0	R/W
		0	IRQ_CGS		Code group sync.	0x0	R/W

Hex. Addr.	Register Name	Bit No.	Bit Name	Settings	Description	Reset	Access
0x4BB	JESD_IRQ_STATUSB	[7:1]	Reserved		Reserved.	0x0	R
		0	IRQ_ILAS		Configuration mismatch (checked for Lane 0 only).	0x0	R/W
0x800	HOPF_CTRL	[7:6]	HOPF_MODE		Frequency switch (hop) mode. Defines the phase relation when a new frequency is hopped to. 00 Phase continuous switch. Changes frequency tuning word, and the phase accumulator continues to accumulate to the new FTW. 01 Phase discontinuous switch. Changes the frequency tuning word and resets the phase accumulator. 10 Phase coherent switch. FTW is selected from one of the 32 hopping FTWs. Frequency changes are phase discontinuous from one frequency to another but changes back to a previous frequency and retains the phase accumulation of the previous frequency.	0x0	R/W
		5	Reserved		Reserved.	0x0	R
		[4:0]	HOPF_SEL		Hopping frequency selection control. Enter the number of the FTW to select the output of that NCO.	0x0	R/W
0x806	HOPF_FTW1_0	[7:0]	HOPF_FTW1[7:0]		Hopping frequency FTW1.	0x0	R/W
0x807	HOPF_FTW1_1	[7:0]	HOPF_FTW1[15:8]		Hopping frequency FTW1.	0x0	R/W
0x808	HOPF_FTW1_2	[7:0]	HOPF_FTW1[23:16]		Hopping frequency FTW1	0x0	R/W
0x809	HOPF_FTW1_3	[7:0]	HOPF_FTW1[31:24]		Hopping frequency FTW1	0x0	R/W
0x80A	HOPF_FTW2_0	[7:0]	HOPF_FTW2[7:0]		Hopping frequency FTW2	0x0	R/W
0x80B	HOPF_FTW2_1	[7:0]	HOPF_FTW2[15:8]		Hopping frequency FTW2	0x0	R/W
0x80C	HOPF_FTW2_2	[7:0]	HOPF_FTW2[23:16]		Hopping frequency FTW2	0x0	R/W
0x80D	HOPF_FTW2_3	[7:0]	HOPF_FTW2[31:24]		Hopping frequency FTW2	0x0	R/W
0x80E	HOPF_FTW3_0	[7:0]	HOPF_FTW3[7:0]		Hopping frequency FTW3	0x0	R/W
0x80F	HOPF_FTW3_1	[7:0]	HOPF_FTW3[15:8]		Hopping frequency FTW3	0x0	R/W
0x810	HOPF_FTW3_2	[7:0]	HOPF_FTW3[23:16]		Hopping frequency FTW3	0x0	R/W
0x811	HOPF_FTW3_3	[7:0]	HOPF_FTW3[31:24]		Hopping frequency FTW3	0x0	R/W
0x812	HOPF_FTW4_0	[7:0]	HOPF_FTW4[7:0]		Hopping frequency FTW4	0x0	R/W
0x813	HOPF_FTW4_1	[7:0]	HOPF_FTW4[15:8]		Hopping frequency FTW4	0x0	R/W
0x814	HOPF_FTW4_2	[7:0]	HOPF_FTW4[23:16]		Hopping frequency FTW4	0x0	R/W
0x815	HOPF_FTW4_3	[7:0]	HOPF_FTW4[31:24]		Hopping frequency FTW4	0x0	R/W
0x816	HOPF_FTW5_0	[7:0]	HOPF_FTW5[7:0]		Hopping frequency FTW5	0x0	R/W
0x817	HOPF_FTW5_1	[7:0]	HOPF_FTW5[15:8]		Hopping frequency FTW5	0x0	R/W
0x818	HOPF_FTW5_2	[7:0]	HOPF_FTW5[23:16]		Hopping frequency FTW5	0x0	R/W
0x819	HOPF_FTW5_3	[7:0]	HOPF_FTW5[31:24]		Hopping frequency FTW5	0x0	R/W
0x81A	HOPF_FTW6_0	[7:0]	HOPF_FTW6[7:0]		Hopping frequency FTW6	0x0	R/W
0x81B	HOPF_FTW6_1	[7:0]	HOPF_FTW6[15:8]		Hopping frequency FTW6	0x0	R/W
0x81C	HOPF_FTW6_2	[7:0]	HOPF_FTW6[23:16]		Hopping frequency FTW6	0x0	R/W
0x81D	HOPF_FTW6_3	[7:0]	HOPF_FTW6[31:24]		Hopping frequency FTW6	0x0	R/W
0x81E	HOPF_FTW7_0	[7:0]	HOPF_FTW7[7:0]		Hopping frequency FTW7	0x0	R/W
0x81F	HOPF_FTW7_1	[7:0]	HOPF_FTW7[15:8]		Hopping frequency FTW7	0x0	R/W
0x820	HOPF_FTW7_2	[7:0]	HOPF_FTW7[23:16]		Hopping frequency FTW7	0x0	R/W

Hex. Addr.	Register Name	Bit No.	Bit Name	Settings	Description	Reset	Access
0x821	HOPF_FTW7_3	[7:0]	HOPF_FTW7[31:24]		Hopping frequency FTW7	0x0	R/W
0x822	HOPF_FTW8_0	[7:0]	HOPF_FTW8[7:0]		Hopping frequency FTW8	0x0	R/W
0x823	HOPF_FTW8_1	[7:0]	HOPF_FTW8[15:8]		Hopping frequency FTW8	0x0	R/W
0x824	HOPF_FTW8_2	[7:0]	HOPF_FTW8[23:16]		Hopping frequency FTW8	0x0	R/W
0x825	HOPF_FTW8_3	[7:0]	HOPF_FTW8[31:24]		Hopping frequency FTW8	0x0	R/W
0x826	HOPF_FTW9_0	[7:0]	HOPF_FTW9[7:0]		Hopping frequency FTW9	0x0	R/W
0x827	HOPF_FTW9_1	[7:0]	HOPF_FTW9[15:8]		Hopping frequency FTW9	0x0	R/W
0x828	HOPF_FTW9_2	[7:0]	HOPF_FTW9[23:16]		Hopping frequency FTW9	0x0	R/W
0x829	HOPF_FTW9_3	[7:0]	HOPF_FTW9[31:24]		Hopping frequency FTW9	0x0	R/W
0x82A	HOPF_FTW10_0	[7:0]	HOPF_FTW10[7:0]		Hopping frequency FTW10	0x0	R/W
0x82B	HOPF_FTW10_1	[7:0]	HOPF_FTW10[15:8]		Hopping frequency FTW10	0x0	R/W
0x82C	HOPF_FTW10_2	[7:0]	HOPF_FTW10[23:16]		Hopping frequency FTW10	0x0	R/W
0x82D	HOPF_FTW10_3	[7:0]	HOPF_FTW10[31:24]		Hopping frequency FTW10	0x0	R/W
0x82E	HOPF_FTW11_0	[7:0]	HOPF_FTW11[7:0]		Hopping frequency FTW11	0x0	R/W
0x82F	HOPF_FTW11_1	[7:0]	HOPF_FTW11[15:8]		Hopping frequency FTW11	0x0	R/W
0x830	HOPF_FTW11_2	[7:0]	HOPF_FTW11[23:16]		Hopping frequency FTW11	0x0	R/W
0x831	HOPF_FTW11_3	[7:0]	HOPF_FTW11[31:24]		Hopping frequency FTW11	0x0	R/W
0x832	HOPF_FTW12_0	[7:0]	HOPF_FTW12[7:0]		Hopping frequency FTW12	0x0	R/W
0x833	HOPF_FTW12_1	[7:0]	HOPF_FTW12[15:8]		Hopping frequency FTW12	0x0	R/W
0x834	HOPF_FTW12_2	[7:0]	HOPF_FTW12[23:16]		Hopping frequency FTW12	0x0	R/W
0x835	HOPF_FTW12_3	[7:0]	HOPF_FTW12[31:24]		Hopping frequency FTW12	0x0	R/W
0x836	HOPF_FTW13_0	[7:0]	HOPF_FTW13[7:0]		Hopping frequency FTW13	0x0	R/W
0x837	HOPF_FTW13_1	[7:0]	HOPF_FTW13[15:8]		Hopping frequency FTW13	0x0	R/W
0x838	HOPF_FTW13_2	[7:0]	HOPF_FTW13[23:16]		Hopping frequency FTW13	0x0	R/W
0x839	HOPF_FTW13_3	[7:0]	HOPF_FTW13[31:24]		Hopping frequency FTW13	0x0	R/W
0x83A	HOPF_FTW14_0	[7:0]	HOPF_FTW14[7:0]		Hopping frequency FTW14	0x0	R/W
0x83B	HOPF_FTW14_1	[7:0]	HOPF_FTW14[15:8]		Hopping frequency FTW14	0x0	R/W
0x83C	HOPF_FTW14_2	[7:0]	HOPF_FTW14[23:16]		Hopping frequency FTW14	0x0	R/W
0x83D	HOPF_FTW14_3	[7:0]	HOPF_FTW14[31:24]		Hopping frequency FTW14	0x0	R/W
0x83E	HOPF_FTW15_0	[7:0]	HOPF_FTW15[7:0]		Hopping frequency FTW15	0x0	R/W
0x83F	HOPF_FTW15_1	[7:0]	HOPF_FTW15[15:8]		Hopping frequency FTW15	0x0	R/W
0x840	HOPF_FTW15_2	[7:0]	HOPF_FTW15[23:16]		Hopping frequency FTW15	0x0	R/W
0x841	HOPF_FTW15_3	[7:0]	HOPF_FTW15[31:24]		Hopping frequency FTW15	0x0	R/W
0x842	HOPF_FTW16_0	[7:0]	HOPF_FTW16[7:0]		Hopping frequency FTW16	0x0	R/W
0x843	HOPF_FTW16_1	[7:0]	HOPF_FTW16[15:8]		Hopping frequency FTW16	0x0	R/W
0x844	HOPF_FTW16_2	[7:0]	HOPF_FTW16[23:16]		Hopping frequency FTW16	0x0	R/W
0x845	HOPF_FTW16_3	[7:0]	HOPF_FTW16[31:24]		Hopping frequency FTW16	0x0	R/W
0x846	HOPF_FTW17_0	[7:0]	HOPF_FTW17[7:0]		Hopping frequency FTW17	0x0	R/W
0x847	HOPF_FTW17_1	[7:0]	HOPF_FTW17[15:8]		Hopping frequency FTW17	0x0	R/W
0x848	HOPF_FTW17_2	[7:0]	HOPF_FTW17[23:16]		Hopping frequency FTW17	0x0	R/W
0x849	HOPF_FTW17_3	[7:0]	HOPF_FTW17[31:24]		Hopping frequency FTW17	0x0	R/W
0x84A	HOPF_FTW18_0	[7:0]	HOPF_FTW18[7:0]		Hopping frequency FTW18	0x0	R/W
0x84B	HOPF_FTW18_1	[7:0]	HOPF_FTW18[15:8]		Hopping frequency FTW18	0x0	R/W
0x84C	HOPF_FTW18_2	[7:0]	HOPF_FTW18[23:16]		Hopping frequency FTW18	0x0	R/W
0x84D	HOPF_FTW18_3	[7:0]	HOPF_FTW18[31:24]		Hopping frequency FTW18	0x0	R/W
0x84E	HOPF_FTW19_0	[7:0]	HOPF_FTW19[7:0]		Hopping frequency FTW19	0x0	R/W
0x84F	HOPF_FTW19_1	[7:0]	HOPF_FTW19[15:8]		Hopping frequency FTW19	0x0	R/W
0x850	HOPF_FTW19_2	[7:0]	HOPF_FTW19[23:16]		Hopping frequency FTW19	0x0	R/W
0x851	HOPF_FTW19_3	[7:0]	HOPF_FTW19[31:24]		Hopping frequency FTW19	0x0	R/W
0x852	HOPF_FTW20_0	[7:0]	HOPF_FTW20[7:0]		Hopping frequency FTW20	0x0	R/W
0x853	HOPF_FTW20_1	[7:0]	HOPF_FTW20[15:8]		Hopping frequency FTW20	0x0	R/W
0x854	HOPF_FTW20_2	[7:0]	HOPF_FTW20[23:16]		Hopping frequency FTW20	0x0	R/W
0x855	HOPF_FTW20_3	[7:0]	HOPF_FTW20[31:24]		Hopping frequency FTW20	0x0	R/W

Hex. Addr.	Register Name	Bit No.	Bit Name	Settings	Description	Reset	Access
0x856	HOPF_FTW21_0	[7:0]	HOPF_FTW21[7:0]		Hopping frequency FTW21	0x0	R/W
0x857	HOPF_FTW21_1	[7:0]	HOPF_FTW21[15:8]		Hopping frequency FTW21	0x0	R/W
0x858	HOPF_FTW21_2	[7:0]	HOPF_FTW21[23:16]		Hopping frequency FTW21	0x0	R/W
0x859	HOPF_FTW21_3	[7:0]	HOPF_FTW21[31:24]		Hopping frequency FTW21	0x0	R/W
0x85A	HOPF_FTW22_0	[7:0]	HOPF_FTW22[7:0]		Hopping frequency FTW22	0x0	R/W
0x85B	HOPF_FTW22_1	[7:0]	HOPF_FTW22[15:8]		Hopping frequency FTW22	0x0	R/W
0x85C	HOPF_FTW22_2	[7:0]	HOPF_FTW22[23:16]		Hopping frequency FTW22	0x0	R/W
0x85D	HOPF_FTW22_3	[7:0]	HOPF_FTW22[31:24]		Hopping frequency FTW22	0x0	R/W
0x85E	HOPF_FTW23_0	[7:0]	HOPF_FTW23[7:0]		Hopping frequency FTW23	0x0	R/W
0x85F	HOPF_FTW23_1	[7:0]	HOPF_FTW23[15:8]		Hopping frequency FTW23	0x0	R/W
0x860	HOPF_FTW23_2	[7:0]	HOPF_FTW23[23:16]		Hopping frequency FTW23	0x0	R/W
0x861	HOPF_FTW23_3	[7:0]	HOPF_FTW23[31:24]		Hopping frequency FTW23	0x0	R/W
0x862	HOPF_FTW24_0	[7:0]	HOPF_FTW24[7:0]		Hopping frequency FTW24	0x0	R/W
0x863	HOPF_FTW24_1	[7:0]	HOPF_FTW24[15:8]		Hopping frequency FTW24	0x0	R/W
0x864	HOPF_FTW24_2	[7:0]	HOPF_FTW24[23:16]		Hopping frequency FTW24	0x0	R/W
0x865	HOPF_FTW24_3	[7:0]	HOPF_FTW24[31:24]		Hopping frequency FTW24	0x0	R/W
0x866	HOPF_FTW25_0	[7:0]	HOPF_FTW25[7:0]		Hopping frequency FTW25	0x0	R/W
0x867	HOPF_FTW25_1	[7:0]	HOPF_FTW25[15:8]		Hopping frequency FTW25	0x0	R/W
0x868	HOPF_FTW25_2	[7:0]	HOPF_FTW25[23:16]		Hopping frequency FTW25	0x0	R/W
0x869	HOPF_FTW25_3	[7:0]	HOPF_FTW25[31:24]		Hopping frequency FTW25	0x0	R/W
0x86A	HOPF_FTW26_0	[7:0]	HOPF_FTW26[7:0]		Hopping frequency FTW26	0x0	R/W
0x86B	HOPF_FTW26_1	[7:0]	HOPF_FTW26[15:8]		Hopping frequency FTW26	0x0	R/W
0x86C	HOPF_FTW26_2	[7:0]	HOPF_FTW26[23:16]		Hopping frequency FTW26	0x0	R/W
0x86D	HOPF_FTW26_3	[7:0]	HOPF_FTW26[31:24]		Hopping frequency FTW26	0x0	R/W
0x86E	HOPF_FTW27_0	[7:0]	HOPF_FTW27[7:0]		Hopping frequency FTW27	0x0	R/W
0x86F	HOPF_FTW27_1	[7:0]	HOPF_FTW27[15:8]		Hopping frequency FTW27	0x0	R/W
0x870	HOPF_FTW27_2	[7:0]	HOPF_FTW27[23:16]		Hopping frequency FTW27	0x0	R/W
0x871	HOPF_FTW27_3	[7:0]	HOPF_FTW27[31:24]		Hopping frequency FTW27	0x0	R/W
0x872	HOPF_FTW28_0	[7:0]	HOPF_FTW28[7:0]		Hopping frequency FTW28	0x0	R/W
0x873	HOPF_FTW28_1	[7:0]	HOPF_FTW28[15:8]		Hopping frequency FTW28	0x0	R/W
0x874	HOPF_FTW28_2	[7:0]	HOPF_FTW28[23:16]		Hopping frequency FTW28	0x0	R/W
0x875	HOPF_FTW28_3	[7:0]	HOPF_FTW28[31:24]		Hopping frequency FTW28	0x0	R/W
0x876	HOPF_FTW29_0	[7:0]	HOPF_FTW29[7:0]		Hopping frequency FTW29	0x0	R/W
0x877	HOPF_FTW29_1	[7:0]	HOPF_FTW29[15:8]		Hopping frequency FTW29	0x0	R/W
0x878	HOPF_FTW29_2	[7:0]	HOPF_FTW29[23:16]		Hopping frequency FTW29	0x0	R/W
0x879	HOPF_FTW29_3	[7:0]	HOPF_FTW29[31:24]		Hopping frequency FTW29	0x0	R/W
0x87A	HOPF_FTW30_0	[7:0]	HOPF_FTW30[7:0]		Hopping frequency FTW30	0x0	R/W
0x87B	HOPF_FTW30_1	[7:0]	HOPF_FTW30[15:8]		Hopping frequency FTW30	0x0	R/W
0x87C	HOPF_FTW30_2	[7:0]	HOPF_FTW30[23:16]		Hopping frequency FTW30	0x0	R/W
0x87D	HOPF_FTW30_3	[7:0]	HOPF_FTW30[31:24]		Hopping frequency FTW30	0x0	R/W
0x87E	HOPF_FTW31_0	[7:0]	HOPF_FTW31[7:0]		Hopping frequency FTW31	0x0	R/W
0x87F	HOPF_FTW31_1	[7:0]	HOPF_FTW31[15:8]		Hopping frequency FTW31	0x0	R/W
0x880	HOPF_FTW31_2	[7:0]	HOPF_FTW31[23:16]		Hopping frequency FTW31	0x0	R/W
0x881	HOPF_FTW31_3	[7:0]	HOPF_FTW31[31:24]		Hopping frequency FTW31	0x0	R/W

## REGISTER SUMMARY: AMPLIFIER

Table 47. Amplifier Register Summary

Reg	Name	Bits	Bit 7	Bit 6	Bit 5	Bit 4	Bit 3	Bit 2	Bit 1	Bit 0	Reset	RW
0x00	SPI_INTFCONFA	[7:0]	SOFTRESET_M	LSBFIRST_M	ADDRINC_M	SDOACTIVE_M	SDOACTIVE	ADDRINC	LSBFIRST	SOFTRESET	0x00	R/W
0x01	SPI_INTFCONFB	[7:0]	SINGLEINS	CSSTALL	RESERVED			SOFTRESET1	SOFTRESET0	RESERVED	0x00	R/W
0x03	SPI_CHIPTYPE	[7:0]	CHIP_TYPE								0x01	R
0x04	SPI_PRODARIANT0	[7:0]	PROD_VARIANT0								0x33	R
0x05	SPI_PRODARIANT1	[7:0]	PROD_VARIANT1								0xD5	R
0x06	SPI_PRODREV	[7:0]	PROD_REV								0x8C	R
0x0A	SPI_SCRATCHPAD	[7:0]	SCRATCHPAD								0x00	R/W
0x10	POWERDOWN	[7:0]	RESERVED	PD_NMIRROR	PD_PMIRROR	PD_CMDACCURENT	RESERVED	PD_BG	PD_ADCLOCK	0x39	R/W	
0x18	TRIM_CM	[7:0]	RESERVED				AMP_ICM				0x00	R/W
0x19	DCOUTPUTVOLTAGE	[7:0]	VOUT_TRIM								0xA0	R/W
0x1B	ADC_START	[7:0]	RESERVED						ST_ADC_CLKF_1	ST_ADC_CLKF_0	0x00	R/W
0x1C	ADC_EOC	[7:0]	RESERVED							ADC_EOC	0x01	R
0x1D	ADC_RESULTS	[7:0]	ADC_CODE								0xBD	R

## REGISTER DETAILS: AMPLIFIER REGISTER MAP

Table 48. Amplifier Register Details

Addr	Name	Bits	Bit Name	Settings	Description	Reset	Access
0x00	SPI_INTFCONFA	7	SOFTRESET_M		Soft reset (mirror) Set this to mirror Bit 0.	0x0	R
		6	LSBFIRST_M		LSB first (mirror) Set this to mirror Bit 1.	0x0	R
		5	ADDRINC_M		Address Increment (mirror) Set this to mirror Bit 2.	0x0	R
		4	SDOACTIVE_M		SDO active (mirror) Set this to mirror Bit 3.	0x0	R
		3	SDOACTIVE		SDO active. Enables 4-wire SPI bus mode.	0x0	R/W
		2	ADDRINC		Address Increment. When set, causes incrementing of streaming addresses. Otherwise, descending addresses are generated. 1 Streaming addresses are incremented. 0 Streaming addresses are decremented.	0x0	R/W
		1	LSBFIRST		LSB first. When set, causes input and output data to be oriented as LSB first. If this bit is clear, data is oriented as MSB first. 1 Shift LSB in first. 0 Shift MSB in First.	0x0	R/W
		0	SOFTRESET		Soft reset. This bit automatically clears to 0 after performing a reset operation. Setting this bit initiates a reset. This bit is autoclearing after the soft reset is complete. 1 Pulse the soft reset line. 0 Reset the soft reset line.	0x0	R/W
0x01	SPI_INTFCONFB	7	SINGLEINS		Single instruction. 1 Perform single transfers. 0 Perform multiple transfers.	0x0	R/W
		6	$\overline{\text{CS}}\text{STALL}$		$\overline{\text{CS}}_x$ stalling. 0 Disable $\overline{\text{CS}}_x$ stalling. 1 Enable $\overline{\text{CS}}_x$ stalling.	0x0	R/W
		[5:3]	RESERVED		Reserved.	0x0	R
		2	SOFTRESET1		Soft Reset 1. This bit automatically clears to 0 after performing a reset operation. 1 Pulse the Soft Reset 1 line. 0 Pulse the Soft Reset 1 line.	0x0	R/W
		1	SOFTRESET0		Soft Reset 0. This bit automatically clears to 0 after performing a reset operation. 1 Pulse the Soft Reset 0 line. 0 Pulse the Soft Reset 0 line.	0x0	R/W
		0	RESERVED		Reserved.	0x0	R
0x03	SPI_CHIPTYPE	[7:0]	CHIP_TYPE		Chip type.	0x01	R
0x04	SPI_PRODARIANT0	[7:0]	PROD_VARIANT0		Product variant.	0x33	R
0x05	SPI_PRODARIANT1	[7:0]	PROD_VARIANT1		Product variant.	0xD5	R
0x06	SPI_PRODREV	[7:0]	PROD_REV		Revision of the product variant.	0x8C	R
0x0A	SPI_SCRATCHPAD	[7:0]	SCRATCHPAD		Scratch pad R/W register.	0x0	R/W
0x10	POWERDOWN	[7:6]	RESERVED		Reserved.	0x0	R/W
		5	PD_NMIRROR		Force 1/10 nominal bias current in output stage. 1 Power down. 0 Normal functioning.	0x1	R/W
		4	PD_PMIRROR		Force 1/10 nominal bias current in input stage. 1 Power down. 0 Normal functioning	0x1	R/W



Addr	Name	Bits	Bit Name	Settings	Description	Reset	Access
		3	PD_CMDACCURRENT	1 Power down. 0 Normal functioning.	Force the DAC common-mode current to minimum	0x1	R/W
		2	RESERVED		Reserved.	0x0	R/W
		1	PD_BG	1 Power down. 0 Normal functioning.	Power down band gap and amplifier bias. Removes bias to the ADC, and the input and output stages.	0x0	R/W
		0	PD_ADCCLOCK	1 Power down. 0 Normal functioning.	Power down ADC clock.	0x1	R/W
0x18	TRIM_CM	[7:4]	RESERVED		Reserved.	0x0	R
		[3:0]	AMP_ICM		Sets the input common-mode current ( $I_{CM}$ ) of the amplifier. To minimize common-mode voltage ( $V_{CM}$ ) offset at the DAC output, set $I_{CM}$ to the nearest setting (AMP_ICM, Bits[3:0]) that corresponds to the full-scale current setting of the DAC (ANA_FULL_SCALE_CURRENT, Bits[9:0], Register 0x42 and Register 0x41). $I_{CM} = (30.4 - 6.4) \times AMP\_ICM / 15 + 6.4 \text{ mA}$	0x0	R/W
0x19	DCOUTPUTVOLTAGE	[7:0]	VOUT_TRIM		Adjusts the dc offset of the RF output ( $V_{OS\_ADJ}$ ). $V_{OS\_ADJ} = 0.6 \text{ V} \times VOUT\_TRIM / 255 - 0.25$	0xA0	R/W
0x1B	ADC_START	[7:2]	RESERVED		Reserved.	0x0	R
		1	ST_ADC_CLKF_1	0 2 MHz. 1 250 kHz.	Select the ADC clock frequency ( $f_s$ ).	0x0	
		0	ST_ADC_CLKF_0		Set high to start ADC conversion, which takes approximately 17 ADC clock cycles. End of conversion is indicated by ADC_EOC, Bit 0.	0x0	R/W
0x1C	ADC_EOC	[7:1]	RESERVED		Reserved.	0x0	R
		0	ADC_EOC	0 ADC conversion is in progress. 1 ADC conversion is finished.	ADC end of conversion flag. A 0 indicates an ADC conversion is in progress, if triggered earlier by setting the ADC_START, Bit 0.	0x1	R
0x1D	ADC_RESULTS	[7:0]	ADC_CODE		ADC output code (sample) at the end of an ADC conversion cycle. An ADC conversion cycle can be initiated by setting ADC_START, Bit 0 = high. The ADC code can be read at the end of a conversion cycle (indicated by ADC_EOC, Bit 0 = high). The ADC is sampling an input voltage ( $V_{ADC}$ ), measured at the output of an analog mux, which is connected to the junction temperature sensor. $V_{ADC} = V_{BGA} \times ADC\_CODE / 255$ where $V_{BGA} = 1.09 \text{ V}$ nominally. $V_{BG}$ varies between devices, leading to measurement uncertainty. The variation is $\pm 30 \text{ mV}$ over process, voltage (supply), and temperature (PVT). $V_{BGA}$ can be measured at the AMP_VBG pin.	0xBD	R

OUTLINE DIMENSIONS

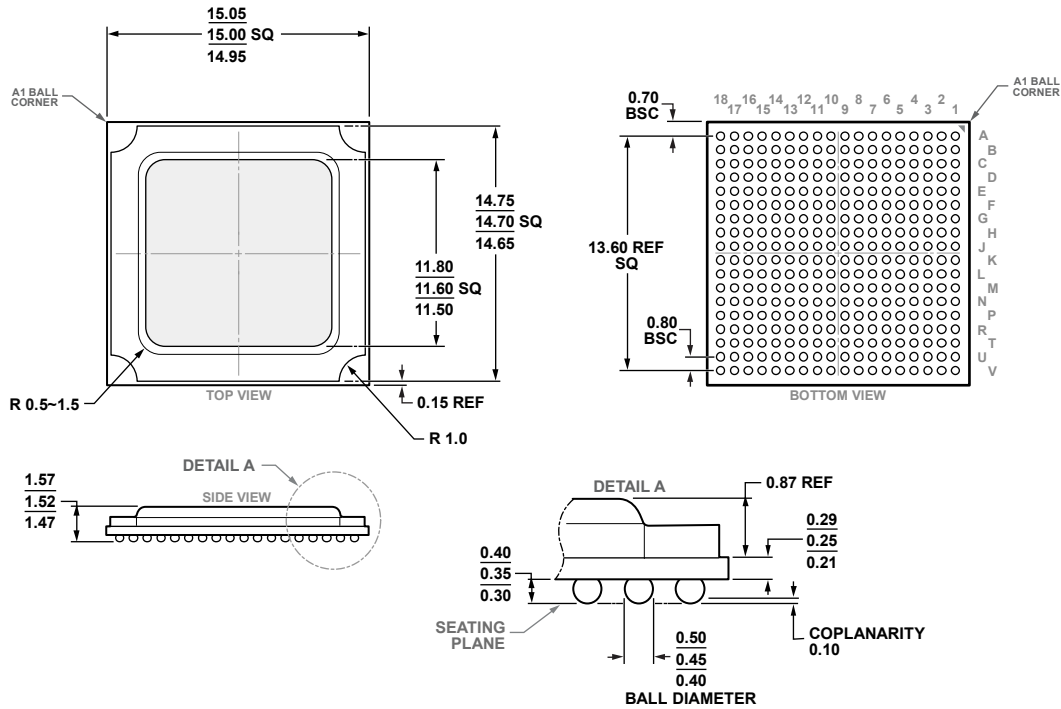

Figure 96. 324-Ball Ball Grid Array, Thermally Enhanced [BGA\_ED]  
(BP-324-1)  
Dimensions shown in millimeters

ORDERING GUIDE

Model <sup>1</sup>	Temperature Range	Package Description	Package Option
AD9166BBPZ	-40°C to +85°C	324-Ball Ball Grid Array, Thermally Enhanced [BGA_ED]	BP-324-1
AD9166BBPZRL	-40°C to +85°C	324-Ball Ball Grid Array, Thermally Enhanced [BGA_ED]	BP-324-1
AD9166-FMC-EBZ		Evaluation Board	

<sup>1</sup> Z = RoHS Compliant part.