

Description

The AP6714 is fully integrated synchronous current mode boost converter which provides a complete power supply solution for all one-cell, two-cell, three cell, alkaline, NiCd or NiMh or single-cell Lithion battery powered products. They improve performance, component count and size compared to conventional controllers, lithium-ion (Li+) designs. On-chip MOSFETs provide up to 94% efficiency for critical power supplies. This optimizes overall efficiency and cost, while also reducing board space. Operate at one fixed frequency of 1.8MHz to optimize size, cost, and efficiency. Other features include soft-start and overload protection. AP6714 is available in space-saving 10-pin MSOP package.

Features

- 94% Efficient Step-Up DC to DC Converter
- Wide Input Range 0.9V to 5.5V
- 1.8V to 5.5V Adjustable Output Voltage
- 1.8MHz Operating Frequency
- Current Mode Operation for faster transient response and better loop stability
- 1µA Shutdown Mode
- Suitable with Low ESR Ceramic Capacitors (MLCC)
- Over Current Protection
- Over Temperature Protection
- MSOP-10L: Available in "Green" Molding Compound (No Br, Sb)
- Lead Free Finish/ RoHS Compliant (Note 1)

Pin Assignments

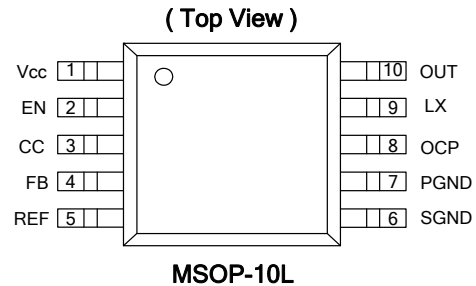

Applications

- All One-cell, Two-cell, Three cell, Alkaline, NiCd or NiMh or Single-cell Li+ Battery Powered Devices.
- Cell Phones
- Digital Cameras
- MP3 Players
- PDAs

Typical Application Circuit (Note 2)

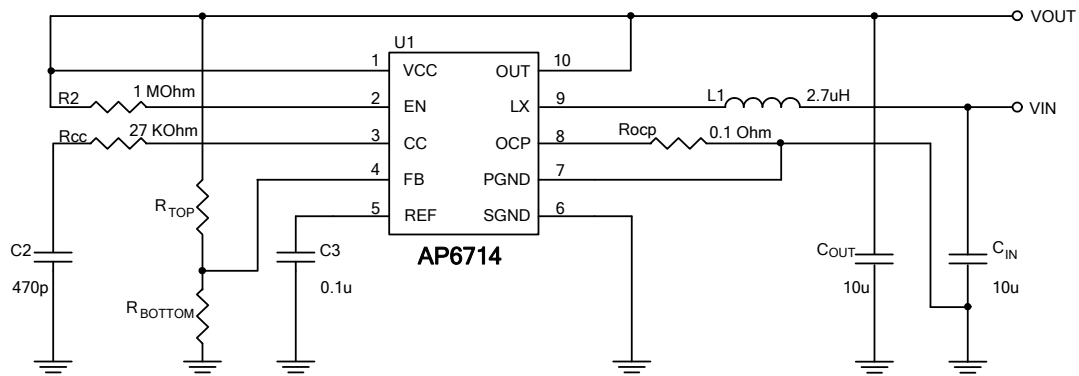

Notes: 1. EU Directive 2002/95/EC (RoHS). All applicable RoHS exemptions applied, see EU Directive 2002/95/EC Annex Notes.
2. Recommended minimum R_{BOTTOM}: 100 KΩ.

Pin Descriptions

Pin Name	Pin #	Description
V _{CC}	1	Power Input pin
EN	2	Enable Channel
CC	3	Channel Compensation Pin
FB	4	Channel Feedback Pin
REF	5	Internal Reference Voltage
SGND	6	Signal Ground
PGND	7	Power Ground
OCP	8	Over Current Protection
LX	9	SW Pin
OUT	10	Boost Output Pin

Functional Block Diagram

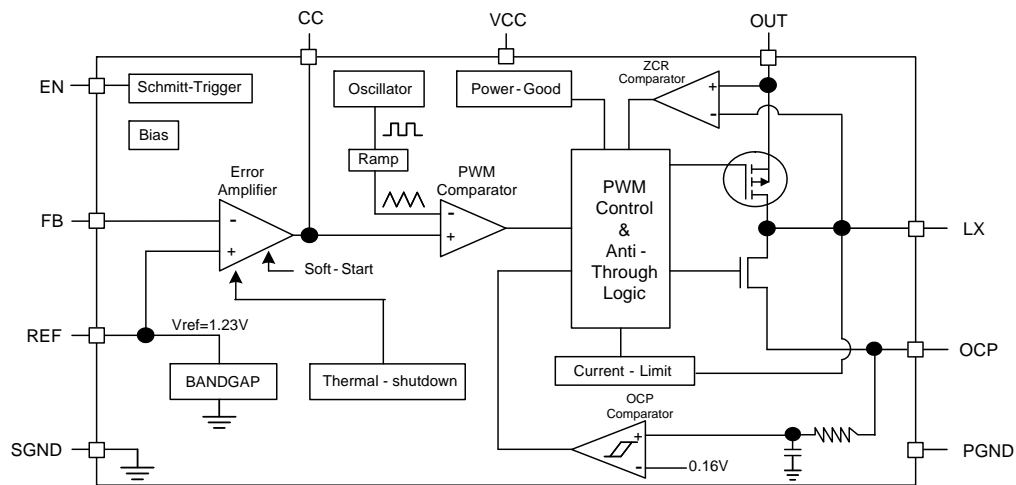

Absolute Maximum Ratings

Symbol	Parameter	Rating	Unit
ESD HBM	Human Body Model ESD Protection	3	KV
ESD MM	Machine Model ESD Protection	250	V
	OUT, V _{CC} , EN, FB, OCP to GND	-0.3 to +6.5	V
	LX to GND	-0.3 to (OUT + 0.3)	V
I _{LX}	LX Current	1.6	A
	REF, CC to GND	-0.3 to (V _{CC} + 0.3)	V
P _D	Continuous Power Dissipation (T _A = 25°C)	850	mW
T _J	Operating Junction Temperature Range	-40 to +125	°C
T _{ST}	Storage Temperature Range	-65 to +150	°C

Recommended Operating Conditions

Symbol	Parameter	Rating	Unit
T_A	Operating Ambient Temperature Range	-40 to +85	°C
V_{IN}	Supply Voltage at V_{IN} (Note 3)	0.9 to 5.5	V
V_{OUT}	Output Voltage	1.8 to 5.5	V

Notes: 3. The AP6714 is powered by step-up output. An internal low-voltage startup oscillator drives the starting at approximately 0.9V and the main control will take over as soon as output is reached. AP6714 operation could be kept in low input voltage and output current is just limited.

Electrical Characteristics ($V_{CC} = 3V$, $T_A = 25^\circ\text{C}$, unless otherwise specified)

Symbol	Parameter	Conditions	Min	Typ.	Max	Unit
GENERAL						
I_{STB}	Standby Current	$V_{CC} = 3.6V, V_{EN} = 0V$	-	0.5	1	μA
I_{CC}	Supply Current	$V_{CC} = EN = 3.6V, FB = 1.5V$	-	150	300	μA
REFERENCE						
V_{REF}	Reference Output Voltage		1.205	1.23	1.255	V
$\Delta V_{REF}/\Delta T$	Tempco of Reference	$-40^\circ\text{C} \leq T \leq 125^\circ\text{C}$		30	50	ppm/°C
$V_{REF(Load)}$	Reference Load Regulation	$10\text{mA} < I_{LOAD} < 200\text{mA}$	-	4.5	10	mV
$V_{REF(LINE)}$	Reference Line Regulation	$2.8 < V_{CC} < 5.5V$	-	1.3	5	mV
OSCILLATOR						
F_{OSC}	OSC Frequency		1400	1800	2200	KHz
STEP-UP DC-TO-DC						
$\Delta V_{OUT}/\Delta T$	Tempco of Output Voltage	$I_{OUT} = 10\text{mA}, -40^\circ\text{C} \leq T \leq 85^\circ\text{C}$		50	100	ppm/°C
	FB Input Leakage Current	$FB = 1.25V$	-100	0.01	+100	nA
Duty	Step-Up Maximum Duty Cycle	$FB = 0V$	80	85	90	%
I_{OUT}	OUT Leakage Current	$V_{LX} = 0V, OUT = 5V$	-	1	5	μA
I_{LXL}	LX Leakage Current	$V_{LX} = OUT = 5V$	-	2	5	μA
$R_{DS(ON)}$	Switch On-Resistance	N channel, $V_{CC} = 5V$	-	200	-	m Ω
		P channel, $V_{CC} = 5V$	-	300	-	
I_{LM}	N-Channel Current Limit	$V_{IN} = 1.5V$ (Note 4)	1.2	1.4	1.6	A
THERMAL SHUTDOWN PROTECTION						
	Thermal Shutdown		-	150	-	°C
	Thermal Hysteresis		-	40	-	°C
LOGIC INPUTS						
	EN Input Low Level	$1.5V < V_{CC} < 5.5V$	-	-	0.4	V
	EN Input High Level	$1.5V < V_{CC} < 5.5V$	0.8	-	-	V
OVER CURRENT PROTECTION						
V_{OCP}	Over Current Protection Voltage	$R_{OCP} = 0.1\Omega$	-	0.16	-	V
THERMAL RESISTANCE						
θ_{JA}	Thermal Resistance Junction-to-Ambient	MSOP-10L (Note 5)		161		°C/W
θ_{JC}	Thermal Resistance Junction-to-Case	MSOP-10L (Note 5)		43		°C/W

Notes: 4. The step-up current limit in startup refers to the LX switch current limit, not the output current limit.

5. Test condition for MSOP-10L: Device mounted on 2oz copper, minimum recommended pad layout on top & bottom layer with thermal vias, double sided FR-4 PCB.

Typical Operating Characteristics

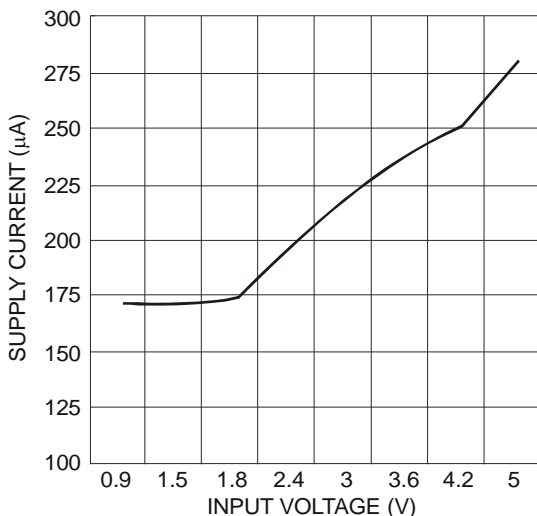

Fig. 1 Supply Current vs. Input Voltage

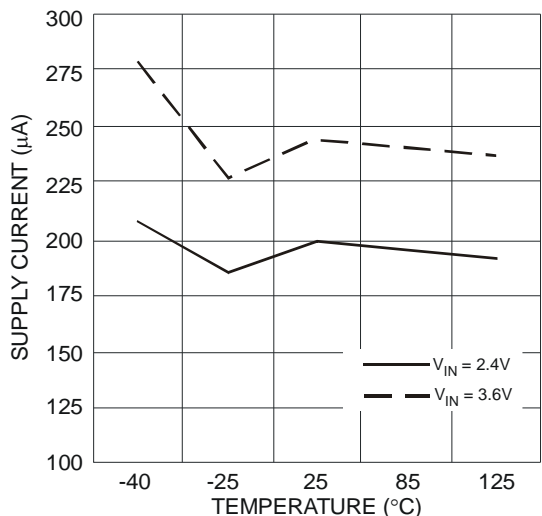

Fig. 2 Supply Current vs. Temperature

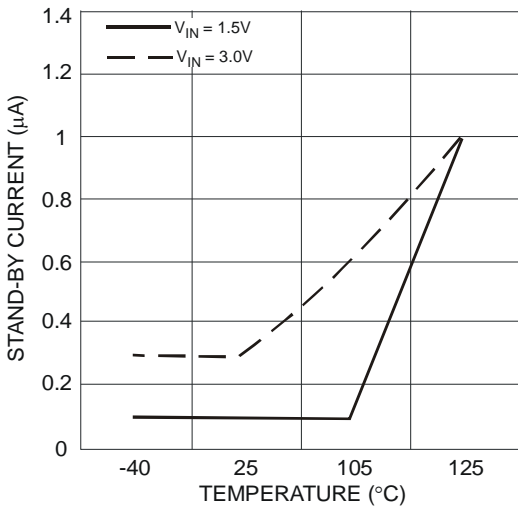

Fig. 3 Stand-by Current vs. Temperature

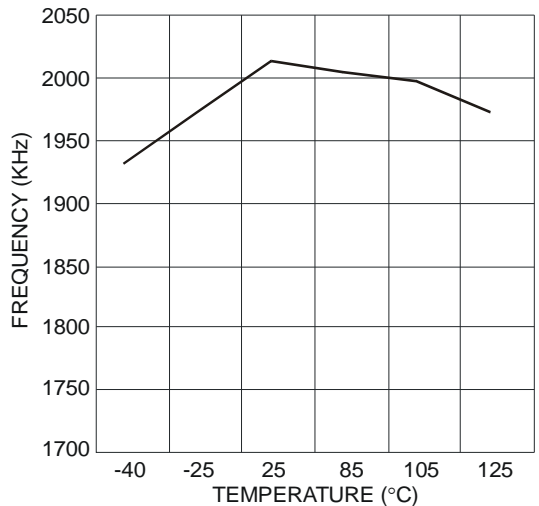

Fig. 4 Frequency vs. Temperature

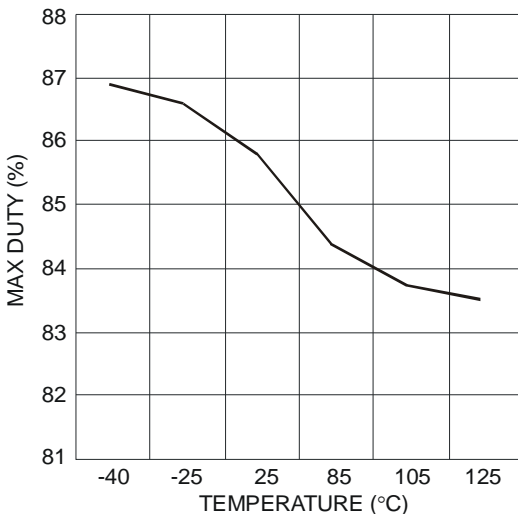

Fig. 5 Max Duty vs. Temperature

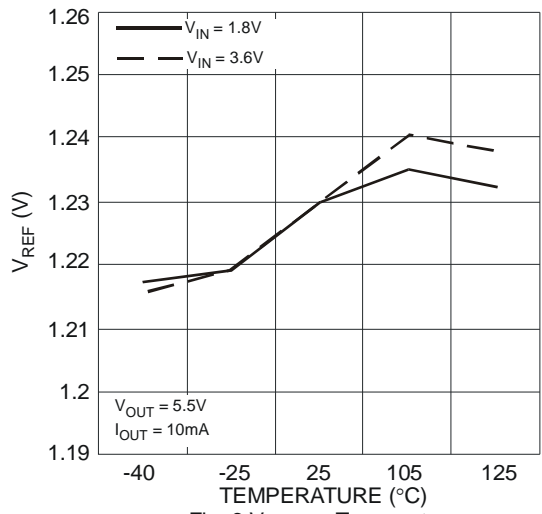

Fig. 6 V_{REF} vs. Temperature

Typical Operating Characteristics (cont.)

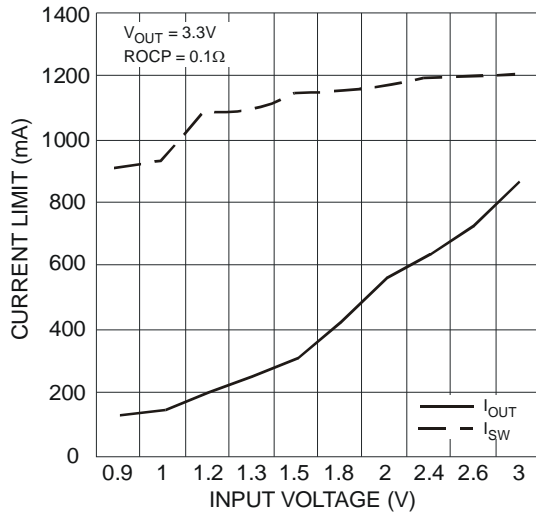

Fig. 7 Input Voltage vs. Current Limit

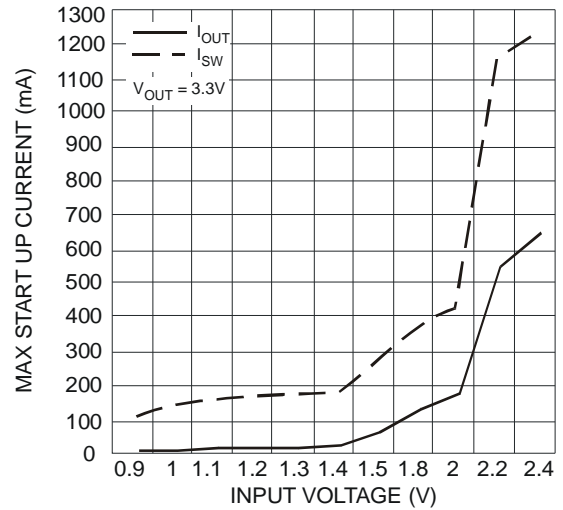

Fig. 8 Input Voltage vs. Max Start Up Current

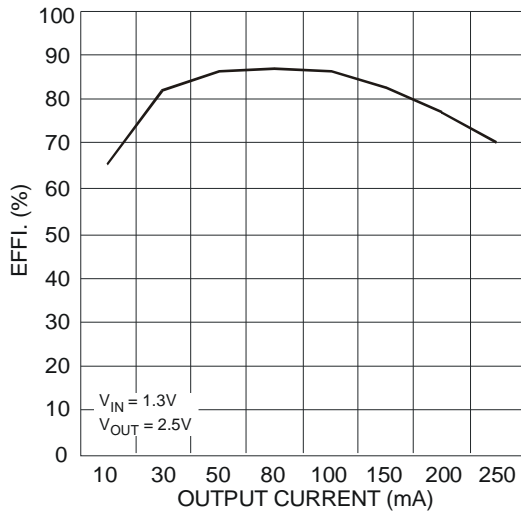

Fig. 9 EFFI. vs. Output Current

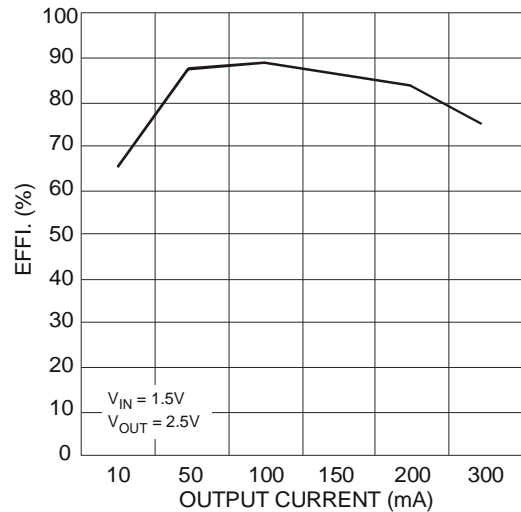

Fig. 10 EFFI. vs. Output Current

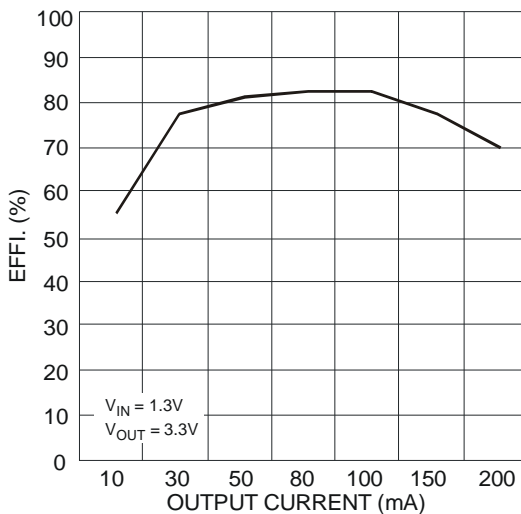

Fig. 11 EFFI. vs. Output Current

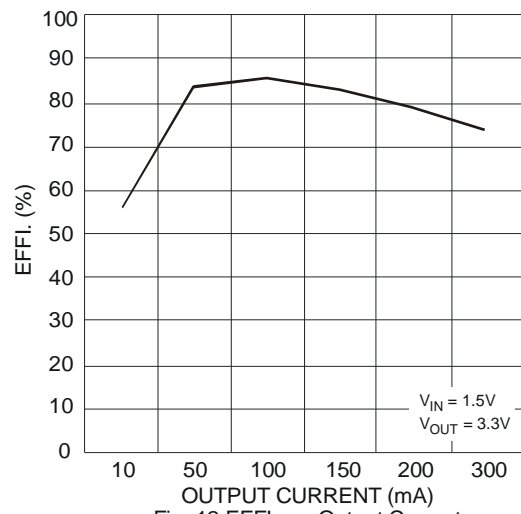

Fig. 12 EFFI. vs. Output Current

Typical Operating Characteristics (cont.)

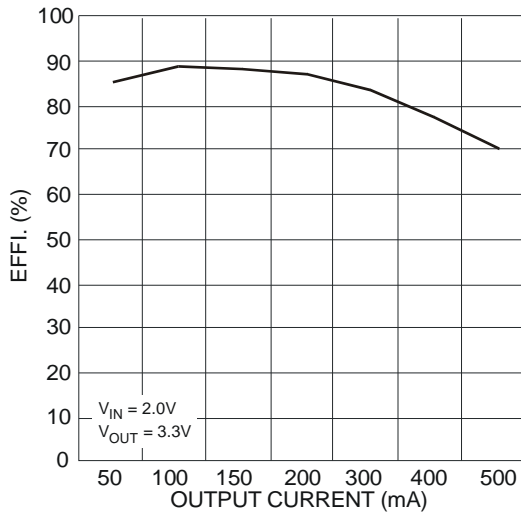

Fig. 13 EFFI. vs. Output Current

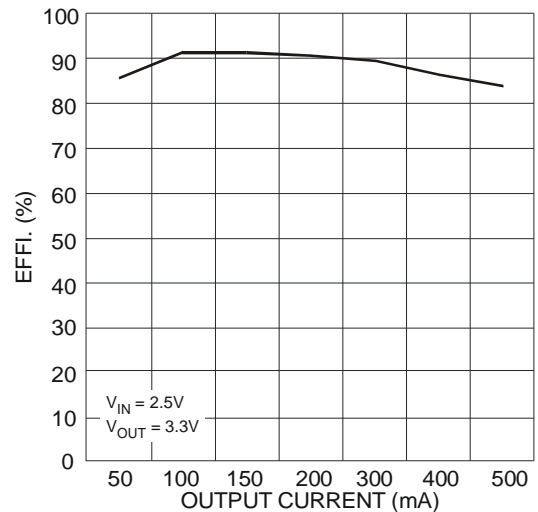

Fig. 14 EFFI. vs. Output Current

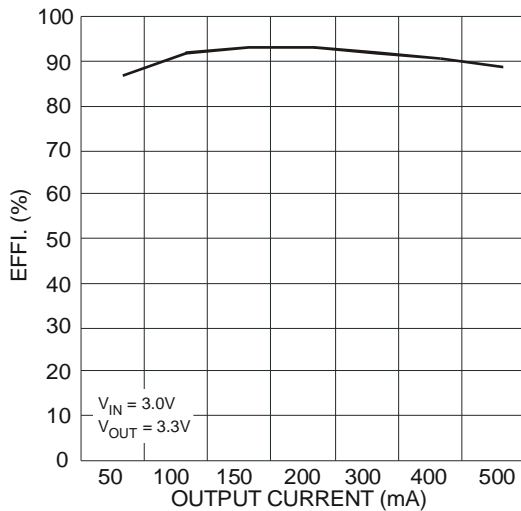

Fig. 15 EFFI. vs. Output Current

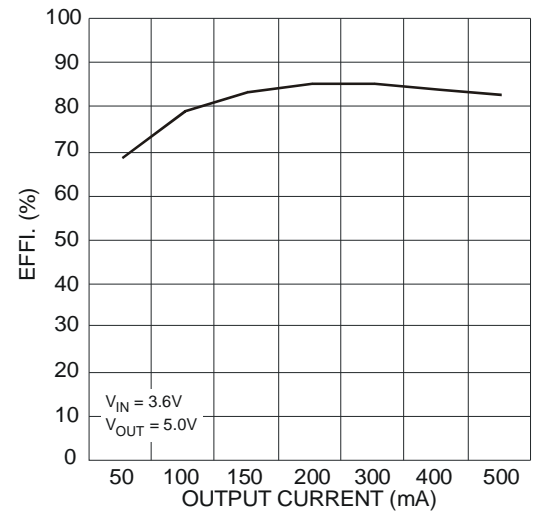

Fig. 16 EFFI. vs. Output Current

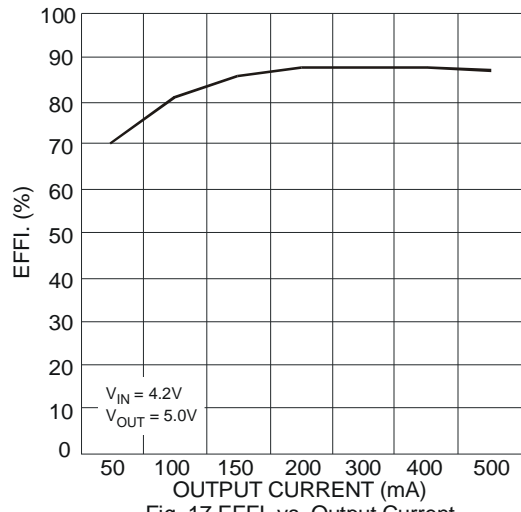

Fig. 17 EFFI. vs. Output Current

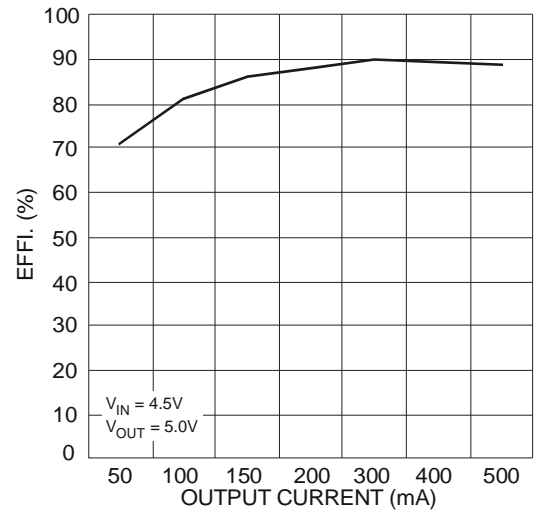

Fig. 18 EFFI. vs. Output Current

Typical Operating Characteristics (cont.)

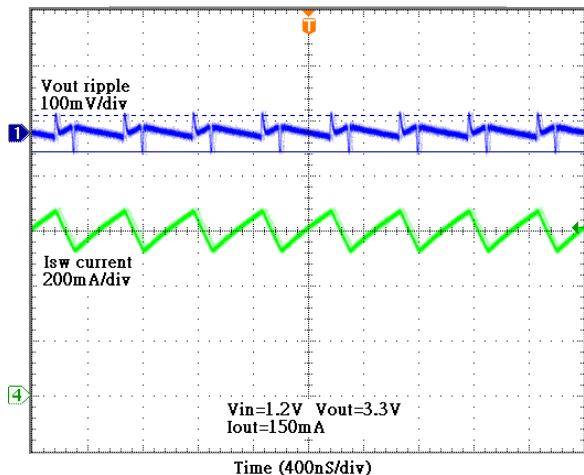

Fig. 19 Switching Current vs. Output Ripple

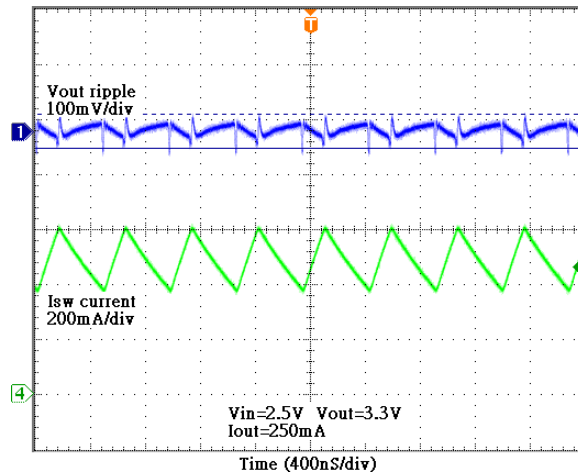

Fig. 20 Switching Current vs. Output Ripple

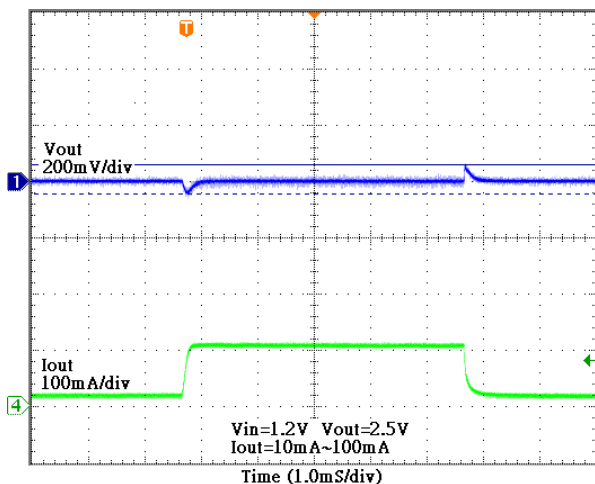

Fig. 21 Load Transient Response

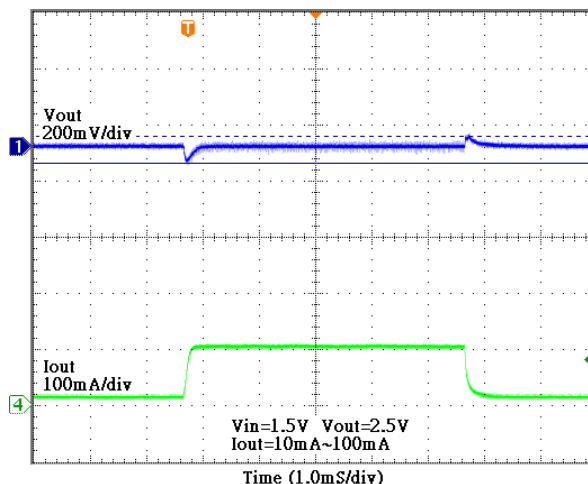

Fig. 22 Load Transient Response

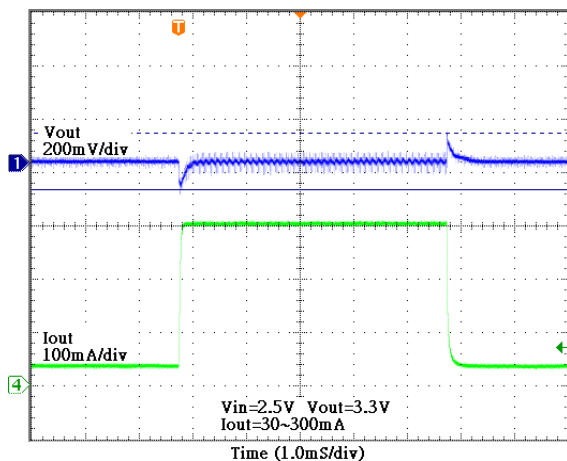

Fig. 23 Load Transient Response

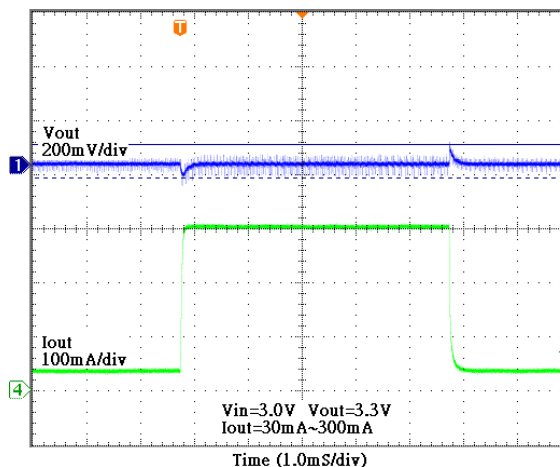

Fig. 24 Load Transient Response

Typical Operating Characteristics (cont.)

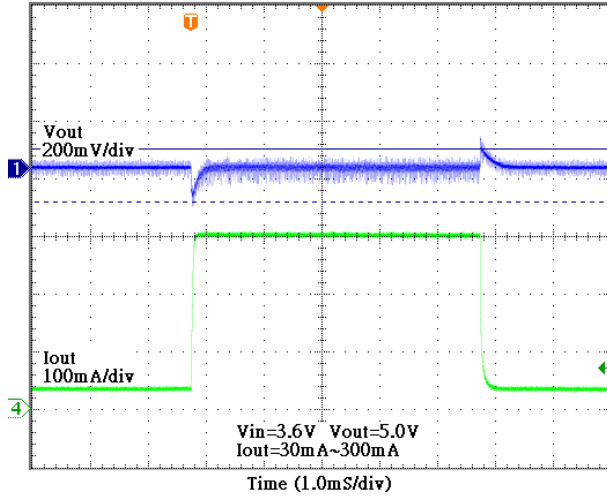

Fig. 25 Load Transient Response

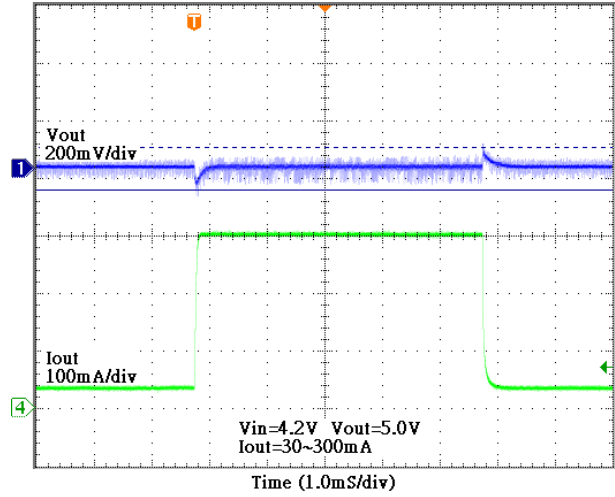

Fig. 26 Load Transient Response

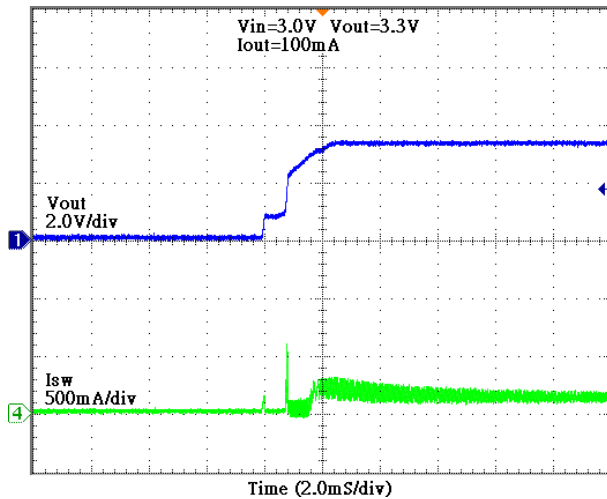

Fig. 27 Power On Wave

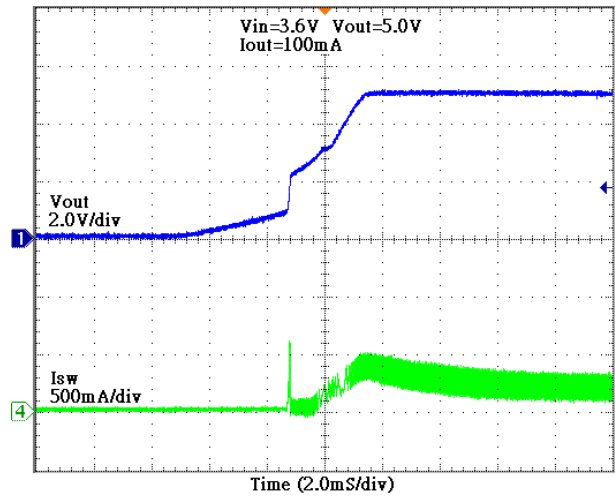

Fig. 28 Power On Wave

Application Information

Input Capacitor Selection

The input filter capacitor reduces peak currents drawn from the input source and reduces input switching noise. In most applications a 10µF is recommended.

Output Capacitor Selection

The major parameter necessary to define the output capacitor is the maximum allowed output voltage ripple of the converter. This ripple is determined by two parameters of the capacitor, the capacitance and the ESR (Equivalent Series Resistance). It is possible to calculate the minimum capacitance needed for the defined ripple, supposing that ESR is zero, by using Equation below:

$$C_{MIN} = \frac{I_{OUT} \times (V_{OUT} - V_{IN})}{f \times \Delta V \times V_{OUT}}$$

where

f = the switching frequency

ΔV = the maximum allowed ripple

Shutdown Mode

The AP6714 converter will stop switching by setting EN pin Low, and is turned on by pulling it high. If this feature is not used, the EN pin should be tied to VCC pin to keep the regulator output on all the time. To ensure proper operation, the signal source used to drive the EN pin must be able to swing above and below the specified turn-on/off voltage thresholds listed in the Electrical Characteristics section under V_{IL} and V_{IH} .

Inductor Selection

The high frequency operation of the AP6714 allows the use of small surface mount inductors. The minimum inductance value is limited by the following constraints:

$$L > \frac{V_{IN(MIN)} \times (V_{OUT(MAX)} - V_{IN(MIN)})}{f \times I_{SW(Ripple)} \times V_{OUT(MAX)}} H$$

Where

f = Operating frequency (Hz)

$I_{SW(Ripple)}$ = Allowable Inductor Current Ripple (A)

$V_{IN(MIN)}$ = Minimum Input Voltage (V)

$V_{OUT(MAX)}$ = Maximum Output Voltage (V)

Over Current Protection (OCP)

A resistor is required to connect PGND pin and OCP pin to prevent an overload occurs at the output. The output voltage will drop and duty cycle will be reduced if the

OCP exceeds 0.16V. When R_{OCP} is 0.1Ω, the maximum switching current to operate normally is 1.6A (0.16V/0.1Ω). However, the actual switching current is related to duty ratio. By the way, larger R_{OCP} is recommended when $V_{OUT} - V_{IN} \leq 0.5V$ since the dropped output voltage is smaller than regular case while an overload condition exists.

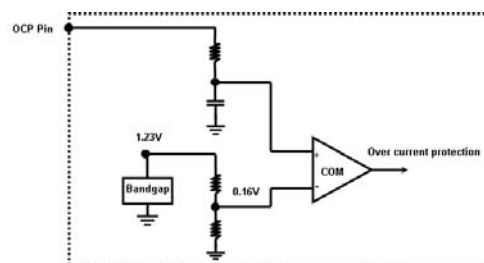

Internal circuit of OCP function

Thermal Information

The maximum recommended junction temperature (T_J) of AP6714 is 125°C. The thermal resistance of the 10-pin MSOP10 package is $R_{\theta JA} = 161^\circ C/W$, if the Power PAD is soldered. Specified regulator operation is assured to an ambient temperature T_A of 45°C. Therefore, the maximum power dissipation is about 500mW. More power can be dissipated if the maximum ambient temperature of the application is lower.

$$P_{D(MAX)} = \frac{T_{J(MAX)} - T_A}{R_{\theta JA}}$$

Designing a PC Board

Good PC board layout is important to achieve optimal performance from AP6714. Poor design can cause excessive conducted and/or radiated noise. Conductors carrying discontinuous currents and any high-current path should be made as short and wide as possible. A separate low-noise ground plane containing the reference and signal grounds should connect to the power-ground plane at only one point to minimize the effects of power-ground currents. Typically, the ground planes are best joined right at the IC. Keep the voltage-feedback network very close to the IC, preferably within 0.2in (5mm) of the FB pin. Nodes with high dV/dt (switching nodes) should be kept as small as possible and should be routed away from high-impedance nodes such as FB.

Ordering Information

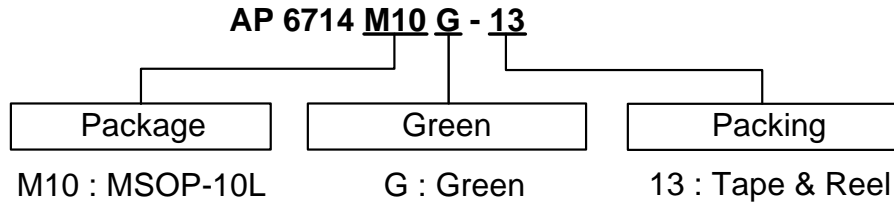

Device	Package Code	Packaging (Note 6)	13" Tape and Reel	
			Quantity	Part Number Suffix
AP6714M10G-13	M10	MSOP-10L	2500/Tape & Reel	-13

Notes: 6. Pad layout as shown on Diodes Inc. suggested pad layout document AP02001, which can be found on our website at <http://www.diodes.com/datasheets/ap02001.pdf>.

Marking Information

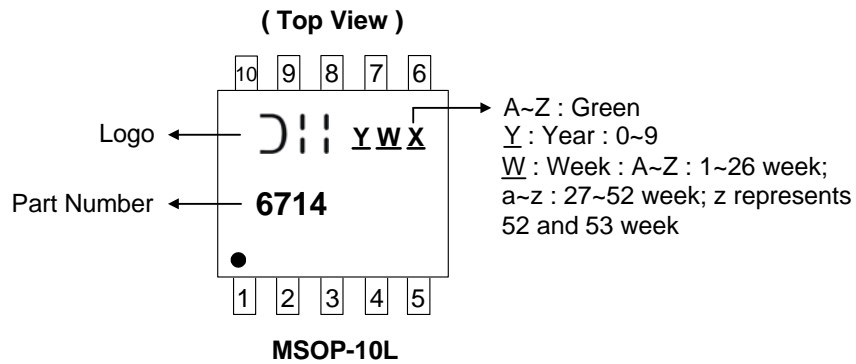

Package Outline Dimensions (All Dimensions in mm)

MSOP-10L

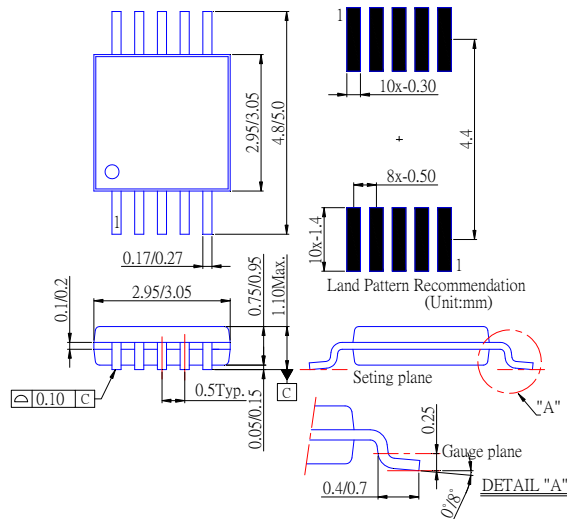

IMPORTANT NOTICE

DIODES INCORPORATED MAKES NO WARRANTY OF ANY KIND, EXPRESS OR IMPLIED, WITH REGARDS TO THIS DOCUMENT, INCLUDING, BUT NOT LIMITED TO, THE IMPLIED WARRANTIES OF MERCHANTABILITY AND FITNESS FOR A PARTICULAR PURPOSE (AND THEIR EQUIVALENTS UNDER THE LAWS OF ANY JURISDICTION).

Diodes Incorporated and its subsidiaries reserve the right to make modifications, enhancements, improvements, corrections or other changes without further notice to this document and any product described herein. Diodes Incorporated does not assume any liability arising out of the application or use of this document or any product described herein; neither does Diodes Incorporated convey any license under its patent or trademark rights, nor the rights of others. Any Customer or user of this document or products described herein in such applications shall assume all risks of such use and will agree to hold Diodes Incorporated and all the companies whose products are represented on Diodes Incorporated website, harmless against all damages.

Diodes Incorporated does not warrant or accept any liability whatsoever in respect of any products purchased through unauthorized sales channel.

Should Customers purchase or use Diodes Incorporated products for any unintended or unauthorized application, Customers shall indemnify and hold Diodes Incorporated and its representatives harmless against all claims, damages, expenses, and attorney fees arising out of, directly or indirectly, any claim of personal injury or death associated with such unintended or unauthorized application.

Products described herein may be covered by one or more United States, international or foreign patents pending. Product names and markings noted herein may also be covered by one or more United States, international or foreign trademarks.

LIFE SUPPORT

Diodes Incorporated products are specifically not authorized for use as critical components in life support devices or systems without the express written approval of the Chief Executive Officer of Diodes Incorporated. As used herein:

A. Life support devices or systems are devices or systems which:

1. are intended to implant into the body, or
2. support or sustain life and whose failure to perform when properly used in accordance with instructions for use provided in the labeling can be reasonably expected to result in significant injury to the user.

B. A critical component is any component in a life support device or system whose failure to perform can be reasonably expected to cause the failure of the life support device or to affect its safety or effectiveness.

Customers represent that they have all necessary expertise in the safety and regulatory ramifications of their life support devices or systems, and acknowledge and agree that they are solely responsible for all legal, regulatory and safety-related requirements concerning their products and any use of Diodes Incorporated products in such safety-critical, life support devices or systems, notwithstanding any devices- or systems-related information or support that may be provided by Diodes Incorporated. Further, Customers must fully indemnify Diodes Incorporated and its representatives against any damages arising out of the use of Diodes Incorporated products in such safety-critical, life support devices or systems.

Copyright © 2011, Diodes Incorporated

www.diodes.com