

HiPerFET™ Power MOSFETs Q-Class

IXFB 72N55Q2

$V_{DSS} = 550 \text{ V}$
 $I_{D25} = 72 \text{ A}$
 $R_{DS(on)} = 72 \text{ m}\Omega$
 $t_{rr} \leq 250 \text{ ns}$

N-Channel Enhancement Mode
 Avalanche Rated, Low Q_g , Low Intrinsic R_g
 High dV/dt , Low t_{rr}

Preliminary Data Sheet

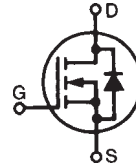

PLUS 264™ (IXFB)

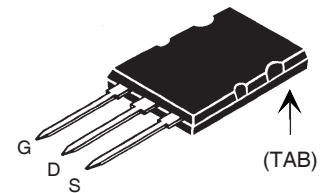

G = Gate D = Drain
 S = Source TAB = Drain

Symbol	Test Conditions	Maximum Ratings	
V_{DSS}	$T_J = 25^\circ\text{C}$ to 150°C	550	V
V_{DGR}	$T_J = 25^\circ\text{C}$ to 150°C ; $R_{GS} = 1 \text{ M}\Omega$	550	V
V_{GS}	Continuous	± 30	V
V_{GSM}	Transient	± 40	V
I_{D25}	$T_C = 25^\circ\text{C}$	72	A
I_{DM}	$T_C = 25^\circ\text{C}$, pulse width limited by T_{JM}	284	A
I_{AR}	$T_C = 25^\circ\text{C}$	72	A
E_{AR}	$T_C = 25^\circ\text{C}$	60	mJ
E_{AS}	$T_C = 25^\circ\text{C}$	5.0	J
dv/dt	$I_S \leq I_{DM}$, $di/dt \leq 100 \text{ A}/\mu\text{s}$, $V_{DD} \leq V_{DSS}$ $T_J \leq 150^\circ\text{C}$, $R_G = 2 \Omega$	20	V/ns
P_D	$T_C = 25^\circ\text{C}$	890	W
T_J		-55 ... +150	$^\circ\text{C}$
T_{JM}		150	$^\circ\text{C}$
T_{stg}		-55 ... +150	$^\circ\text{C}$
T_L	1.6 mm (0.063 in.) from case for 10 s	300	$^\circ\text{C}$
F_c	Mounting Force	30...120/7.5...27 N/lb	
Weight		10	g

Features

- Double metal process for low gate resistance
- Unclamped Inductive Switching (UIS) rated
- Low package inductance
- easy to drive and to protect
- Fast intrinsic rectifier

Applications

- DC-DC converters
- Switched-mode and resonant-mode power supplies, >500kHz switching
- DC choppers
- Pulse generation
- Laser drivers

Advantages

- PLUS 264™ package for clip or spring mounting
- Space savings
- High power density

Symbol	Test Conditions	Characteristic Values ($T_J = 25^\circ\text{C}$, unless otherwise specified)		
		min.	typ.	max.
V_{DSS}	$V_{GS} = 0 \text{ V}$, $I_D = 1 \text{ mA}$	550		V
$V_{GS(th)}$	$V_{DS} = V_{GS}$, $I_D = 8 \text{ mA}$	2.5		5.0 V
I_{GSS}	$V_{GS} = \pm 30 \text{ V}$, $V_{DS} = 0$			$\pm 200 \text{ nA}$
I_{DSS}	$V_{DS} = V_{DSS}$ $V_{GS} = 0 \text{ V}$		$T_J = 25^\circ\text{C}$ $T_J = 125^\circ\text{C}$	100 μA 5 mA
$R_{DS(on)}$	$V_{GS} = 10 \text{ V}$, $I_D = 0.5 \cdot I_{D25}$ Note 1			72 m Ω

Symbol	Test Conditions	Characteristic Values ($T_J = 25^\circ\text{C}$, unless otherwise specified)		
		min.	typ.	max.
g_{fs}	$V_{DS} = 10\text{ V}; I_D = 0.5 \cdot I_{D25}$ Note 1	40	57	S
C_{iss}	$V_{GS} = 0\text{ V}, V_{DS} = 25\text{ V}, f = 1\text{ MHz}$		10500	pF
C_{oss}			1500	pF
C_{rss}			230	pF
$t_{d(on)}$	$V_{GS} = 10\text{ V}, V_{DS} = 0.5 \cdot V_{DSS}, I_D = 0.5 \cdot I_{D25}$ $R_G = 1\ \Omega$ (External)		30	ns
t_r			23	ns
$t_{d(off)}$			58	ns
t_f			10	ns
$Q_{g(on)}$	$V_{GS} = 10\text{ V}, V_{DS} = 0.5 \cdot V_{DSS}, I_D = 0.5 \cdot I_{D25}$		258	nC
Q_{gs}			65	nC
Q_{gd}			123	nC
R_{thJC}			0.14	K/W
R_{thCK}			0.13	K/W

Source-Drain Diode

Symbol	Test Conditions	Characteristic Values ($T_J = 25^\circ\text{C}$, unless otherwise specified)		
		min.	typ.	max.
I_S	$V_{GS} = 0\text{ V}$			72 A
I_{SM}	Repetitive; pulse width limited by T_{JM}			288 A
V_{SD}	$I_F = I_S, V_{GS} = 0\text{ V}$, Note 1			1.5 V
t_{rr}	$I_F = 25\text{ A}$ $-di/dt = 100\text{ A}/\mu\text{s}$ $V_R = 100\text{ V}$			250 ns
Q_{RM}			1.2	μC
I_{RM}			8	A

Note: 1. Pulse test, $t \leq 300\ \mu\text{s}$, duty cycle $d \leq 2\%$

PLUS 264™ Outline

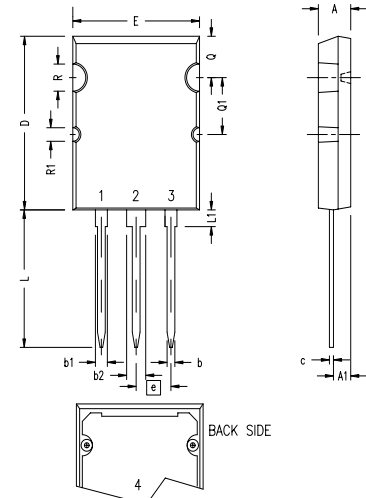

Terminals: 1 - Gate
2 - Drain (Collector)
3 - Source (Emitter)
4 - Drain (Collector)

SYM	INCHES	
	MIN	MAX
A	.185	.209
A1	.102	.118
b	.037	.055
b1	.087	.102
b2	.110	.126
c	.017	.029
D	1.007	1.047
E	.760	.799
e	.215 BSC	
L	.779	.842
L1	.087	.102
Q	.240	.256
Q1	.330	.346
$\varnothing R$.155	.187
$\varnothing R1$.085	.093

IXYS reserves the right to change limits, test conditions, and dimensions.

IXYS MOSFETs and IGBTs are covered by one or more of the following U.S. patents:

4,835,592 4,881,106 5,017,508 5,049,961 5,187,117 5,486,715 6,306,728B1 6,259,123B1 6,306,728B1
4,850,072 4,931,844 5,034,796 5,063,307 5,237,481 5,381,025 6,404,065B1 6,162,665 6,534,343

**Fig. 1. Output Characteristics
@ 25 Deg. C**

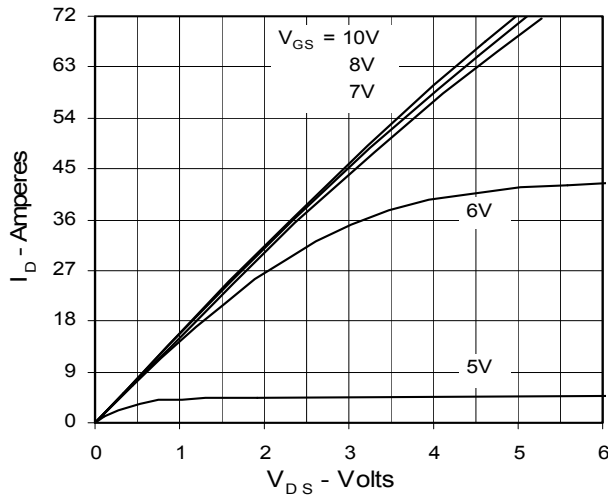

**Fig. 2. Extended Output Characteristics
@ 25 deg. C**

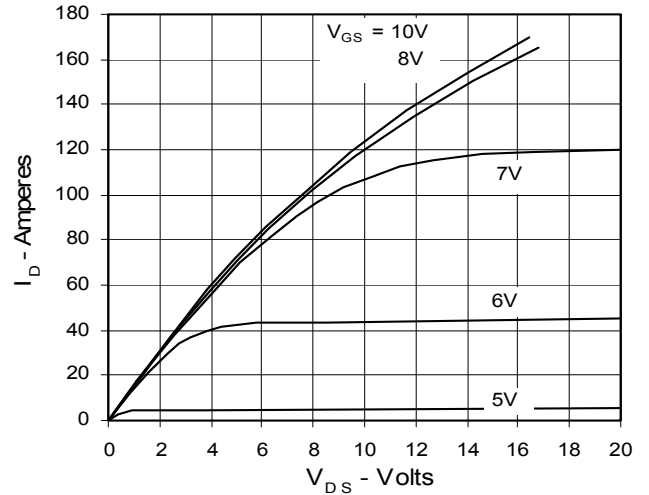

**Fig. 3. Output Characteristics
@ 125 Deg. C**

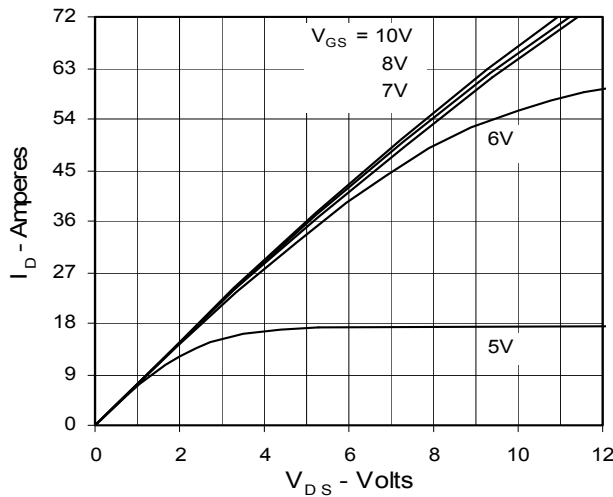

**Fig. 4. $R_{DS(on)}$ Normalized to I_{D25} Value vs.
Junction Temperature**

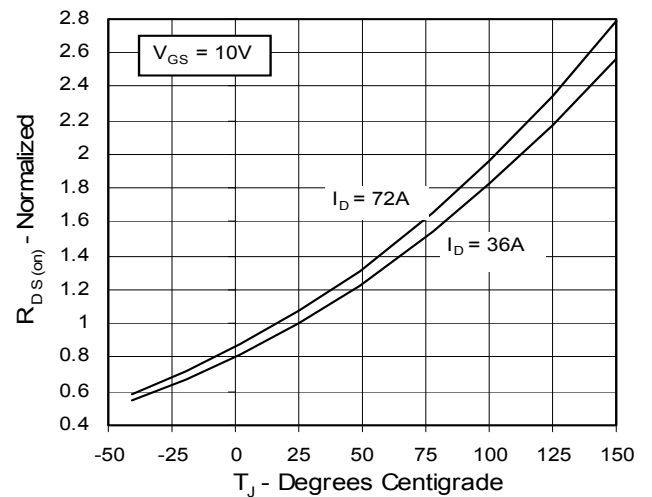

**Fig. 5. $R_{DS(on)}$ Normalized to I_{D25}
Value vs. I_D**

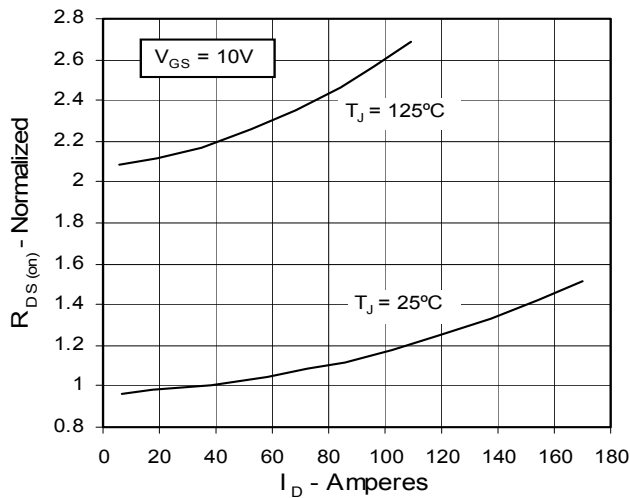

**Fig. 6. Drain Current vs. Case
Temperature**

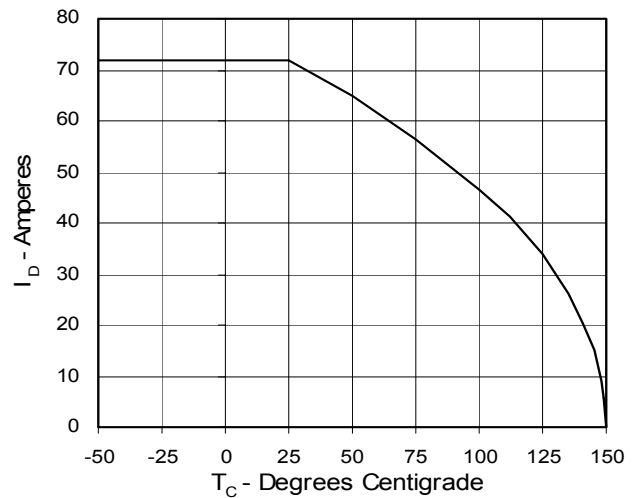

Fig. 7. Input Admittance

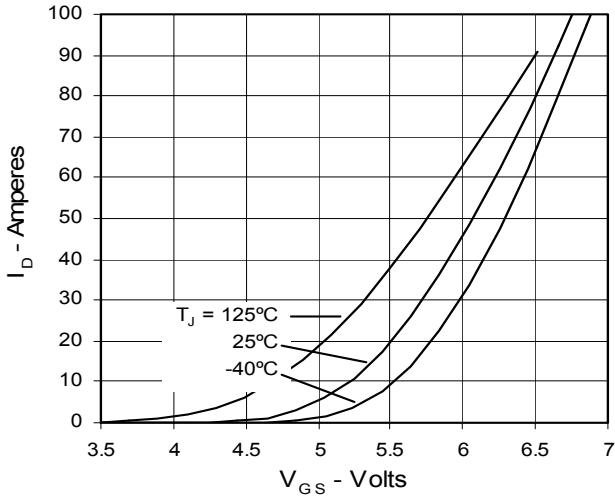

Fig. 8. Transconductance

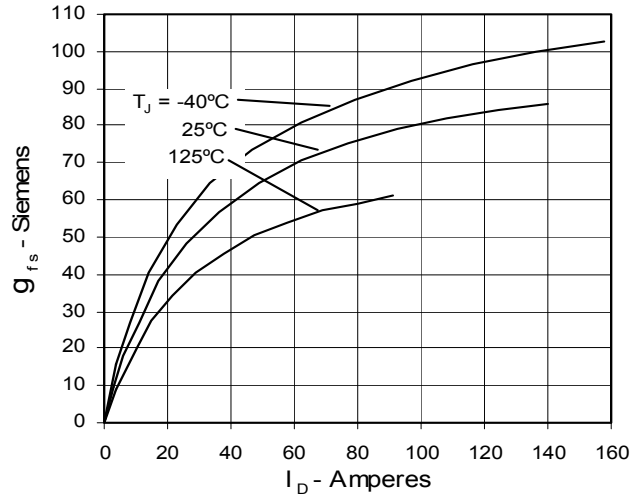

Fig. 9. Source Current vs. Source-To-Drain Voltage

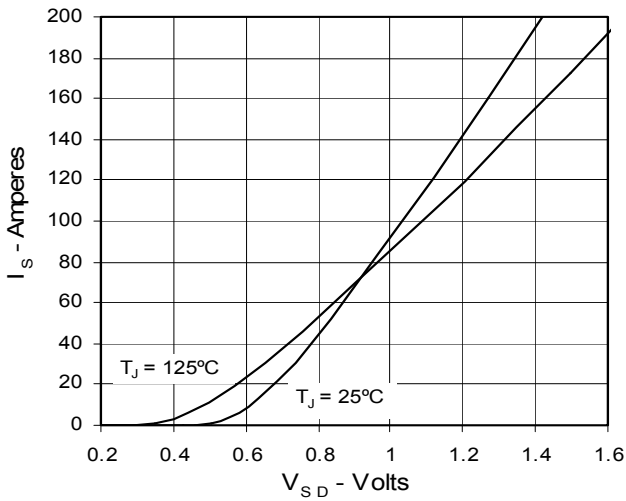

Fig. 10. Gate Charge

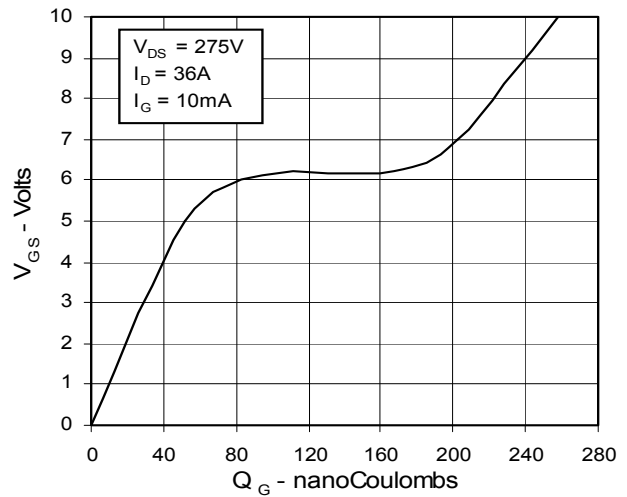

Fig. 11. Capacitance

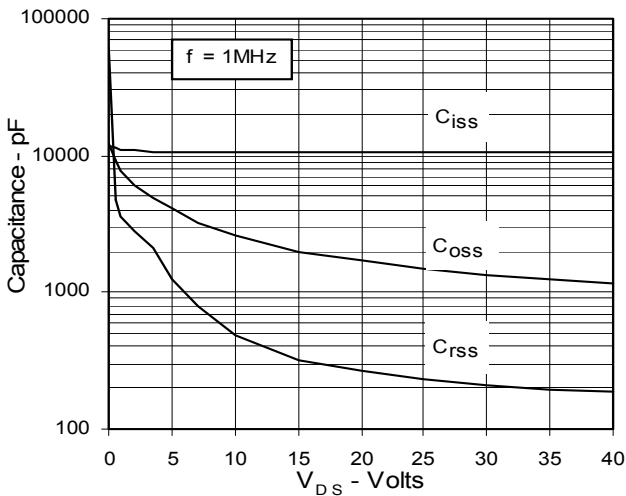
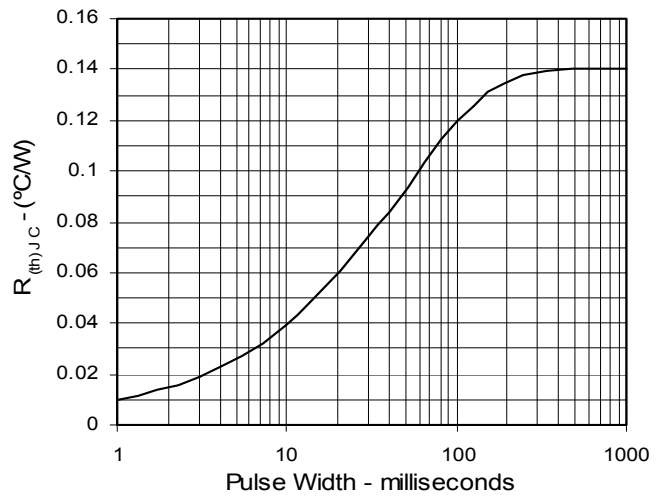

Fig. 12. Maximum Transient Thermal Resistance



IXYS reserves the right to change limits, test conditions, and dimensions.

IXYS MOSFETs and IGBTs are covered by one or more of the following U.S. patents:

4,835,592 4,881,106 5,017,508 5,049,961 5,187,117 5,486,715 6,306,728B1 6,259,123B1 6,306,728B1
4,850,072 4,931,844 5,034,796 5,063,307 5,237,481 5,381,025 6,404,065B1 6,162,665 6,534,343