

**DESIGNED & DIMENSIONED
IN MILLIMETERS [ENGLISH]**

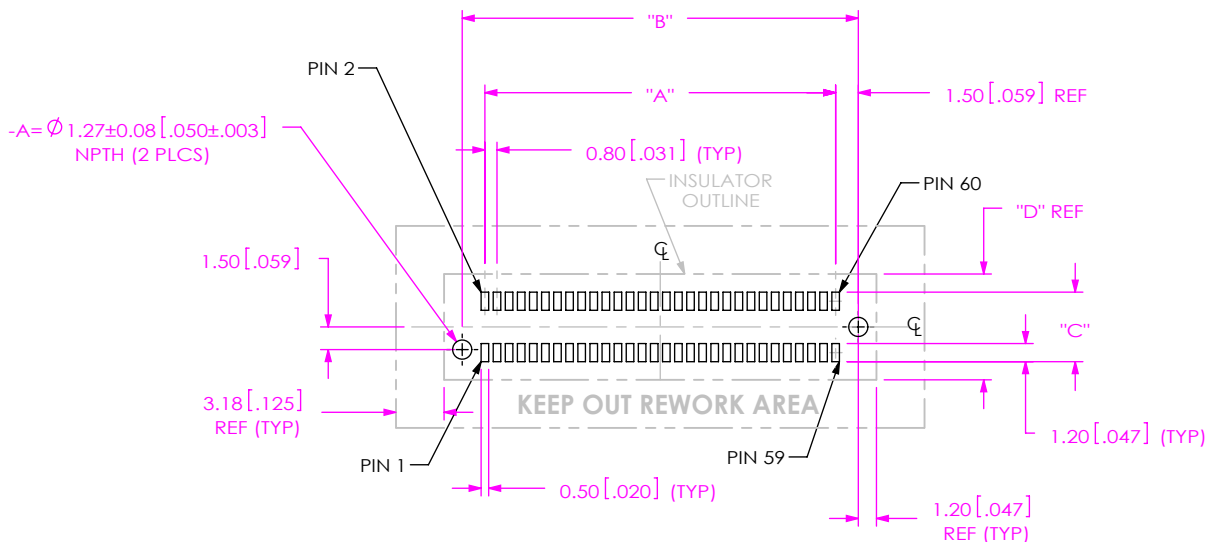

FIG 1
-30 POSITION SHOWN
USE FOR -10, *-13, -20, & -30 POSITIONS WITH -A OPTION

POSITION	"A"	"B"
-10	7.20[.283]	10.20[.402]
*-13	9.60[.378]	N/A
-20	15.20[.598]	18.20[.717]
-30	23.20[.913]	26.20[1.031]

*-13 POSITION IS ONLY AVAILABLE IN THIS FOOTPRINT WITH THE -PE OPTION

MATING CARD THICKNESS TYPE	"C"	"D"
-01	4.60[.181]	7.00[.276]
-02	5.03[.198]	7.43[.293]
-03	5.39[.212]	7.79[.307]

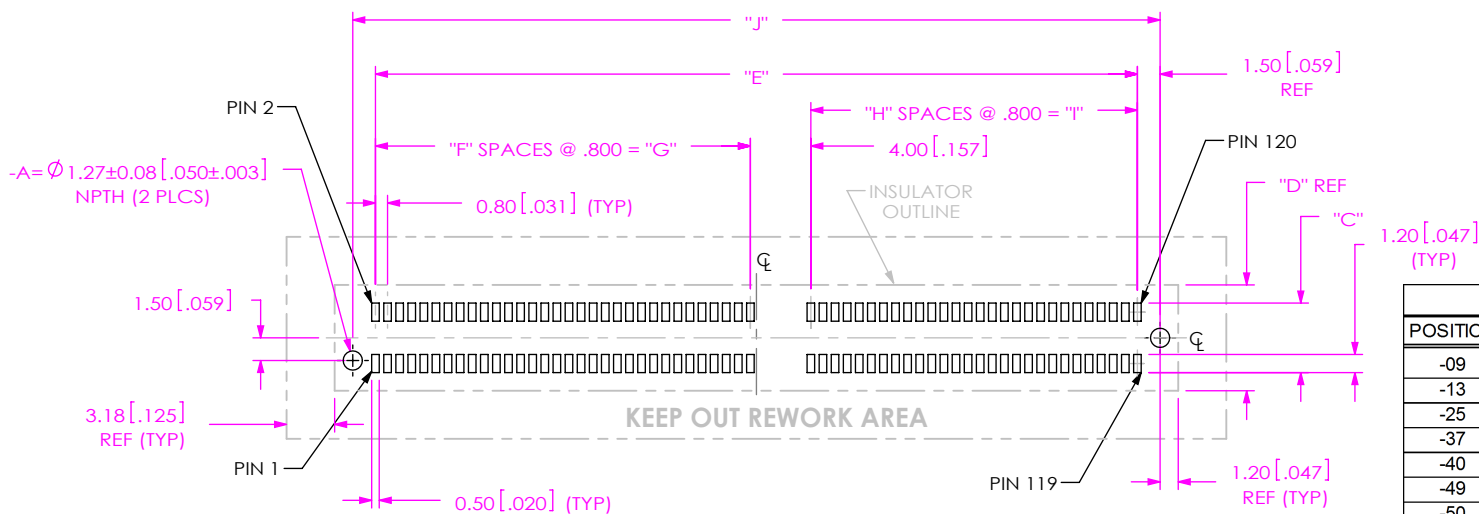

FIG 2
-60 POSITION SHOWN
USE FOR **09, -13, -25, -37, -40, -49, -50, -60, -70, -80, -90, & -100 POSITIONS WITH -A OPTION
****09 OPTION ONLY AVAILABLE IN -L2**

POSITION	"E"	"F"	"G"	"H"	"I"	"J"
-09	9.60[.378]	3	2.40[.094]	4	3.20[.126]	N/A
-13	12.80[.504]	5	4.00[.157]	6	4.80[.189]	15.80[.622]
-25	22.40[.882]	5	4.00[.157]	18	14.40[.567]	25.40[1.000]
-37	32.00[1.260]	20	16.00[.630]	15	12.00[.472]	35.00[1.378]
-40	34.40[1.354]	21	16.80[.661]	17	13.60[.535]	37.40[1.472]
-49	41.60[1.354]	26	20.80[.819]	21	16.80[.661]	44.60[1.756]
-50	42.40[1.669]	26	20.80[.819]	22	17.60[.693]	45.40[1.787]
-60	50.40[1.984]	31	24.80[.976]	27	21.60[.850]	53.40[2.102]
-70	58.40[2.299]	31	24.80[.976]	37	29.60[1.165]	61.40[2.417]
-80	66.40[2.614]	31	24.80[.976]	47	37.60[1.480]	69.40[2.732]
-90	74.40[2.929]	31	24.80[.976]	57	45.60[1.795]	77.40[3.047]
-100	82.40[3.244]	31	24.80[.976]	67	53.60[2.110]	85.40[3.362]

- NOTES
 1. POSITIONS -09, -13, -25, -37 & -49 ONLY AVAILABLE WITH -01 CARD THICKNESS.
 2. POSITIONS -70, -80, -90 & -100 ONLY AVAILABLE WITH -01 & -03 CARD THICKNESS.

TOLERANCES ARE:
 DECIMALS
 X: ± .3[.01]
 XX: ± .10[.004]
 XXX: ± .05[.0020]

ANGLES
 2°

PROPRIETARY NOTICE
 THIS DOCUMENT CONTAINS CONFIDENTIAL AND PROPRIETARY INFORMATION AND ALL DESIGN, MANUFACTURING, REPRODUCTION, USE, PATENT RIGHTS AND SALES RIGHTS ARE EXPRESSLY RESERVED BY SAMTEC, INC. THIS DOCUMENT SHALL NOT BE DISCLOSED, IN WHOLE OR PART, TO ANY UNAUTHORIZED PERSON OR ENTITY NOR REPRODUCED, TRANSFERRED OR INCORPORATED IN ANY OTHER PRODUCT IN ANY MANNER WITHOUT THE EXPRESS WRITTEN CONSENT OF SAMTEC, INC.



520 PARK EAST BLVD, NEW ALBANY, IN 47150
 PHONE: 812-944-6733 FAX: 812-948-5047
 e-Mail: info@SAMTEC.com code: 55322

-WT & -BL = $\varnothing 0.84 \pm 0.08$ [.033 ± .003]
 PTH (2 PLCS)
 (TO BE SOLDERED USING
 PASTE-IN-HOLE TECHNOLOGY)

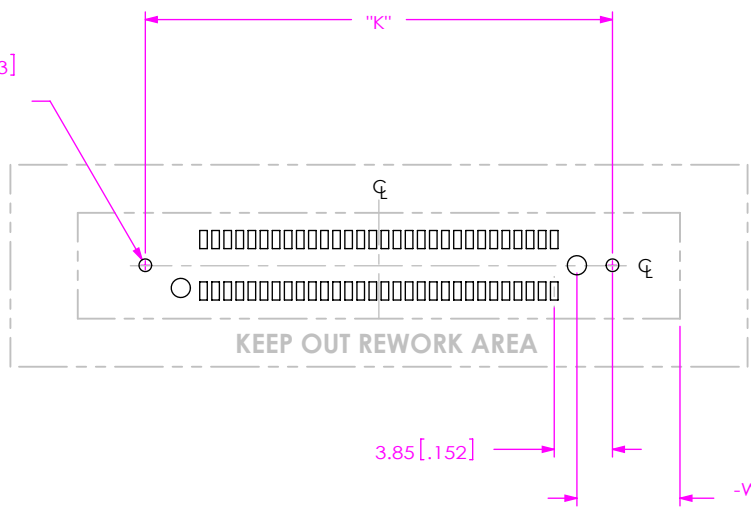

POSITION	"K"
-10	14.90 [.587]
-20	22.90 [.902]
-30	30.90 [1.220]

FIG 3
 -30 POSITION SHOWN
 (SAME AS FIG 1, EXCEPT AS SHOWN)
USE FOR -10, -20 OR -30 POSITIONS WITH -WT & -BL OPTION
-BL TYPE ONLY AVAILABLE WITH -01 CARD
-WT TYPE ONLY AVAILABLE WITH -01 & -03 CARD

-WT & -BL = $\varnothing 0.84 \pm 0.08$ [.033 ± .003]
 PTH (2 PLCS)
 (TO BE SOLDERED USING
 PASTE-IN-HOLE TECHNOLOGY)

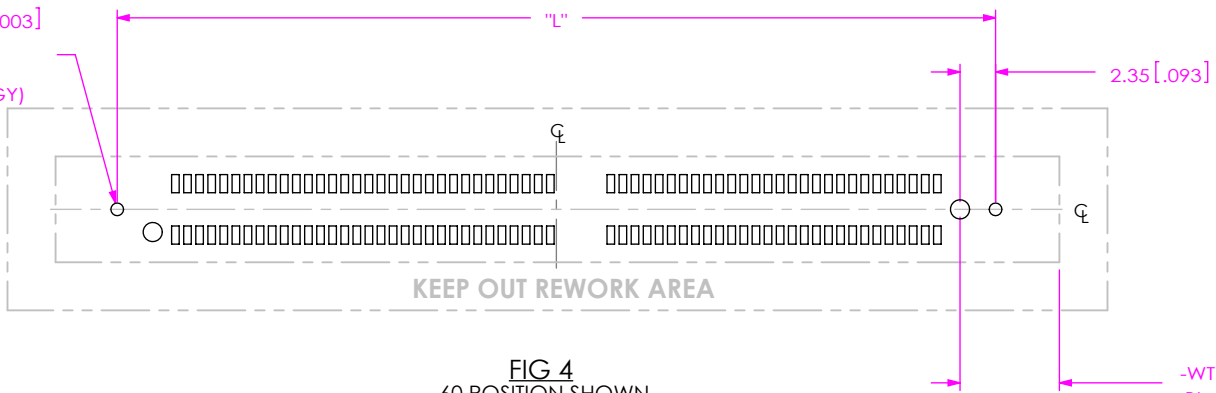

POSITION	"L"
-09	17.30 [0.681]
-13	20.50 [0.807]
-25	30.10 [1.185]
-37	39.70 [1.563]
-40	42.10 [1.657]
-49	49.30 [1.941]
-50	50.10 [1.972]
-60	58.10 [2.287]
-70	66.10 [2.602]
-80	74.10 [2.917]
-90	82.10 [3.232]
-100	90.10 [3.547]

FIG 4
 -60 POSITION SHOWN
 (SAME AS FIG 2, EXCEPT AS SHOWN)
USE FOR -09, -13, -25, -37, -40, -49, -50, -60, -70, -80, -90 & -100 POSITIONS WITH -WT & -BL OPTION
-BL TYPE ONLY AVAILABLE WITH -01 CARD
-WT TYPE ONLY AVAILABLE WITH -01 & -03 CARD

PROPRIETARY NOISE
 THIS DOCUMENT CONTAINS CONFIDENTIAL AND PROPRIETARY INFORMATION AND ALL DESIGN, MANUFACTURING, REPRODUCTION, USE, PATENT RIGHTS AND SALES RIGHTS ARE EXPRESSLY RESERVED BY SAMTEC, INC. THIS DOCUMENT SHALL NOT BE DISCLOSED, IN WHOLE OR PART, TO ANY UNAUTHORIZED PERSON OR ENTITY NOR REPRODUCED, TRANSFERRED OR INCORPORATED IN ANY OTHER PROJECT IN ANY MANNER WITHOUT THE EXPRESS WRITTEN CONSENT OF SAMTEC, INC.



520 PARK EAST BLVD, NEW ALBANY, IN 47150
 PHONE: 812-944-6733 FAX: 812-948-5047
 e-Mail: info@SAMTEC.com code: 55322

-L = $\varnothing 0.84 \pm 0.08 [0.033 \pm 0.003]$
 PTH (2 PLCS)
 (TO BE SOLDERED USING
 PASTE-IN-HOLE TECHNOLOGY)

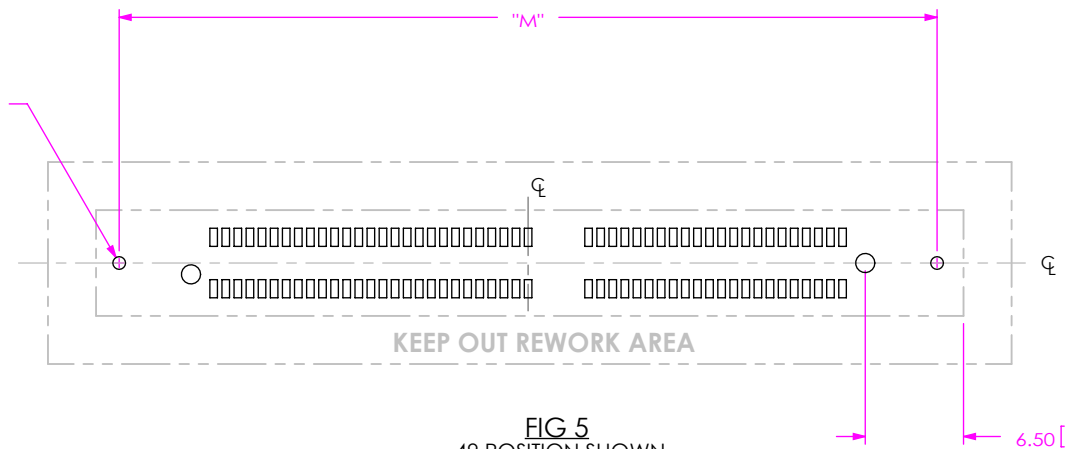

TABLE 6	
POSITION	"M"
-13	25.30 [0.996]
-25	34.90 [1.374]
-37	44.50 [1.752]
-49	54.10 [2.130]

FIG 5
 -49 POSITION SHOWN
 (SAME AS FIG 2, EXCEPT AS SHOWN)
USE FOR -13, -25, -37 & -49 POSITIONS WITH -L OPTION
-L TYPE ONLY AVAILABLE WITH -01 CARD

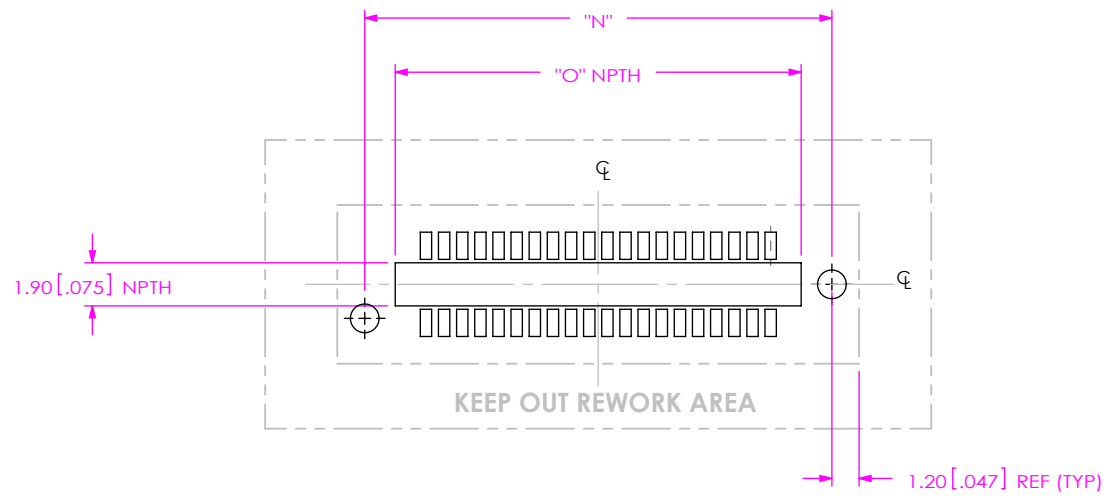

TABLE 7		
POSITION	"N"	"O"
-10	12.60 [0.496]	9.90 [0.390]
-13	15.00 [0.591]	12.30 [0.484]
-20	20.60 [0.811]	17.90 [0.705]

FIG 6
 -20 POSITION SHOWN
 (SAME AS FIG 1, EXCEPT AS SHOWN)
USE FOR -10, 13, OR -20 POSITIONS WITH -PE OPTION
-PE TYPE ONLY AVAILABLE WITH -01 CARD

PROPRIETARY NOTE
 THIS DOCUMENT CONTAINS CONFIDENTIAL AND PROPRIETARY INFORMATION AND ALL DESIGN, MANUFACTURING, REPRODUCTION, USE, PATENT RIGHTS AND SALES RIGHTS ARE EXPRESSLY RESERVED BY SAMTEC, INC. THIS DOCUMENT SHALL NOT BE DISCLOSED, IN WHOLE OR PART, TO ANY UNAUTHORIZED PERSON OR ENTITY NOR REPRODUCED, TRANSFERRED OR INCORPORATED IN ANY OTHER PROJECT IN ANY MANNER WITHOUT THE EXPRESS WRITTEN CONSENT OF SAMTEC, INC.



520 PARK EAST BLVD, NEW ALBANY, IN 47150
 PHONE: 812-944-6733 FAX: 812-948-5047
 e-Mail: info@SAMTEC.com code: 55322

TABLE 8				
POSITION	"P"		"Q"	
-09	18.29	[0.720]	15.79	[0.622]
-13	21.49	[0.846]	18.99	[0.748]
-25	31.09	[1.224]	28.59	[1.126]
-49	50.29	[1.980]	47.79	[1.881]

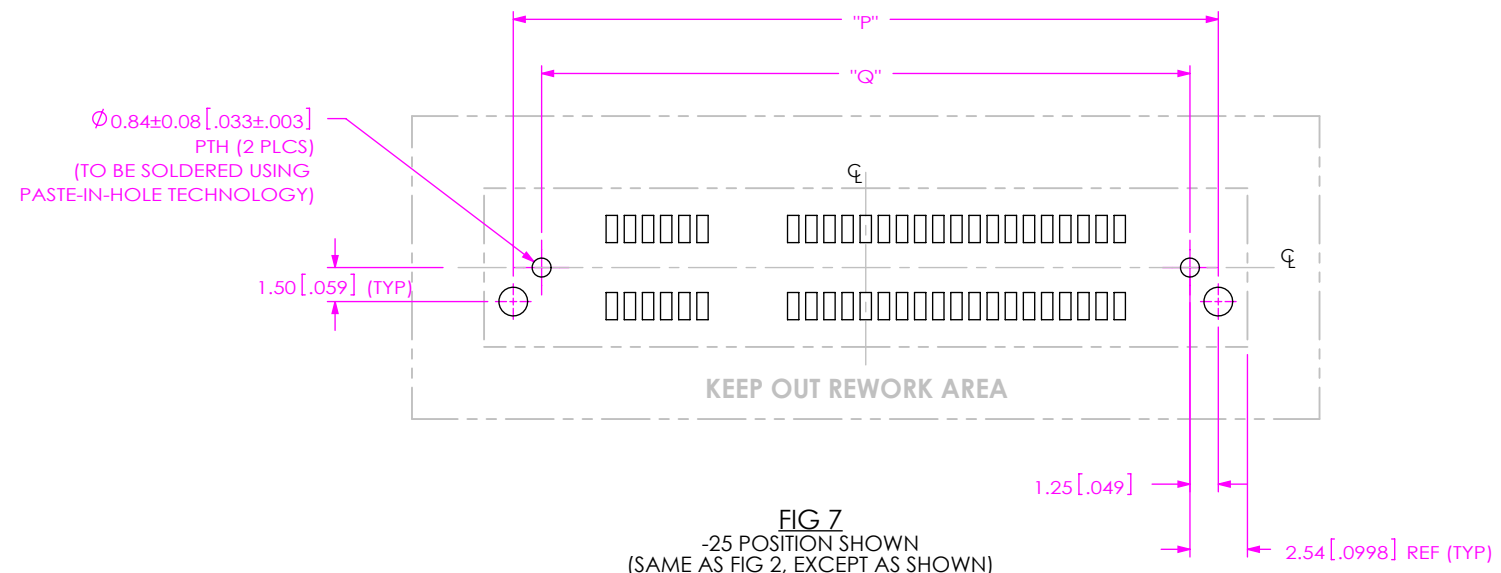

FIG 7
 -25 POSITION SHOWN
 (SAME AS FIG 2, EXCEPT AS SHOWN)
USE FOR -09, -13, -25, OR -49 POSITIONS WITH -L2 OPTION
-L2 TYPE ONLY AVAILABLE WITH -01 CARD

* PROPRIETARY NOTE *
 THIS DOCUMENT CONTAINS CONFIDENTIAL AND PROPRIETARY INFORMATION AND ALL DESIGN, MANUFACTURING, REPRODUCTION, USE, PATENT RIGHTS AND SALES RIGHTS ARE EXPRESSLY RESERVED BY SAMTEC, INC. THIS DOCUMENT SHALL NOT BE DISCLOSED, IN WHOLE OR PART, TO ANY UNAUTHORIZED PERSON OR ENTITY NOR REPRODUCED, TRANSFERRED OR INCORPORATED IN ANY OTHER PRODUCT IN ANY MANNER WITHOUT THE EXPRESS WRITTEN CONSENT OF SAMTEC, INC.



520 PARK EAST BLVD, NEW ALBANY, IN 47150
 PHONE: 812-944-6733 FAX: 812-948-5047
 e-Mail: info@SAMTEC.com code: 55322

NOTE: STENCIL TO BE 0.15[.006] THICK.

TABLE 9	
POSITION	"R"
-13	25.30 [.504]
-25	34.90 [1.374]
-37	44.50[1.752]
-49	54.10 [2.130]

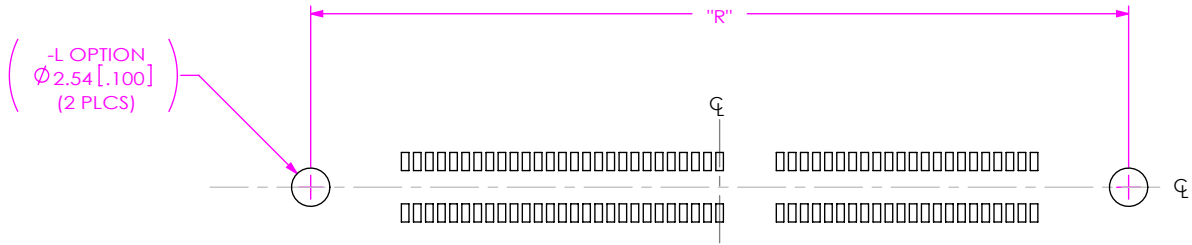

FIG 8
 -49 POSITION SHOWN
 (SAME AS FIG 2, EXCEPT AS SHOWN)
USE FOR -13, -25, -37 & -49 POSITIONS
-L TYPE ONLY AVAILABLE WITH -01 CARD

PROPRIETARY NOTE
 * THIS DOCUMENT CONTAINS CONFIDENTIAL AND PROPRIETARY INFORMATION AND ALL DESIGN, MANUFACTURING, REPRODUCTION, USE, PATENT RIGHTS AND SALES RIGHTS ARE EXPRESSLY RESERVED BY SAMTEC, INC. THIS DOCUMENT SHALL NOT BE DISCLOSED, IN WHOLE OR PART, TO ANY UNAUTHORIZED PERSON OR ENTITY NOR REPRODUCED, TRANSFERRED OR INCORPORATED IN ANY OTHER PROJECT IN ANY MANNER WITHOUT THE EXPRESS WRITTEN CONSENT OF SAMTEC, INC.



520 PARK EAST BLVD, NEW ALBANY, IN 47150
 PHONE: 812-944-6733 FAX: 812-948-5047
 e-Mail: info@SAMTEC.com code: 55322

NOTE: STENCIL TO BE 0.15[.006] THICK.

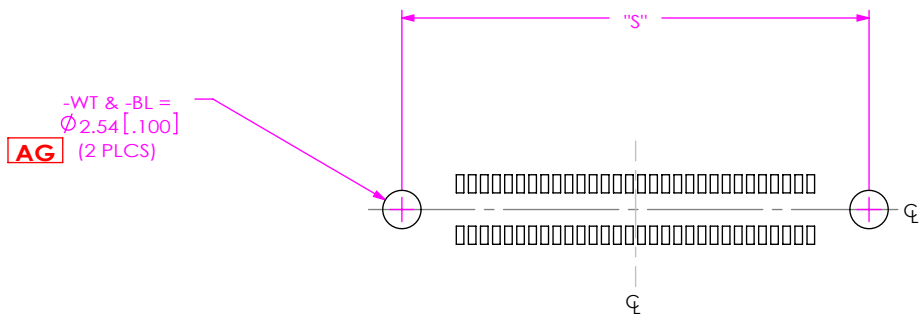

POSITION	"S"
-10	14.90[.587]
-20	22.90[.902]
-30	30.90[1.217]

FIG 9
 -30 POSITION SHOWN
 (SAME AS FIG 1, EXCEPT AS SHOWN)
USE FOR -10, -20 OR -30 POSITIONS WITH -WT & -BL OPTION
-BL TYPE ONLY AVAILABLE WITH -01 CARD
-WT TYPE ONLY AVAILABLE WITH -01 & -03 CARD

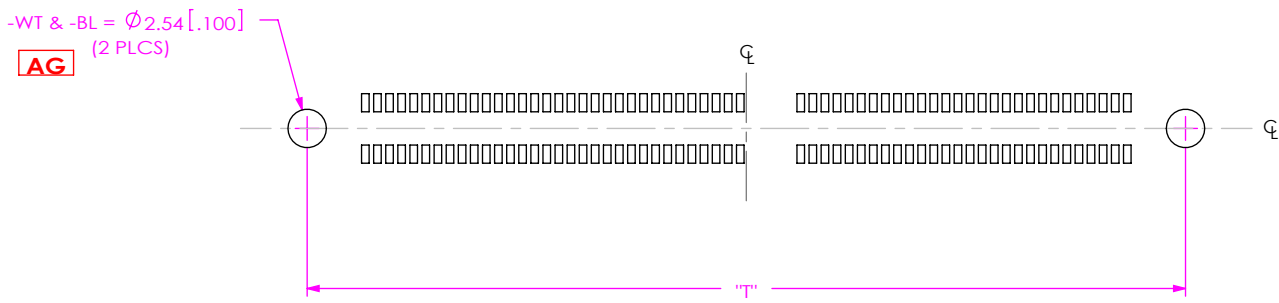

POSITION	"T"
-09	17.30 [0.681]
-13	20.50 [0.807]
-25	30.10 [1.185]
-37	39.70 [1.563]
-40	42.10 [1.657]
-49	49.30 [1.941]
-50	50.10 [1.972]
-60	58.10 [2.287]
-70	66.10 [2.602]
-80	74.10 [2.917]
-90	82.10 [3.232]
-100	90.10 [3.547]

FIG 10
 -60 POSITION SHOWN
 (SAME AS FIG 2, EXCEPT AS SHOWN)
USE FOR -09, -13, -25, -37, -40, -49, -50, -60, -70, -80, -90 & -100 POSITIONS WITH -WT & -BL OPTION
-BL TYPE ONLY AVAILABLE WITH -01 CARD
-WT TYPE ONLY AVAILABLE WITH -01 & -03 CARD

PROPRIETARY NOTE
 THIS DOCUMENT CONTAINS CONFIDENTIAL AND PROPRIETARY INFORMATION AND ALL DESIGN, MANUFACTURING, REPRODUCTION, USE, PATENT RIGHTS AND SALES RIGHTS ARE EXPRESSLY RESERVED BY SAMTEC, INC. THIS DOCUMENT SHALL NOT BE DISCLOSED, IN WHOLE OR PART, TO ANY UNAUTHORIZED PERSON OR ENTITY NOR REPRODUCED, TRANSFERRED OR INCORPORATED IN ANY OTHER PROJECT IN ANY MANNER WITHOUT THE EXPRESS WRITTEN CONSENT OF SAMTEC, INC.



520 PARK EAST BLVD, NEW ALBANY, IN 47150
 PHONE: 812-944-6733 FAX: 812-948-5047
 e-Mail: info@SAMTEC.com code: 55322

NOTE: STENCIL TO BE 0.15[.006] THICK.

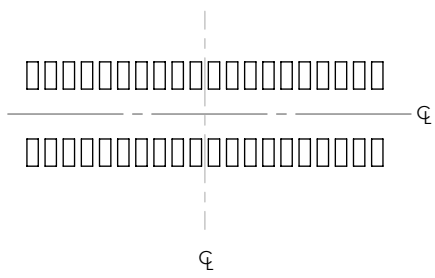

FIG 11
 -20 POSITION SHOWN
 (SAME AS FIG 1, EXCEPT AS SHOWN)
USE FOR -10, 13, OR -20 POSITIONS WITH -PE OPTION
-PE TYPE ONLY AVAILABLE WITH -01 CARD

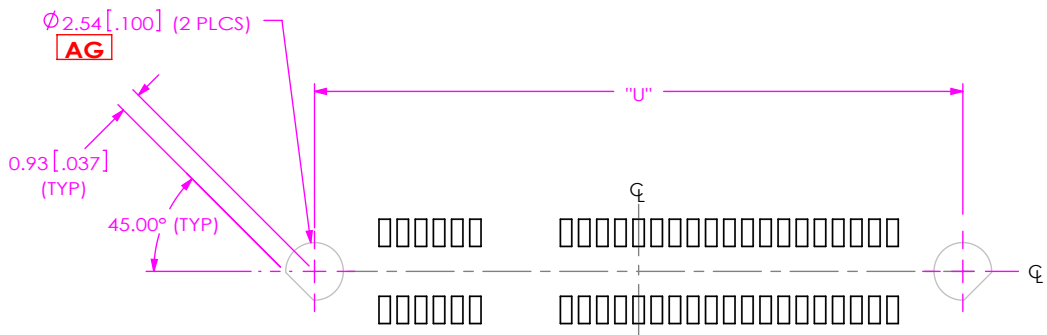

FIG 12
 -25 POSITION SHOWN
 (SAME AS FIG 2, EXCEPT AS SHOWN)
USE FOR -09, -13, -25, OR -49 POSITIONS WITH -L2 OPTION
-L2 TYPE ONLY AVAILABLE WITH -01 CARD

POSITION	"U"
-09	15.79 [0.622]
-13	18.99 [0.748]
-25	28.59 [1.126]
-49	47.79 [1.881]

F:\dwg\misc\mktg\footprnt\HSEC8-1XXX-XX-X-DV-X-FOOTPRINT.SLDDRW

PROPRIETARY NOTE
 THIS DOCUMENT CONTAINS CONFIDENTIAL AND PROPRIETARY INFORMATION AND ALL DESIGN, MANUFACTURING, REPRODUCTION, USE, PATENT RIGHTS AND SALES RIGHTS ARE EXPRESSLY RESERVED BY SAMTEC, INC. THIS DOCUMENT SHALL NOT BE DISCLOSED, IN WHOLE OR PART, TO ANY UNAUTHORIZED PERSON OR ENTITY NOR REPRODUCED, TRANSFERRED OR INCORPORATED IN ANY OTHER PROJECT IN ANY MANNER WITHOUT THE EXPRESS WRITTEN CONSENT OF SAMTEC, INC.



520 PARK EAST BLVD, NEW ALBANY, IN 47150
 PHONE: 812-944-6733 FAX: 812-948-5047
 e-Mail: info@SAMTEC.com code: 55322

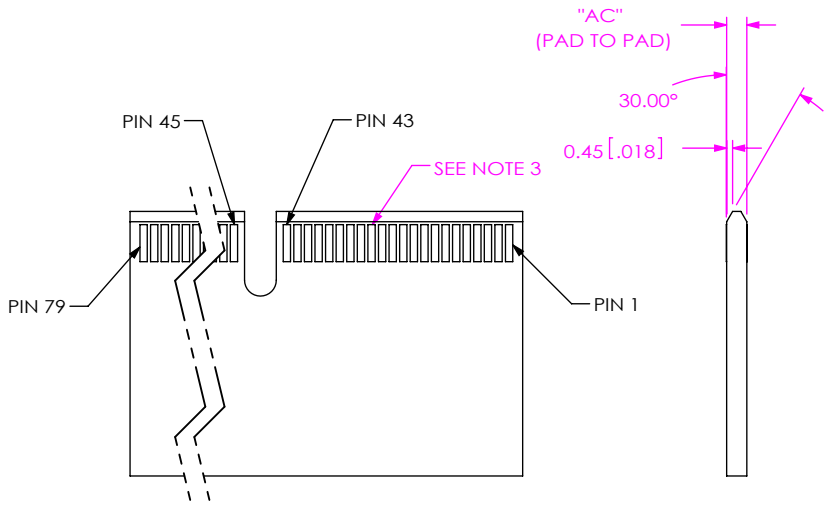

DESIGNED & DIMENSIONED IN MILLIMETERS [ENGLISH]

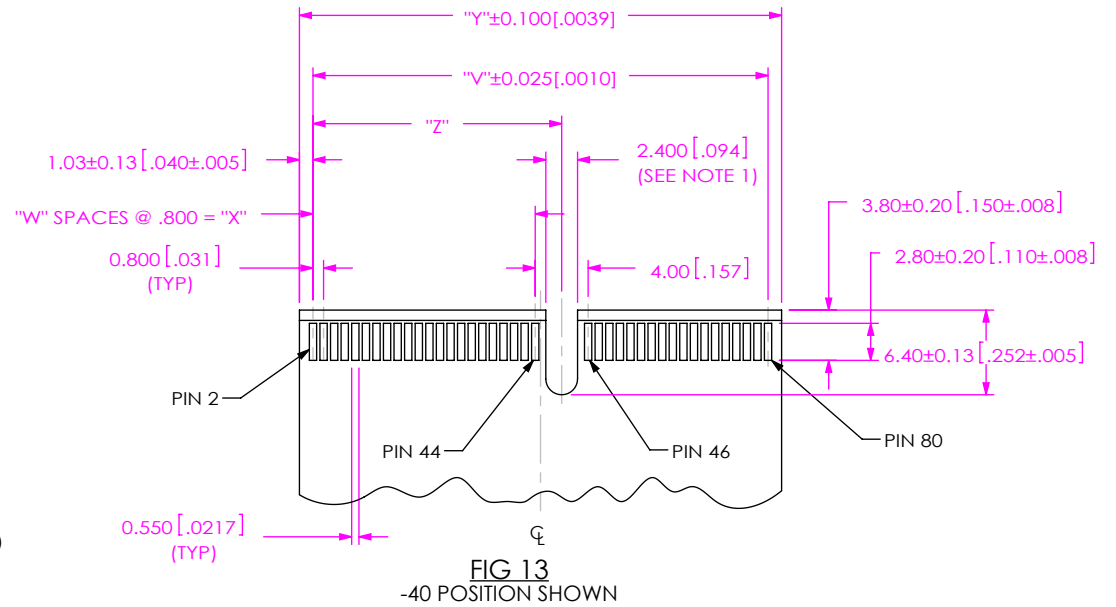
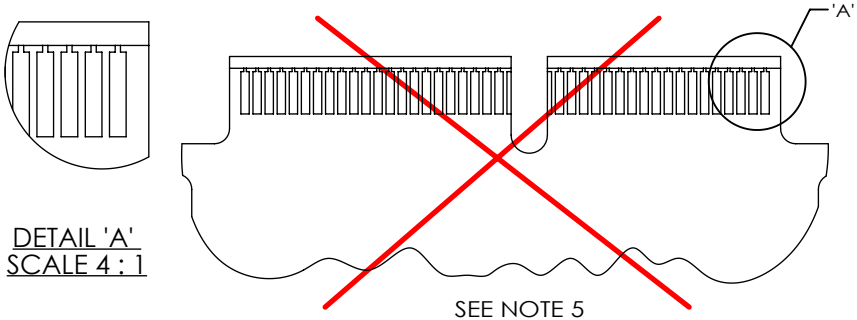

FIG 13
-40 POSITION SHOWN



SEE NOTE 5

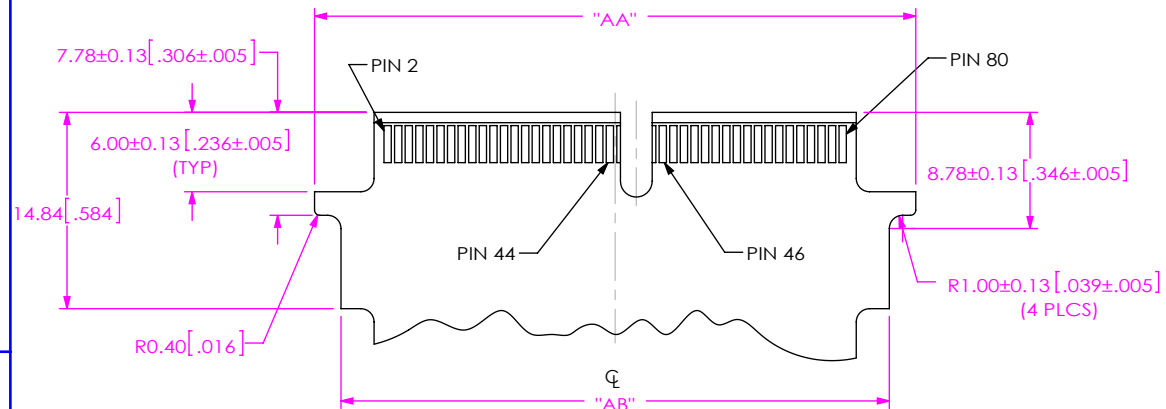

FIG 14
-40 POSITION WITH -BL OPTION SHOWN
(SAME AS FIG 13, EXCEPT AS SHOWN)

NOTES:

1. -10, -20 AND -30 CARDS HAVE NO SLOT.
2. ALL DIMENSIONS ARE SYMMETRIC ABOUT THE CENTERLINE.
3. PLATING TO BE .000030 INCHES GOLD WITH A HARDNESS OF 130-200 KNOOP PER ASTM B 488 TYPE 2, GRADE C.
4. NOTE DELETED.
5. FOR PROPER CONTACT REGISTRATION, PLATING BUS TIES TO BE THE WIDTH OF THE EDGE FINGER.

TABLE 13

POSITION	"V"	"W"	"X"	"Y"	"Z"	"AA"	"AB"
-10	7.20 [0.283]	N/A	N/A	9.25 [0.364]	N/A	18.25 [0.719]	14.25 [0.561]
-13	12.80 [0.504]	5	4.00 [0.157]	14.85 [0.585]	6.00 [0.236]	23.85 [0.939]	19.85 [0.781]
-20	15.20 [0.598]	N/A	N/A	17.25 [0.679]	N/A	26.25 [1.033]	22.25 [0.876]
-25	22.40 [0.882]	5	4.00 [0.157]	24.45 [0.963]	6.00 [0.236]	33.45 [1.317]	29.45 [1.159]
-30	23.20 [0.913]	N/A	N/A	25.25 [0.994]	N/A	34.25 [1.348]	30.25 [1.191]
-37	32.00 [1.260]	20	16.00 [0.630]	34.05 [1.341]	18.00 [0.709]	43.05 [1.695]	39.05 [1.537]
-40	34.40 [1.354]	21	16.80 [0.661]	36.45 [1.435]	18.80 [0.740]	45.45 [1.789]	41.45 [1.632]
-49	41.60 [1.638]	26	20.80 [0.819]	43.65 [1.719]	22.80 [0.898]	52.65 [2.073]	48.65 [1.915]
-50	42.40 [1.669]	26	20.80 [0.819]	44.45 [1.750]	22.80 [0.898]	53.45 [2.104]	49.45 [1.947]
-60	50.40 [1.984]	31	24.80 [0.976]	52.45 [2.065]	26.80 [1.055]	61.45 [2.419]	57.45 [2.262]
-70	58.40 [2.299]	31	24.80 [0.976]	60.45 [2.380]	26.80 [1.055]	69.45 [2.734]	65.45 [2.577]
-80	66.40 [2.614]	31	24.80 [0.976]	68.45 [2.695]	26.80 [1.055]	77.45 [3.049]	73.45 [2.892]
-90	74.40 [2.929]	31	24.80 [0.976]	76.45 [3.010]	26.80 [1.055]	85.45 [3.364]	81.45 [3.207]
-100	82.40 [3.244]	31	24.80 [0.976]	84.45 [3.325]	26.80 [1.055]	93.45 [3.679]	89.45 [3.522]

TABLE 14

MATING CARD THICKNESS TYPE	"AC"
-01	1.570 [0.062] ± 0.157 [0.0062]
-02	2.000 [0.079] ± 0.157 [0.0062]
-03	2.360 [0.093] ± 0.157 [0.0062]
*-04	3.180 [0.125] ± 0.157 [0.0062]

*= NOT TOOLED

F:\dwtg\misc\mktg\footprint\HSEC8-1XXX-XX-X-D-DV-X-FOOTPRINT.SLDDRW

PROPRIETARY NOTE
THIS DOCUMENT CONTAINS CONFIDENTIAL AND PROPRIETARY INFORMATION AND ALL DESIGN, MANUFACTURING, REPRODUCTION, USE, PATENT RIGHTS AND SALES RIGHTS ARE EXPRESSLY RESERVED BY SAMTEC, INC. THIS DOCUMENT SHALL NOT BE DISCLOSED, IN WHOLE OR PART, TO ANY UNAUTHORIZED PERSON OR ENTITY NOR REPRODUCED, TRANSFERRED OR INCORPORATED IN ANY OTHER PROJECT IN ANY MANNER WITHOUT THE EXPRESS WRITTEN CONSENT OF SAMTEC, INC.



520 PARK EAST BLVD, NEW ALBANY, IN 47150
PHONE: 812-944-6733 FAX: 812-948-5047
e-Mail: info@SAMTEC.com code: 55322

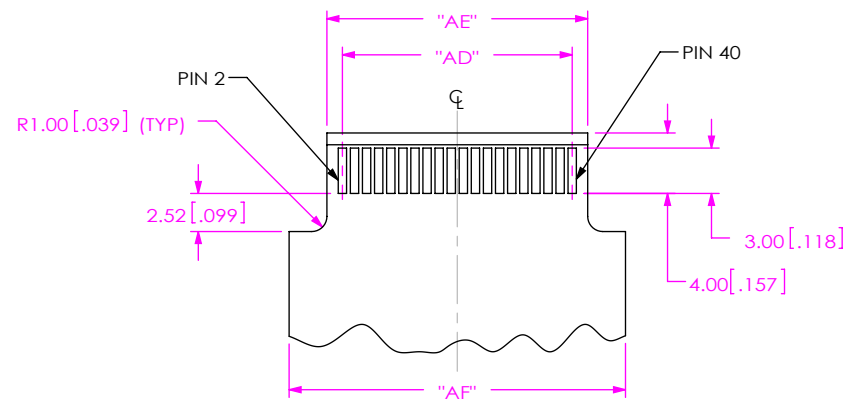

SEE NOTE 5

FIG 15

-20 POSITION SHOWN

(SAME AS FIG 13 EXCEPT AS SHOWN)

USE FOR -10, -13, OR -20 POSITIONS WITH -PE OPTION WITH CUTOUTS IN THE BOARD, TOP ENTRY

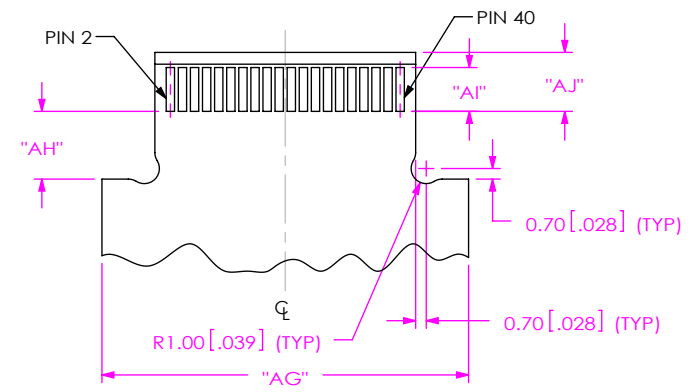

SEE NOTE 5

FIG 16

-20 POSITION SHOWN

(SAME AS FIG 15 EXCEPT AS SHOWN)

USE FOR -10, 13, OR -20 POSITIONS WITH -PE OPTION WITH CUTOUTS IN THE BOARD, BOTTOM ENTRY

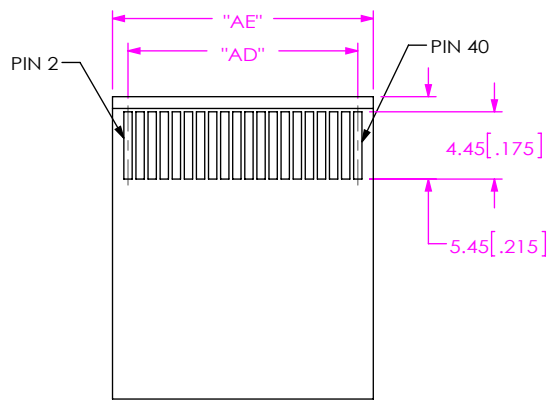

FIG 17

-20 POSITION SHOWN

(SAME AS FIG 13, EXCEPT AS SHOWN)

USE FOR -10, 13, OR -20 POSITIONS WITH -PE OPTION WITHOUT CUTOUTS IN THE BOARD

TABLE 16

SUBSTRATE THICKNESS	"AH"	"AI"	"AJ"
1.57 [.062]	4.48 [0.176]	2.90 [0.114]	3.90 [0.154]
2.36 [.093]	5.33 [0.210]	3.05 [0.120]	4.05 [0.159]
3.18 [.125]	6.20 [0.244]	3.20 [0.126]	4.20 [0.165]

TABLE 15

POSITION	"AD"	"AE"	"AF"	"AG"
-10	7.20 [0.283]	9.25 [0.364]	14.25 [0.561]	16.25 [0.640]
-13	9.60 [0.378]	11.65 [0.459]	16.65 [0.656]	18.65 [0.734]
-20	15.20 [0.598]	17.25 [0.679]	22.25 [0.876]	24.25 [0.955]

NOTES:

1. ALL DIMENSIONS ARE SYMMETRIC ABOUT THE CENTERLINE.
2. PLATING TO BE .000030 INCHES GOLD WITH A HARDNESS OF 130-200 KNOOP PER ASTM B 488 TYPE 2, GRADE C.
3. NOTE DELETED.
4. FOR PROPER CONTACT REGISTRATION, PLATING BUS TIES TO BE THE WIDTH OF THE EDGE FINGER.
5. MIN REQUIRED LENGTH.

F:\dwg\misc\mktg\footprint\HSEC8-1XXX-XX-X-D-DV-X-FOOTPRINT.SLDDRW

DETAIL 'A'
SCALE 4 : 1

SEE NOTE 4

PROPRIETARY NOTE

THIS DOCUMENT CONTAINS CONFIDENTIAL AND PROPRIETARY INFORMATION AND ALL DESIGN, MANUFACTURING, REPRODUCTION, USE, PATENT RIGHTS AND SALES RIGHTS ARE EXPRESSLY RESERVED BY SAMTEC, INC. THIS DOCUMENT SHALL NOT BE DISCLOSED, IN WHOLE OR PART, TO ANY UNAUTHORIZED PERSON OR ENTITY NOR REPRODUCED, TRANSFERRED OR INCORPORATED IN ANY OTHER PRODUCT IN ANY MANNER WITHOUT THE EXPRESS WRITTEN CONSENT OF SAMTEC, INC.

520 PARK EAST BLVD, NEW ALBANY, IN 47150
 PHONE: 812-944-6733 FAX: 812-948-5047
 e-Mail: info@SAMTEC.com code: 55322