



STD100N3LF3

N-channel 30 V, 0.0045 Ω , 80 A, DPAK
planar STripFET™ II Power MOSFET

Features

Type	V _{DSSS}	R _{DS(on)}	I _D	P _w
STD100N3LF3	30 V	<0.0055 Ω	80 A ⁽¹⁾	110 W

1. Current limited by package

- 100% avalanche tested
- Logic level threshold

Applications

- Switching application
 - Automotive

Description

This STripFET™ II Power MOSFET technology is among the latest improvements, which have been especially tailored to minimize on-state resistance providing superior switching performance.

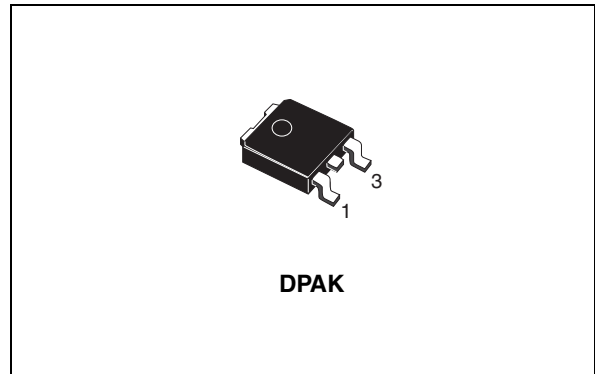

Figure 1. Internal schematic diagram

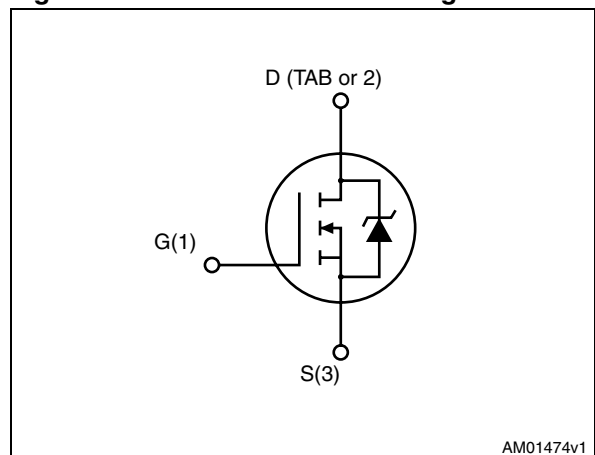

Table 1. Device summary

Order codes	Marking	Package	Packaging
STD100N3LF3	100N3LF3	DPAK	Tape and reel

Contents

1	Electrical ratings	3
2	Electrical characteristics	4
2.1	Electrical characteristics (curves)	6
3	Test circuits	9
4	Package mechanical data	10
5	Packaging mechanical data	13
6	Revision history	14

1 Electrical ratings

Table 2. Absolute maximum ratings

Symbol	Parameter	Value	Unit
V_{DS}	Drain-source voltage ($V_{GS} = 0$)	30	V
V_{GS}	Gate-source voltage	± 20	V
$I_D^{(1)}$	Drain current (continuous) at $T_C = 25\text{ }^\circ\text{C}$	80	A
I_D	Drain current (continuous) at $T_C=100\text{ }^\circ\text{C}$	70	A
$I_{DM}^{(2)}$	Drain current (pulsed)	320	A
P_{TOT}	Total dissipation at $T_C = 25\text{ }^\circ\text{C}$	110	W
	Derating factor	0.73	W/ $^\circ\text{C}$
$dv/dt^{(3)}$	Peak diode recovery voltage slope	3.9	V/ns
T_{stg}	Storage temperature	-55 to 175	$^\circ\text{C}$
T_J	Max. operating junction temperature		

1. Current limited by package.
2. Pulse width limited by safe operating area
3. $I_{SD} \leq 80\text{A}$, $di/dt \leq 360\text{ A}/\mu\text{s}$, $V_{DS} \leq V_{(BR)DSS}$, $T_J \leq T_{JMAX}$

Table 3. Thermal data

Symbol	Parameter	Value	Unit
R_{thJC}	Thermal resistance junction-case max	1.36	$^\circ\text{C}/\text{W}$
R_{thJA}	Thermal resistance junction-ambient max	100	$^\circ\text{C}/\text{W}$
T_I	Maximum lead temperature for soldering purpose	275	$^\circ\text{C}$

Table 4. Avalanche characteristics

Symbol	Parameter	Value	Unit
I_{AR}	Not-repetitive avalanche current (pulse width limited by T_J max)	40	A
E_{AS}	Single pulsed avalanche energy (starting $T_J = 25\text{ }^\circ\text{C}$, $I_D = I_{AV}$, $V_{DD} = 24\text{ V}$)	500	mJ

2 Electrical characteristics

(T_{CASE}=25°C unless otherwise specified)

Table 5. On/off states

Symbol	Parameter	Test conditions	Min.	Typ.	Max.	Unit
V _{(BR)DSS}	Drain-source breakdown voltage	I _D = 250 μA, V _{GS} = 0	30			V
I _{DSS}	Zero gate voltage drain current (V _{GS} = 0)	V _{DS} = Max rating, V _{DS} = Max rating @ 125 °C			1 10	μA μA
I _{GSS}	Gate body leakage current (V _{DS} = 0)	V _{GS} = ±20 V			±200	nA
V _{GS(th)}	Gate threshold voltage	V _{DS} = V _{GS} , I _D = 250 μA	1		2.5	V
R _{DS(on)}	Static drain-source on resistance	V _{GS} = 10 V, I _D = 40 A		0.0045	0.0055	Ω
		V _{GS} = 5 V, I _D = 20 A		0.008	0.01	Ω
		V _{GS} = 10 V, I _D = 40 A @ 125 °C		0.0068		Ω
		V _{GS} = 5 V, I _D = 20 A @ 125 °C		0.0146		Ω

Table 6. Dynamic

Symbol	Parameter	Test conditions	Min.	Typ.	Max.	Unit
g _{fs} ⁽¹⁾	Forward transconductance	V _{DS} = 10 V, I _D = 15 A	-	31		S
C _{iss} C _{oss} C _{rss}	Input capacitance Output capacitance Reverse transfer capacitance	V _{DS} = 25 V, f = 1 MHz, V _{GS} = 0	-	2060 728 67		pF pF pF
Q _g Q _{gs} Q _{gd}	Total gate charge Gate-source charge Gate-drain charge	V _{DD} = 24 V, I _D = 80 A V _{GS} = 5 V <i>Figure 16 on page 9</i>	-	20 7 7.5	27	nC nC nC
R _G	Gate input resistance	f = 1 MHz gate DC Bias = 0 test signal level = 20 mV open drain	-	1.9		Ω

1. Pulsed: pulse duration=300μs, duty cycle 1.5%

Table 7. Switching times

Symbol	Parameter	Test conditions	Min.	Typ.	Max.	Unit
$t_{d(on)}$	Turn-on delay time	$V_{DD} = 15\text{ V}$, $I_D = 40\text{ A}$, $R_G = 4.7\ \Omega$, $V_{GS} = 10\text{ V}$ Figure 15 on page 9	-	9	-	ns
t_r	Rise time		-	205	-	ns
$t_{d(off)}$	Turn-off delay time		-	31	-	ns
t_f	Fall time		-	35	-	ns

Table 8. Source drain diode

Symbol	Parameter	Test conditions	Min	Typ.	Max	Unit
I_{SD}	Source-drain current		-		80	A
$I_{SDM}^{(1)}$	Source-drain current (pulsed)		-		320	A
$V_{SD}^{(2)}$	Forward on voltage	$I_{SD} = 40\text{ A}$, $V_{GS} = 0$	-		1.3	V
t_{rr}	Reverse recovery time	$I_{SD} = 80\text{ A}$, $di/dt = 100\text{ A}/\mu\text{s}$, $V_{DD} = 25\text{ V}$, $T_J = 150\text{ }^\circ\text{C}$ Figure 17 on page 9	-	40		ns
Q_{rr}	Reverse recovery charge		-	40		μC
I_{RRM}	Reverse recovery current		-	2		A

1. Pulse width limited by safe operating area
2. Pulsed: pulse duration=300 μs , duty cycle 1.5%

2.1 Electrical characteristics (curves)

Figure 2. Safe operating area

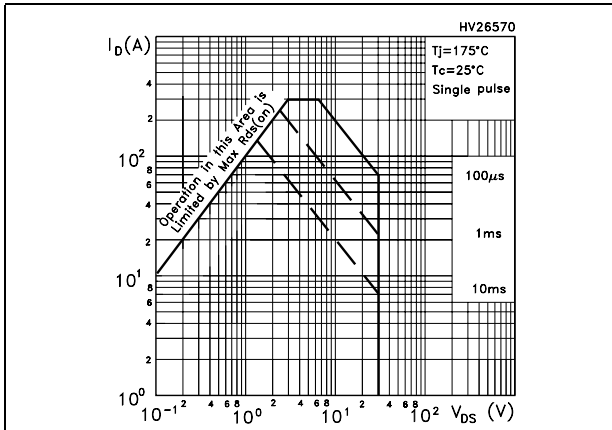

Figure 3. Thermal impedance

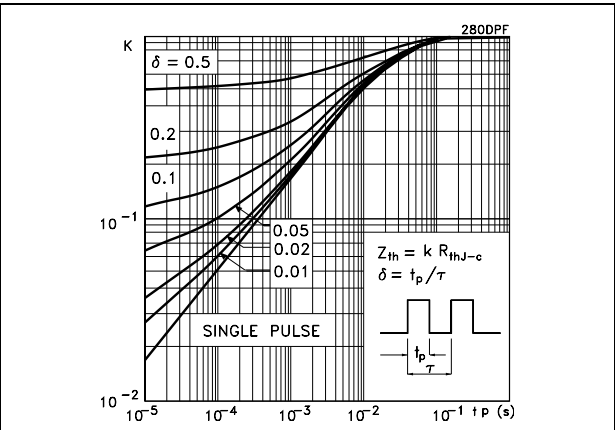

Figure 4. Output characteristics

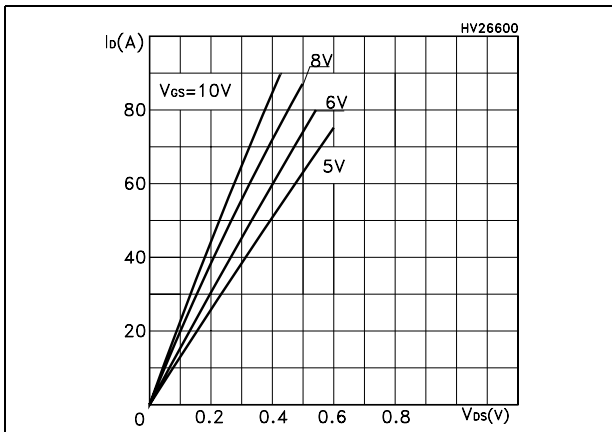

Figure 5. Transfer characteristics

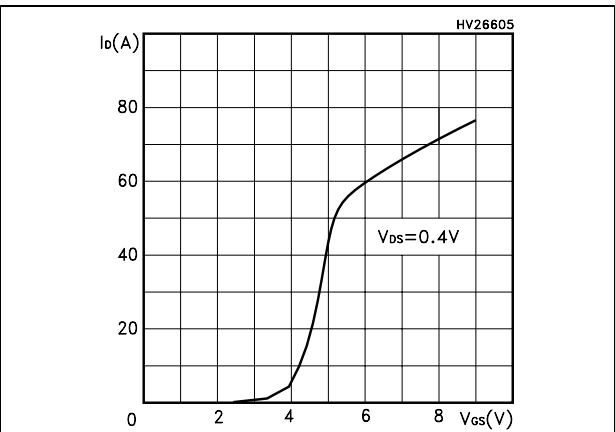

Figure 6. Transconductance

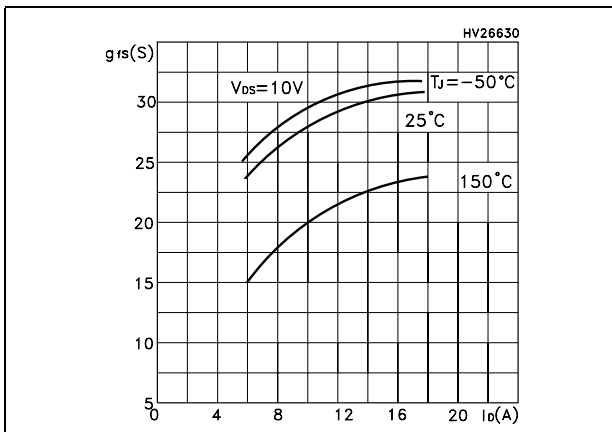

Figure 7. Static drain-source on resistance

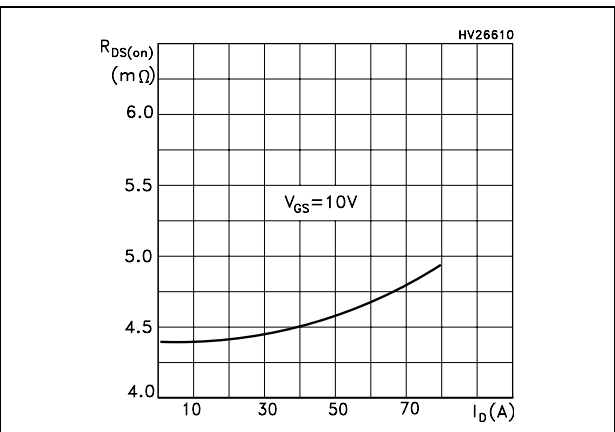

Figure 8. Gate charge vs gate-source voltage Figure 9. Capacitance variations

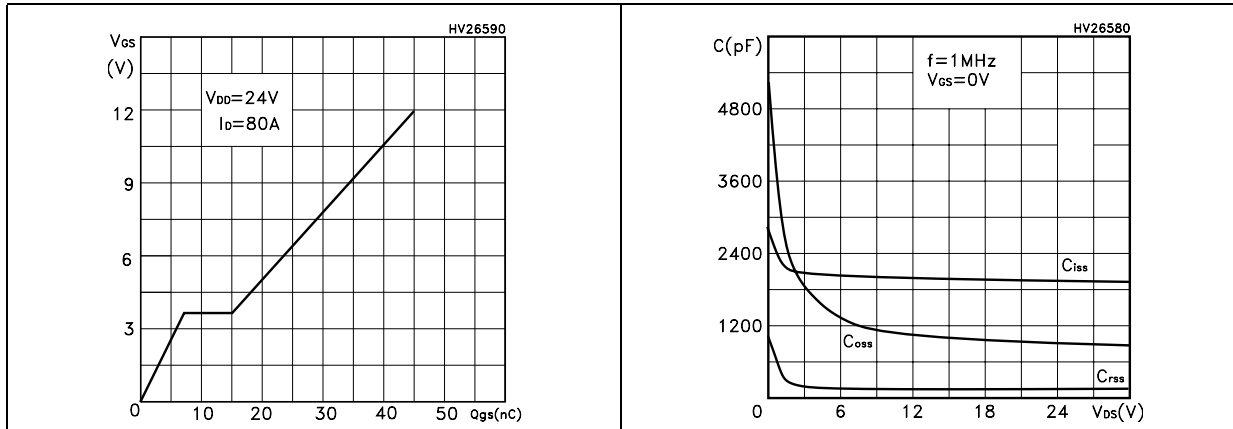

Figure 10. Normalized gate threshold voltage vs temperature Figure 11. Normalized BV_{DSS} vs temperature

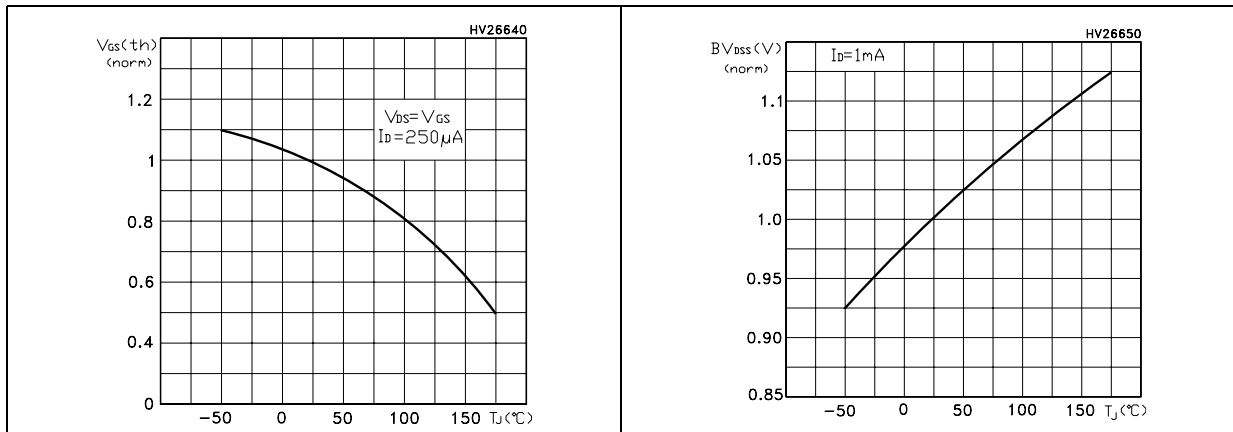

Figure 12. Normalized on resistance vs temperature Figure 13. Source-drain diode forward characteristics

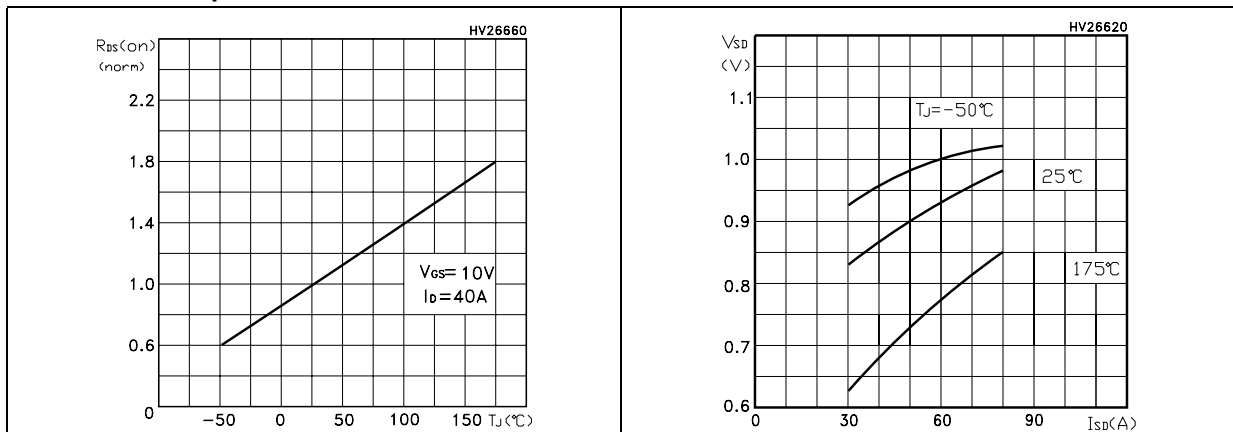
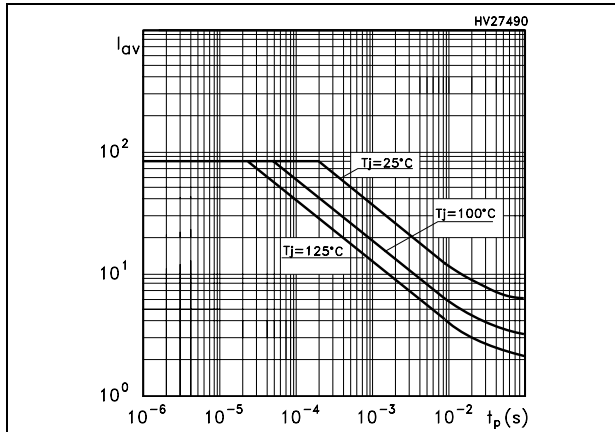

Figure 14. Allowable I_{AV} vs time in avalanche



The previous curve gives the single pulse safe operating area for unclamped inductive loads, under the following conditions:

$$P_{D(AVE)} = 0.5 * (1.3 * BV_{DSS} * I_{AV})$$

$$E_{AS(AR)} = P_{D(AVE)} * t_{AV}$$

Where:

I_{AV} is the allowable current in avalanche

$P_{D(AVE)}$ is the average power dissipation in avalanche (single pulse)

t_{AV} is the time in avalanche

3 Test circuits

Figure 15. Switching times test circuit for resistive load



Figure 16. Gate charge test circuit



Figure 17. Test circuit for inductive load switching and diode recovery times

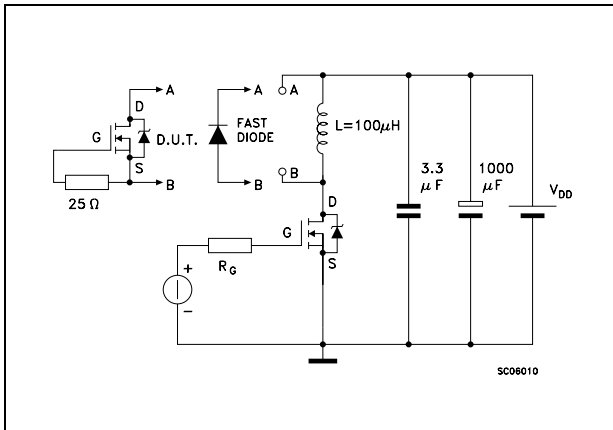

4 Package mechanical data

In order to meet environmental requirements, ST offers these devices in different grades of ECOPACK[®] packages, depending on their level of environmental compliance. ECOPACK[®] specifications, grade definitions and product status are available at: www.st.com. ECOPACK is an ST trademark.

TO-252 (DPAK) mechanical data

DIM.	mm.		
	min.	typ	max.
A	2.20		2.40
A1	0.90		1.10
A2	0.03		0.23
b	0.64		0.90
b4	5.20		5.40
c	0.45		0.60
c2	0.48		0.60
D	6.00		6.20
D1		5.10	
E	6.40		6.60
E1		4.70	
e		2.28	
e1	4.40		4.60
H	9.35		10.10
L	1		
L1		2.80	
L2		0.80	
L4	0.60		1
R		0.20	
V2	0°		8°

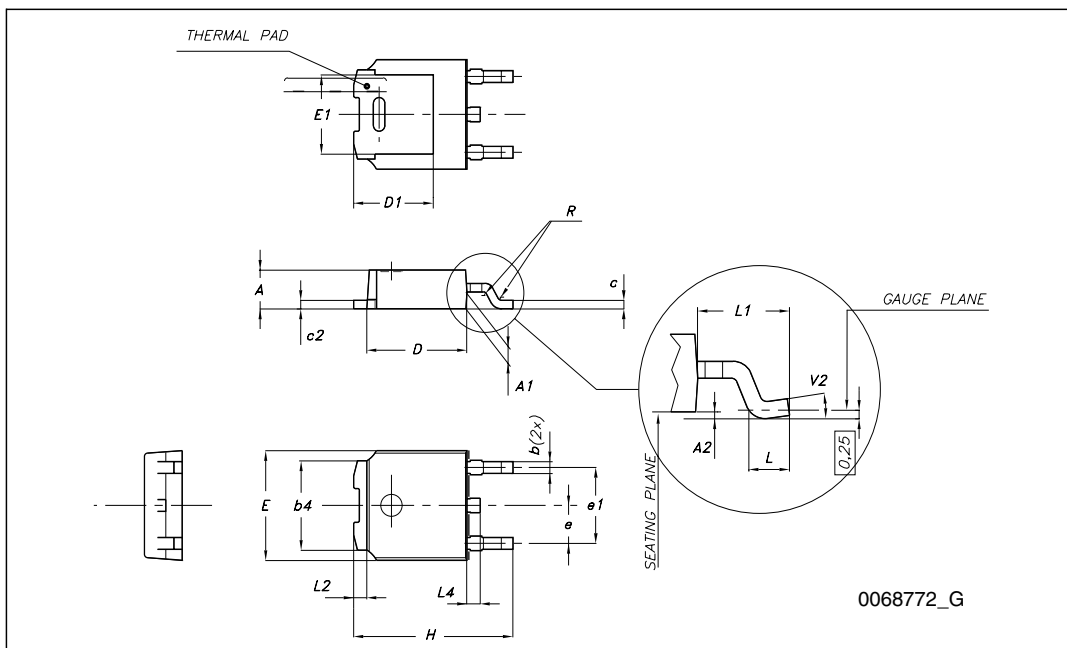

5 Packaging mechanical data

DPAK FOOTPRINT

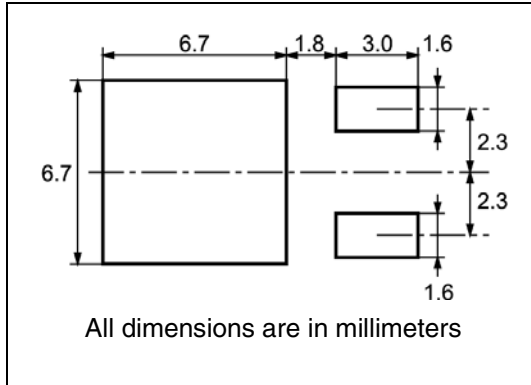

TAPE AND REEL SHIPMENT

TAPE MECHANICAL DATA

DIM.	mm		inch	
	MIN.	MAX.	MIN.	MAX.
A0	6.8	7	0.267	0.275
B0	10.4	10.6	0.409	0.417
B1		12.1		0.476
D	1.5	1.6	0.059	0.063
D1	1.5		0.059	
E	1.65	1.85	0.065	0.073
F	7.4	7.6	0.291	0.299
K0	2.55	2.75	0.100	0.108
P0	3.9	4.1	0.153	0.161
P1	7.9	8.1	0.311	0.319
P2	1.9	2.1	0.075	0.082
R	40		1.574	
W	15.7	16.3	0.618	0.641

REEL MECHANICAL DATA

DIM.	mm		inch	
	MIN.	MAX.	MIN.	MAX.
A		330		12.992
B	1.5		0.059	
C	12.8	13.2	0.504	0.520
D	20.2		0.795	
G	16.4	18.4	0.645	0.724
N	50		1.968	
T		22.4		0.881

BASE QTY	BULK QTY
2500	2500

6 Revision history

Table 9. Document revision history

Date	Revision	Changes
07-Feb-2006	1	Initial release.
07-May-2009	2	Added $V_{GS(th)}$ max value in Table 5: On/off states
09-Nov-2009	3	Added V_{GS} parameter in Table 2: Absolute maximum ratings

Please Read Carefully:

Information in this document is provided solely in connection with ST products. STMicroelectronics NV and its subsidiaries ("ST") reserve the right to make changes, corrections, modifications or improvements, to this document, and the products and services described herein at any time, without notice.

All ST products are sold pursuant to ST's terms and conditions of sale.

Purchasers are solely responsible for the choice, selection and use of the ST products and services described herein, and ST assumes no liability whatsoever relating to the choice, selection or use of the ST products and services described herein.

No license, express or implied, by estoppel or otherwise, to any intellectual property rights is granted under this document. If any part of this document refers to any third party products or services it shall not be deemed a license grant by ST for the use of such third party products or services, or any intellectual property contained therein or considered as a warranty covering the use in any manner whatsoever of such third party products or services or any intellectual property contained therein.

UNLESS OTHERWISE SET FORTH IN ST'S TERMS AND CONDITIONS OF SALE ST DISCLAIMS ANY EXPRESS OR IMPLIED WARRANTY WITH RESPECT TO THE USE AND/OR SALE OF ST PRODUCTS INCLUDING WITHOUT LIMITATION IMPLIED WARRANTIES OF MERCHANTABILITY, FITNESS FOR A PARTICULAR PURPOSE (AND THEIR EQUIVALENTS UNDER THE LAWS OF ANY JURISDICTION), OR INFRINGEMENT OF ANY PATENT, COPYRIGHT OR OTHER INTELLECTUAL PROPERTY RIGHT.

UNLESS EXPRESSLY APPROVED IN WRITING BY AN AUTHORIZED ST REPRESENTATIVE, ST PRODUCTS ARE NOT RECOMMENDED, AUTHORIZED OR WARRANTED FOR USE IN MILITARY, AIR CRAFT, SPACE, LIFE SAVING, OR LIFE SUSTAINING APPLICATIONS, NOR IN PRODUCTS OR SYSTEMS WHERE FAILURE OR MALFUNCTION MAY RESULT IN PERSONAL INJURY, DEATH, OR SEVERE PROPERTY OR ENVIRONMENTAL DAMAGE. ST PRODUCTS WHICH ARE NOT SPECIFIED AS "AUTOMOTIVE GRADE" MAY ONLY BE USED IN AUTOMOTIVE APPLICATIONS AT USER'S OWN RISK.

Resale of ST products with provisions different from the statements and/or technical features set forth in this document shall immediately void any warranty granted by ST for the ST product or service described herein and shall not create or extend in any manner whatsoever, any liability of ST.

ST and the ST logo are trademarks or registered trademarks of ST in various countries.

Information in this document supersedes and replaces all information previously supplied.

The ST logo is a registered trademark of STMicroelectronics. All other names are the property of their respective owners.

© 2009 STMicroelectronics - All rights reserved

STMicroelectronics group of companies

Australia - Belgium - Brazil - Canada - China - Czech Republic - Finland - France - Germany - Hong Kong - India - Israel - Italy - Japan - Malaysia - Malta - Morocco - Philippines - Singapore - Spain - Sweden - Switzerland - United Kingdom - United States of America

www.st.com