

400° ANALOG PHASE SHIFTER 1 - 2 GHz



Typical Applications

The HMC934LP5E is ideal for:

- EW Receivers
- Military Radar
- Test Equipment
- Satellite Communications
- Beam Forming Modules

Functional Diagram

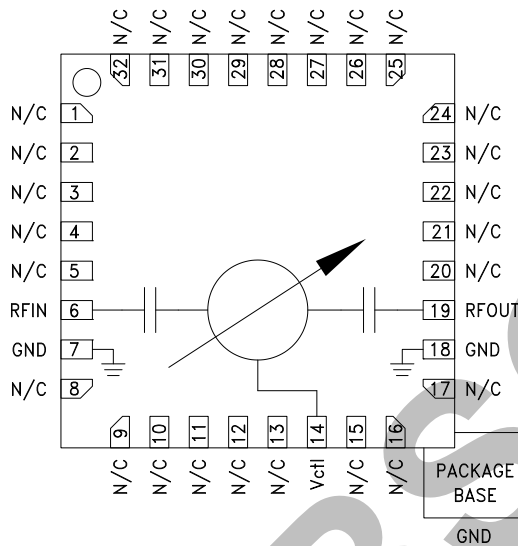

Features

- Octave Bandwidth: 1 to 2 GHz
- 400° Phase Shift
- Low Insertion Loss: 3.5 dB
- Low Phase Error: +3.5 / -2 deg
- Single Positive Voltage Control
- 32 Lead 5 x 5 mm QFN Package: 25 mm²

General Description

The HMC934LP5E is an Analog Phase Shifter which is controlled via an analog control voltage from 0 to +13V. The HMC934LP5E provides a continuously variable phase shift of 0 to 400 degrees from 1 to 2 GHz, with extremely consistent low insertion loss versus phase shift and frequency. The high accuracy HMC934LP5E is monotonic with respect to control voltage and features a typical low phase error of +3.5 / -2 degrees. The HMC934LP5E is housed in an RoHS compliant 5 x 5 mm QFN leadless package.

Electrical Specifications, $T_A = +25^\circ\text{C}$, 50 Ohm System

Parameter	Min.	Typ.	Max.	Units
Frequency Range	1		2	GHz
Phase Shift Range		400		deg
Insertion Loss		3.5		dB
Return Loss (input and output)		15		dB
Control Voltage Range	0		13	V
Control Current Range			±1	mA
Input IP3		30		dBm
Input Power @ -5° Shift In Insertion Phase (Vctl = 0V)		9		dBm
Input Power @ -5° Shift In Insertion Phase (Vctl = 0.5V)		13		dBm
Input Power @ -2° shift In Insertion Phase (Vctl = 13V)		16		dBm
Phase Voltage Sensitivity		32		deg/V
Phase Error (peak) ^[1]		+9 / -5		deg
Phase Error (average) ^[1]		+3.5 / -2		deg
Modulation Bandwidth		6		MHz
Insertion Phase Temperature Sensitivity		0.16		deg/°C

[1] Up to a phase shift of 360 degrees.



**400° ANALOG PHASE SHIFTER
1 - 2 GHz**

Insertion Loss vs. Frequency

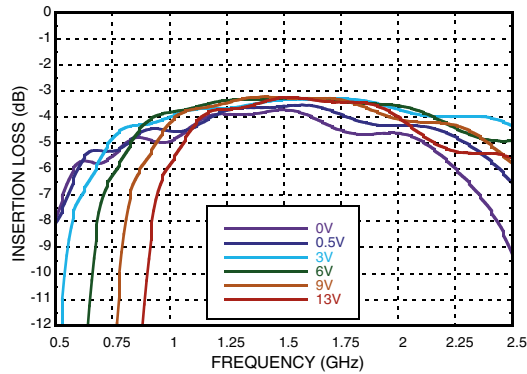

Insertion Loss vs. Vctl , F = 1.5 GHz

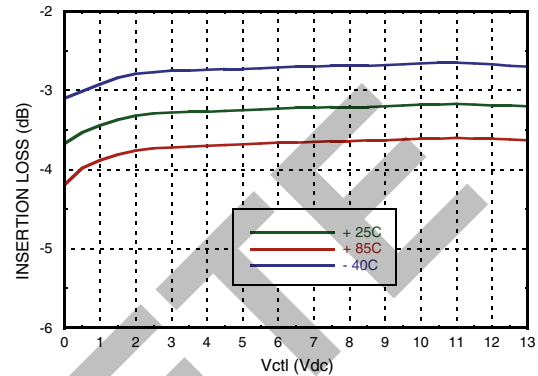

Phase Shift vs. Vctl

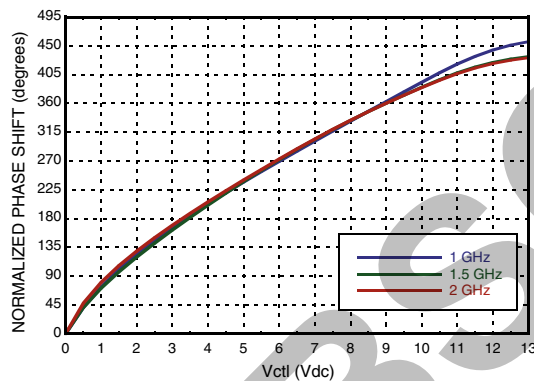

**Phase Shift vs. Frequency
@ Vctl = 6V (Relative to Vctl = 0V)**

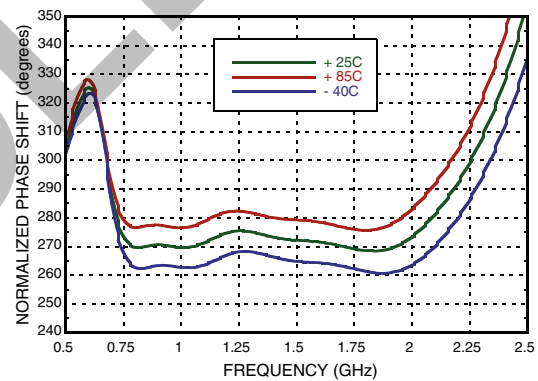

**Phase Shift vs. Frequency
(Relative to Vctl = 0V) Vctl = 0 to 13V**

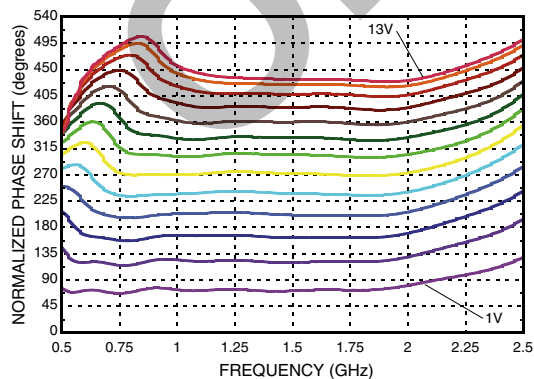

**Phase Error vs.
Frequency, Fmean = 1.5 GHz [1]**

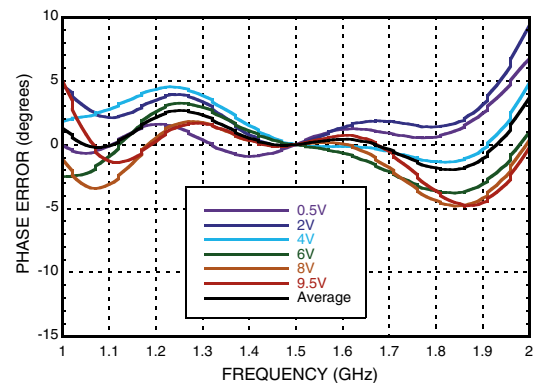

[1] 0 to 9.5V provides 0 - 360 degrees phase shift range



**400° ANALOG PHASE SHIFTER
1 - 2 GHz**

Second Harmonic vs. Vctl, F = 1.5 GHz

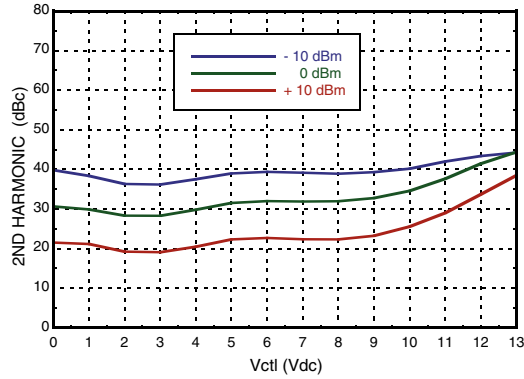

Third Harmonic vs. Vctl, F = 1.5 GHz

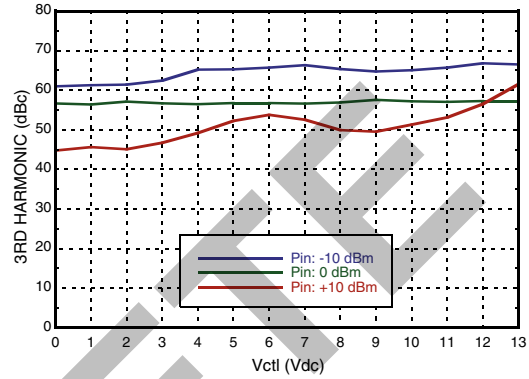

Input IP3 vs. Vctl, F = 1.5 GHz

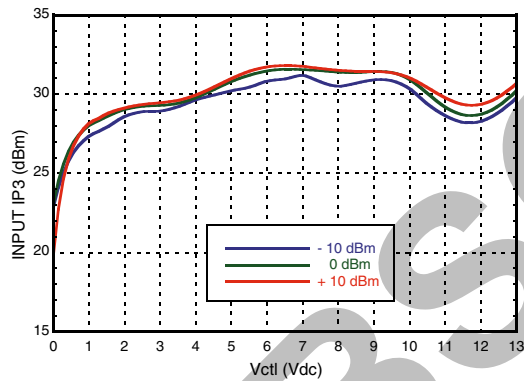

Insertion Loss vs. Pin @ 1 GHz

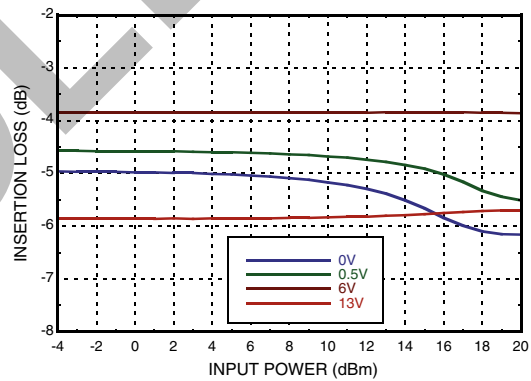

Insertion Loss vs. Pin @ 1.5 GHz

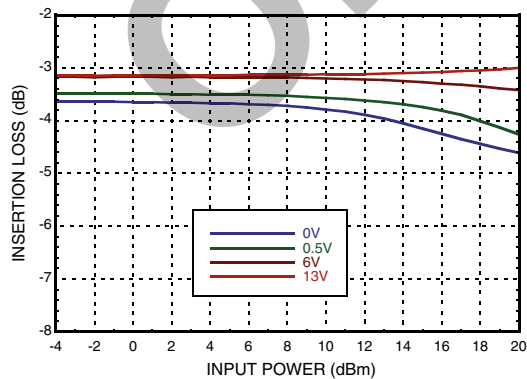

Insertion Loss vs. Pin @ 2 GHz

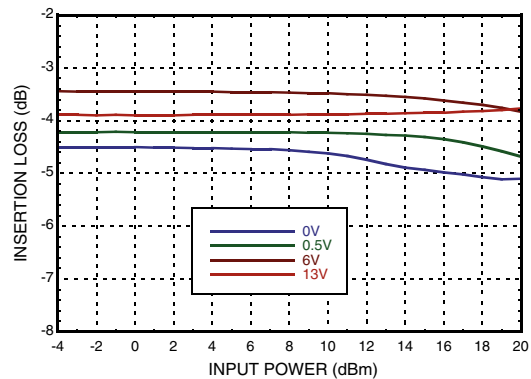

Information furnished by Analog Devices is believed to be accurate and reliable. However, no responsibility is assumed by Analog Devices for its use, nor for any infringements of patents or other rights of third parties that may result from its use. Specifications subject to change without notice. No license is granted by implication or otherwise under any patent or patent rights of Analog Devices. Trademarks and registered trademarks are the property of their respective owners.

For price, delivery, and to place orders: Analog Devices, Inc., One Technology Way, P.O. Box 9106, Norwood, MA 02062-9106 Phone: 781-329-4700 • Order online at www.analog.com Application Support: Phone: 1-800-ANALOG-D



**400° ANALOG PHASE SHIFTER
1 - 2 GHz**

Phase Shift vs. Pin @ 1 GHz

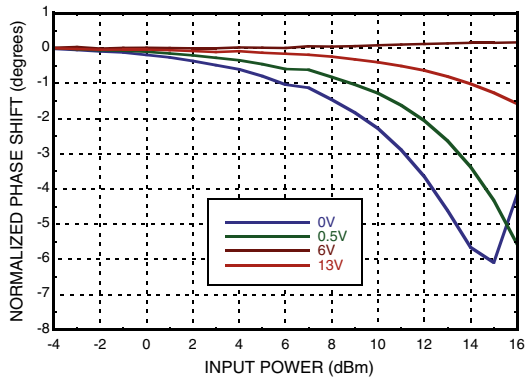

Phase Shift vs. Pin @ 1.5 GHz

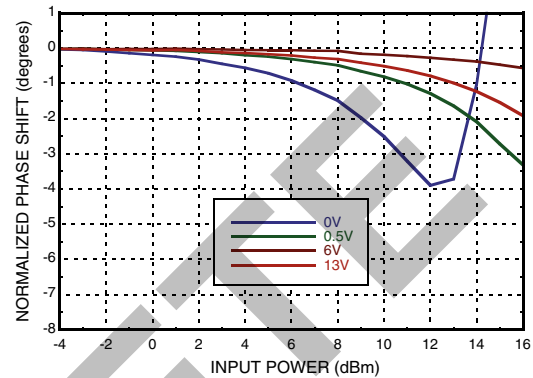

Phase Shift vs. Pin @ 2 GHz

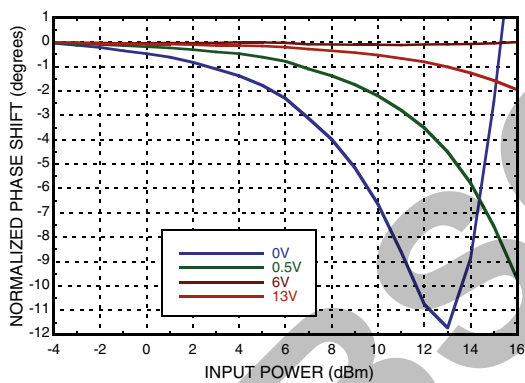

Input Return Loss vs. Frequency, Vctl = 0 to +13V

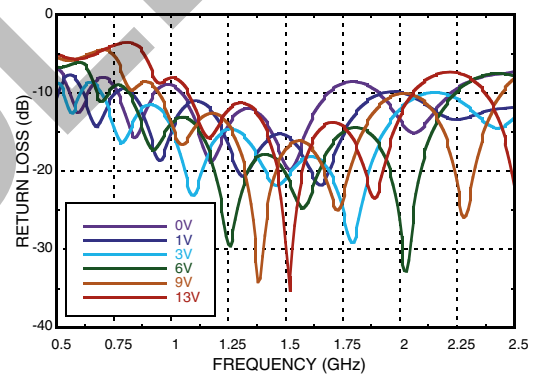

Output Return Loss vs. Frequency, Vctl = 0 to +13V

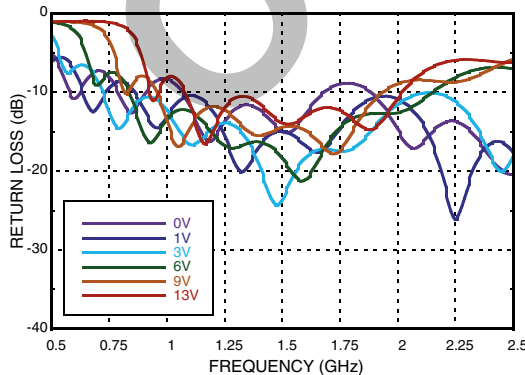

Absolute Maximum Ratings

Frequency Control Voltage (Vctl)	-0.5 to +15V
RF Input Power	27 dBm
Storage Temperature	-65 to +150 °C
ESD Sensitivity (HBM)	Class 1B

Reliability Information

Junction Temperature To Maintain 1 Million Hour MTTF	150 °C
Nominal Junction Temperature (T = 85 °C and Pin = 10 dBm)	87 °C
Thermal Resistance (Junction To Ground Paddle)	45 °C/W
Operating Temperature	-40 to +85 °C



**ELECTROSTATIC SENSITIVE DEVICE
OBSERVE HANDLING PRECAUTIONS**

Information furnished by Analog Devices is believed to be accurate and reliable. However, no responsibility is assumed by Analog Devices for its use, nor for any infringements of patents or other rights of third parties that may result from its use. Specifications subject to change without notice. No license is granted by implication or otherwise under any patent or patent rights of Analog Devices. Trademarks and registered trademarks are the property of their respective owners.

For price, delivery, and to place orders: Analog Devices, Inc., One Technology Way, P.O. Box 9106, Norwood, MA 02062-9106 Phone: 781-329-4700 • Order online at www.analog.com Application Support: Phone: 1-800-ANALOG-D



**400° ANALOG PHASE SHIFTER
1 - 2 GHz**

Outline Drawing

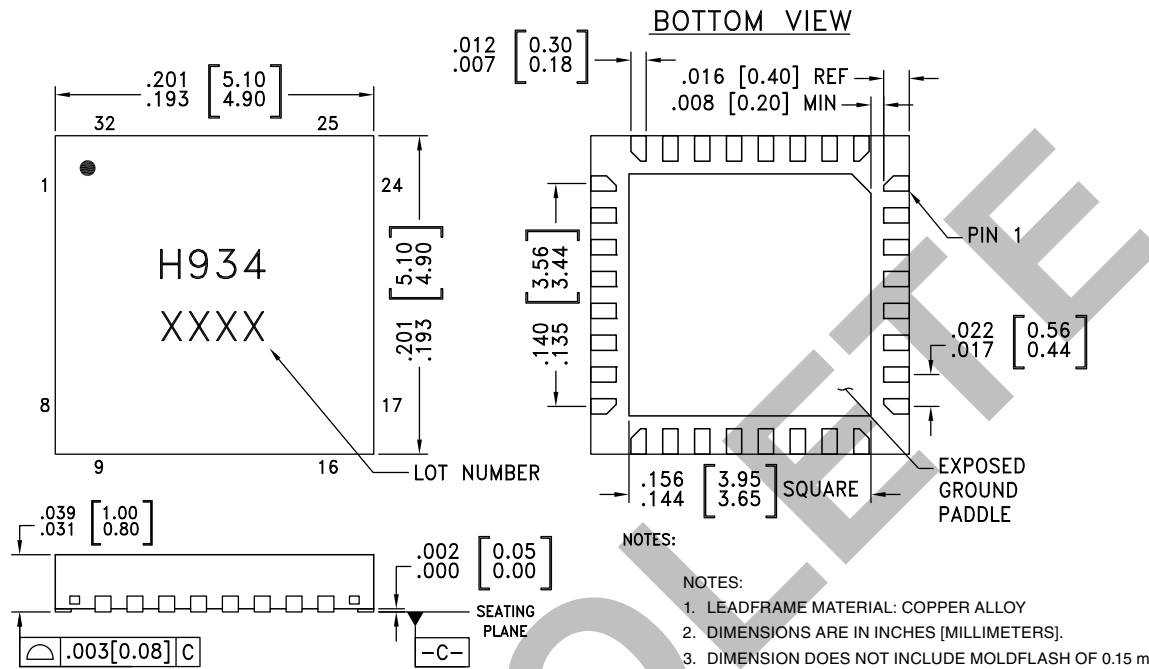

NOTES:

- 1. LEADFRAME MATERIAL: COPPER ALLOY
- 2. DIMENSIONS ARE IN INCHES [MILLIMETERS].
- 3. DIMENSION DOES NOT INCLUDE MOLDFLASH OF 0.15 mm PER SIDE.
- 4. DIMENSION DOES NOT INCLUDE MOLDFLASH OF 0.25 mm PER SIDE.
- 5. ALL GROUND LEADS MUST BE SOLDERED TO PCB RF GROUND.
- 6. CLASSIFIED AS MOISTURE SENSITIVITY LEVEL (MSL) 1.

Package Information

Part Number	Package Body Material	Lead Finish	MSL Rating	Package Marking ^[1]
HMC934LP5E	RoHS-Compliant Low Stress Injection Molded Plastic	100% Matte Sn	MSL1 ^[2]	H934 XXXX

[1] 4-Digit lot number XXXX
[2] Max peak reflow temperature of 260 °C

Pin Descriptions

Pin Number	Function	Description	Interface Schematic
1 - 5, 8 - 13, 15 - 17, 20 - 32	N/C	No connection required. These pins may be connected to RF/DC ground without affecting performance.	
7, 18	GND	Ground: Backside of package has exposed metal ground paddle that must be connected to ground thru a short path. Vias under the device are required.	
6	RFIN	This pin is AC coupled and matched to 50 Ohms.	
19	RFOUT	This pin is AC coupled and matched to 50 Ohms.	
14	Vctl	Phase shift control pin. Application of a voltage between 0 and 13 volts causes the transmission phase to change. The DC equivalent circuit is a series connected diode and resistor.	

Information furnished by Analog Devices is believed to be accurate and reliable. However, no responsibility is assumed by Analog Devices for its use, nor for any infringements of patents or other rights of third parties that may result from its use. Specifications subject to change without notice. No license is granted by implication or otherwise under any patent or patent rights of Analog Devices. Trademarks and registered trademarks are the property of their respective owners.

For price, delivery, and to place orders: Analog Devices, Inc., One Technology Way, P.O. Box 9106, Norwood, MA 02062-9106
Phone: 781-329-4700 • Order online at www.analog.com
Application Support: Phone: 1-800-ANALOG-D



Evaluation PCB

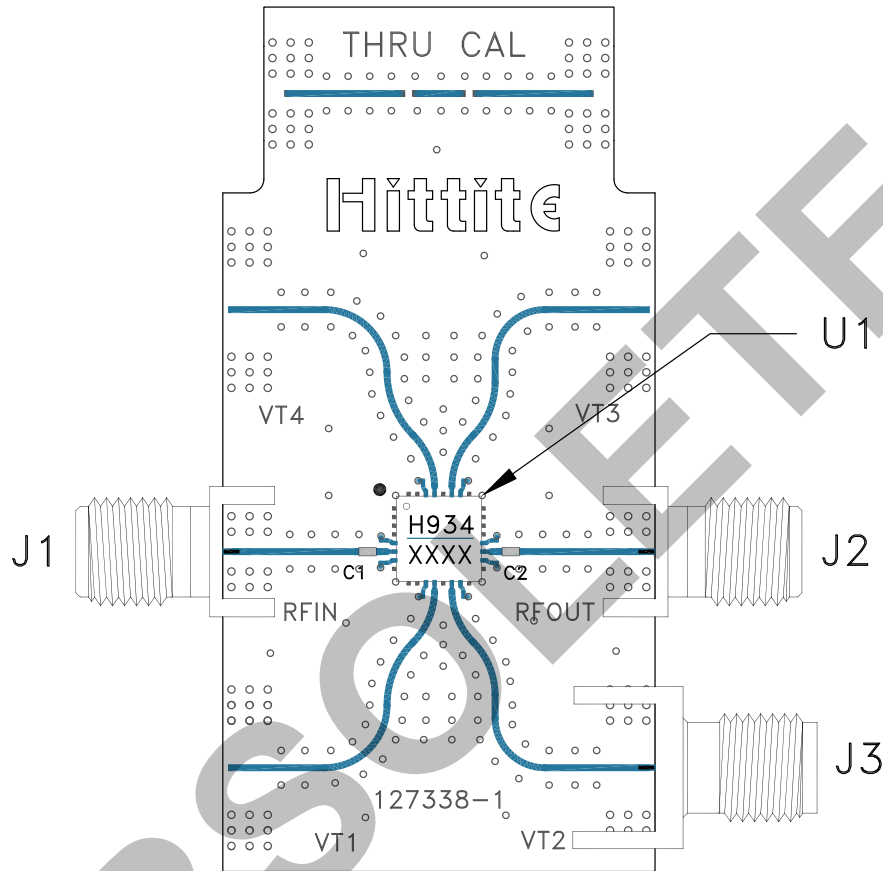

List of Materials for Evaluation PCB 131046 [1]

Item	Description
J1, J2	Connector, SMA, Jack
J3	Connector, SMA, Jack
U1	HMC934LP5E Analog Phase Shifter
C1, C2	Capacitor, 100 pF, 0402 Pkg.
PCB	127338, Evaluation PCB

[1] Reference this number when ordering complete evaluation PCB

[2] Circuit Board Material: Rogers 4350 or Arlon 25 FR

The circuit board used in the application should use RF circuit design techniques. Signal lines should have 50 Ohm impedance while the package ground leads and exposed paddle should be connected directly to the ground plane similar to that shown. A sufficient number of via holes should be used to connect the top and bottom ground planes. The evaluation board should be mounted to an appropriate heat sink. The evaluation circuit board shown is available from Hittite upon request.