

General Description

The AOZ8831-03 is an ultra low capacitance one-line bi-directional transient voltage suppressor diode designed to protect high speed data lines and voltage sensitive electronics from high transient conditions and ESD.

This device incorporates one TVS diode in an ultra-small DFN 1.0 x 0.6 package. It may be used to meet the ESD immunity requirements of IEC 61000-4-2, Level 4.

The AOZ8831-03 comes in an RoHS compliant DFN package and is rated over a -40°C to +85°C ambient temperature range.

The ultra-small 1.0 x 0.6 x 0.4mm DFN package makes it ideal for applications where PCB space is a premium. The small size and high ESD protection makes it ideal for protecting voltage sensitive electronics from high transient conditions and ESD.

Features

- ESD protection for high-speed data lines:
 - Exceeds: IEC 61000-4-2 (ESD) $\pm 20\text{kV}$ (air), $\pm 20\text{kV}$ (contact)
 - Human Body Model (HBM) $\pm 15\text{kV}$
- Small package saves board space
- Ultra low capacitance: 0.22pF
- Low clamping voltage
- Operating voltage: 3.6V
- Pb-free device

Applications

- Portable handheld devices
- Notebook computers
- Digital Cameras
- Portable GPS



Typical Application

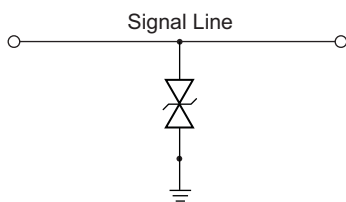

Bidirection Protection of Single Line

Pin Configuration

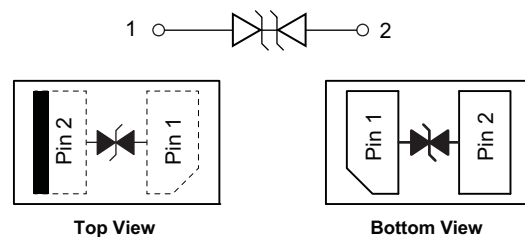

Ordering Information

Part Number	Ambient Temperature Range	Package	Environmental
AOZ8831DT-03	-40°C to +85°C	DFN 1.0 x 0.6	Green Product



AOS Green Products use reduced levels of Halogens, and are also RoHS compliant. Please visit www.aosmd.com/media/AOSGreenPolicy.pdf for additional information.

Absolute Maximum Ratings

Exceeding the Absolute Maximum ratings may damage the device.

Parameter	Rating
VP – VN	3.6V
Peak Pulse Current (I_{PP}), $t_P = 8/20\mu s$	6A
Peak Pulse Power (IEC61000-4-5 8/20 μs current pulse)	90W
Storage Temperature (T_S)	-65°C to +150°C
ESD Rating per IEC61000-4-2, Contact ⁽¹⁾	±20kV
ESD Rating per IEC61000-4-2, Air ⁽¹⁾	±20kV
ESD Rating per Human Body Model ⁽²⁾	±15kV

Notes:

- IEC 61000-4-2 discharge with $C_{Discharge} = 150pF$, $R_{Discharge} = 330\Omega$.
- Human Body Discharge per MIL-STD-883, Method 3015 $C_{Discharge} = 100pF$, $R_{Discharge} = 1.5k\Omega$.

Maximum Operating Ratings

Parameter	Rating
Junction Temperature (T_J)	-40°C to +125°C

Electrical Characteristics

T_A = 25°C unless otherwise specified.

Symbol	Parameter	Diagram
I _{PP}	Maximum Reverse Peak Pulse Current ⁽³⁾ (IEC61000-4-5 8/20μs pulse)	
V _{CL}	Clamping Voltage @ I _{PP} ⁽³⁾	
V _{RWM}	Working Peak Reverse Voltage	
I _R	Maximum Reverse Leakage Current	
V _{BR}	Breakdown Voltage	
C _J	Capacitance @ V _R = 0 and f = 1MHz	

Device	Device Marking	V _{RWM} (V) Max.	V _{BR} (V)		I _R (μA) Max.	V _{CL} Max.			C _J (pF)	
			Min.	Max.		I _{PP} = 1 A	I _{PP} = 4 A	I _{PP} = 6 A	Typ.	Max.
AOZ8831DT-03	4	3.6	4.5	10	0.1	4	9.5	15	0.22	0.35

Notes:

3. These specifications are guaranteed by design and characterization.

Performance Characteristics

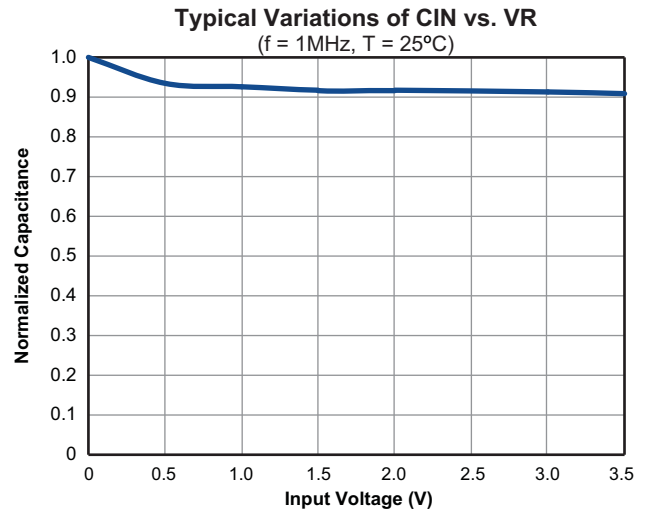
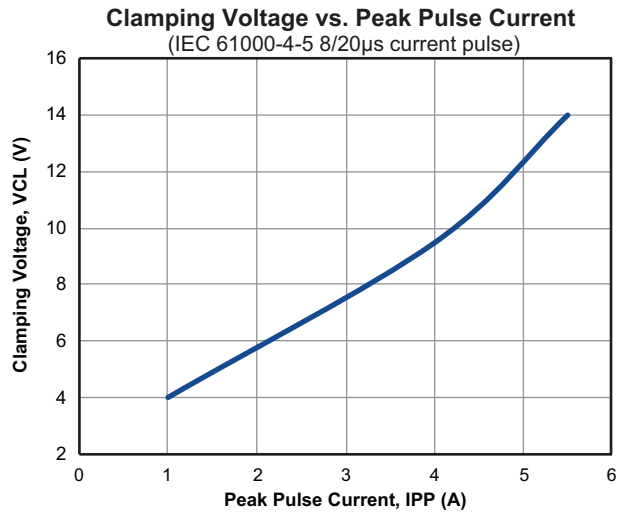

Package Dimensions, DFN 1.0 x 0.6

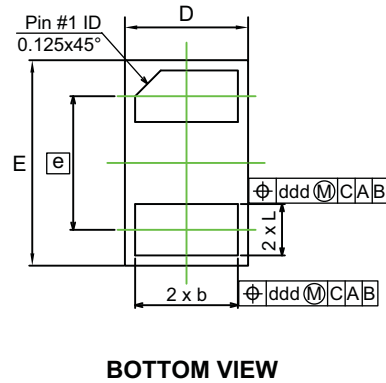
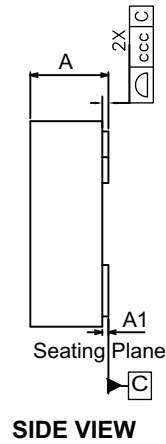

RECOMMENDED LAND PATTERN

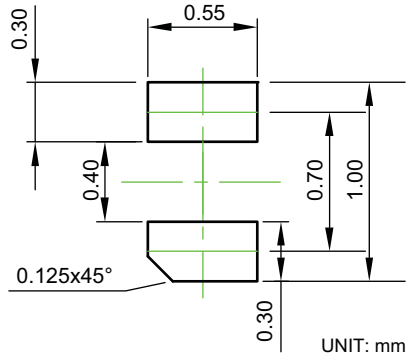

Dimensions in millimeters

Symbols	Min.	Nom.	Max.
A	0.31	0.38	0.40
A1	0.00	0.02	0.05
b	0.45	0.50	0.55
D	0.55	0.60	0.65
E	0.95	1.00	1.05
e	0.65 BSC		
L	0.20	0.25	0.30
ccc	0.03		
ddd	0.10		

Dimensions in inches

Symbols	Min.	Nom.	Max.
A	0.012	0.015	0.016
A1	0.000	0.001	0.002
b	0.018	0.020	0.022
D	0.022	0.024	0.026
E	0.037	0.039	0.041
e	0.026 BSC		
L	0.008	0.010	0.012
ccc	0.001		
ddd	0.004		

Notes:

1. All dimensions are in millimeters, angles are in degrees.
2. Coplanarity applies to the exposed heat sink slug as well as the terminals.

Tape and Reel Dimensions, DFN 1.0 x 0.6

Carrier Tape

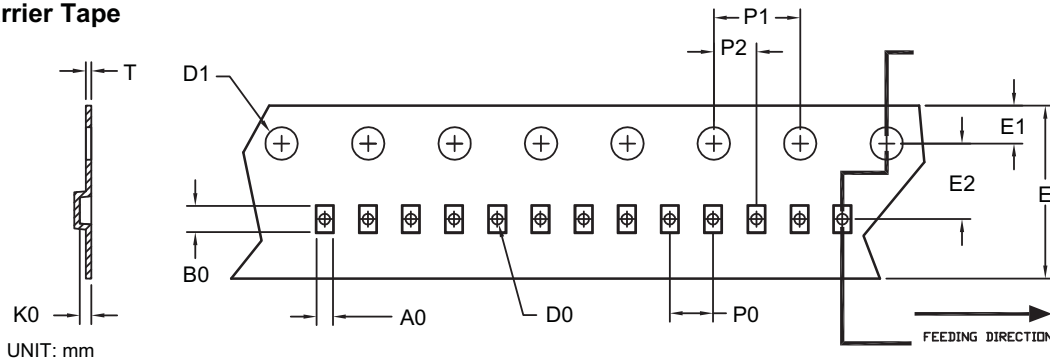

UNIT: mm

Option	Package	A0	B0	K0	D0	D1	E	E1	E2	P0	P1	P2	T
A	DFN 1.0x0.6/ DFN 1.0x0.6A (8 mm)	0.69 ±0.05	1.19 ±0.05	0.66 ±0.05	0.40 ±0.05	1.50 ±0.10	8.00 +0.3/-0.1	1.75 ±0.10	3.50 ±0.05	2.00 ±0.05	4.00 ±0.10	2.00 ±0.05	0.23 ±0.02
B	DFN 1.0x0.6/ DFN 1.0x0.6A (8 mm)	0.65 ±0.04	1.05 ±0.04	0.61 ±0.04	0.40 ±0.05	1.50 ±0.10	8.00 +0.3/-0.1	1.75 ±0.10	3.50 ±0.05	2.00 ±0.10	4.00 ±0.10	2.00 ±0.05	0.20 ±0.05

Reel

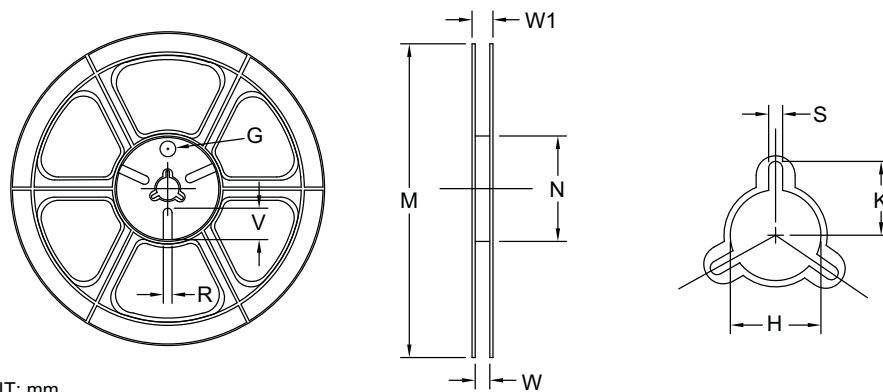

UNIT: mm

Tape Size	Reel Size	M	N	W	W1	H	K	S	G	R	V
8mm	ø178	ø178 ±0.5	ø55 ±1	8.4 +1.5/-0	Max. 14.4	ø13.0 ±0.5	Max. 10.1	2.0 ±0.5	N/A	N/A	N/A

Leader/Trailer & Orientation

TVS
Unit Per Reel:
10000pcs

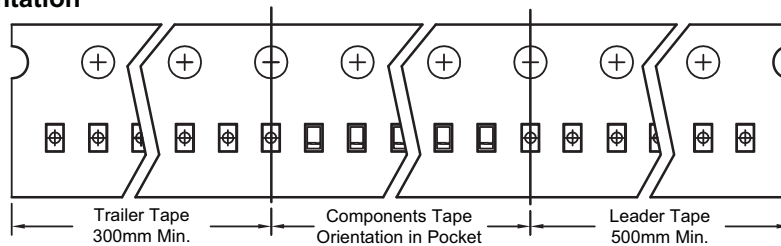

MOS
Unit Per Reel:
10000pcs

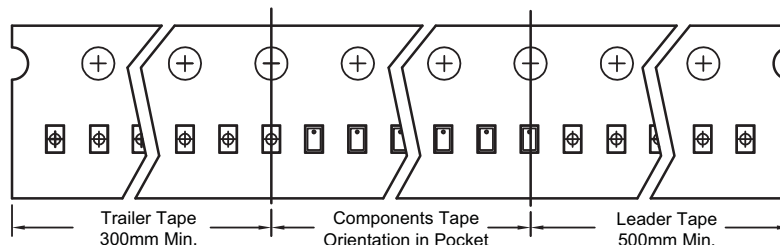

Part Marking

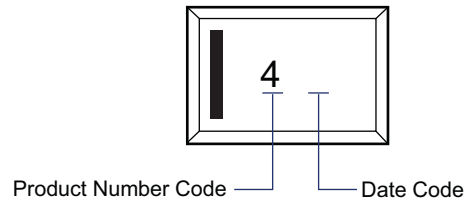

LEGAL DISCLAIMER

Alpha and Omega Semiconductor makes no representations or warranties with respect to the accuracy or completeness of the information provided herein and takes no liabilities for the consequences of use of such information or any product described herein. Alpha and Omega Semiconductor reserves the right to make changes to such information at any time without further notice. This document does not constitute the grant of any intellectual property rights or representation of non-infringement of any third party's intellectual property rights.

LIFE SUPPORT POLICY

ALPHA AND OMEGA SEMICONDUCTOR PRODUCTS ARE NOT AUTHORIZED FOR USE AS CRITICAL COMPONENTS IN LIFE SUPPORT DEVICES OR SYSTEMS.

As used herein:

1. Life support devices or systems are devices or systems which, (a) are intended for surgical implant into the body or (b) support or sustain life, and (c) whose failure to perform when properly used in accordance with instructions for use provided in the labeling, can be reasonably expected to result in a significant injury of the user.
2. A critical component in any component of a life support, device, or system whose failure to perform can be reasonably expected to cause the failure of the life support device or system, or to affect its safety or effectiveness.