

Trench gate field-stop IGBT, H series 1200 V, 40 A high speed

Datasheet - production data

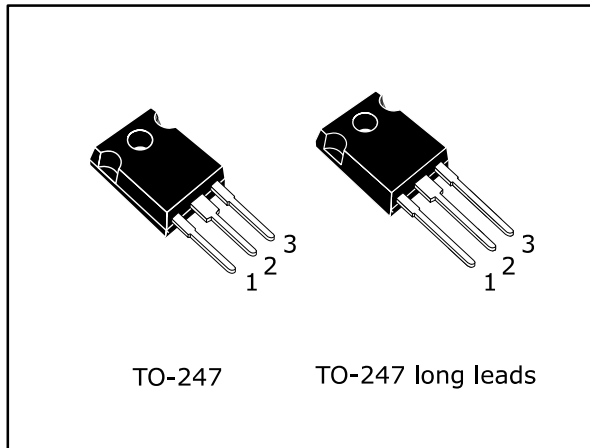
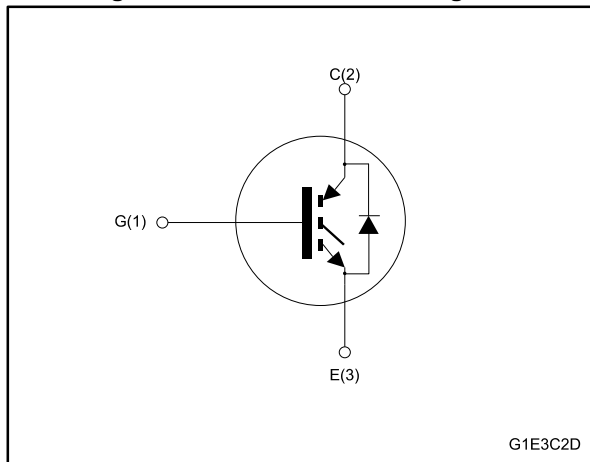

Figure 1: Internal schematic diagram



Features

- Maximum junction temperature: $T_J = 175\text{ }^\circ\text{C}$
- High speed switching series
- Minimized tail current
- $V_{CE(sat)} = 2.1\text{ V (typ.) @ } I_C = 40\text{ A}$
- $5\text{ }\mu\text{s}$ minimum short circuit withstand time at $T_J=150\text{ }^\circ\text{C}$
- Safe paralleling
- Very fast recovery antiparallel diode
- Low thermal resistance

Applications

- Uninterruptible power supply
- Welding machines
- Photovoltaic inverters
- Power factor correction
- High frequency converters

Description

These devices are IGBTs developed using an advanced proprietary trench gate field-stop structure. These devices are part of the H series of IGBTs, which represents an optimum compromise between conduction and switching losses to maximize the efficiency of high switching frequency converters. Furthermore, a slightly positive $V_{CE(sat)}$ temperature coefficient and very tight parameter distribution result in safer paralleling operation.

Table 1: Device summary

Order code	Marking	Package	Packaging
STGW40H120DF2	G40H120DF2	TO-247	Tube
STGWA40H120DF2	G40H120DF2	TO-247 long leads	Tube

Contents

1	Electrical ratings	3
2	Electrical characteristics	4
	2.1 Electrical characteristics (curves)	6
3	Test circuits	11
4	Package information	12
	4.1 TO-247 package information	12
	4.2 TO-247 long leads package information	14
5	Revision history	16

1 Electrical ratings

Table 2: Absolute maximum ratings

Symbol	Parameter	Value	Unit
V_{CES}	Collector-emitter voltage ($V_{GE} = 0$)	1200	V
I_C	Continuous collector current at $T_C = 25\text{ °C}$	80	A
I_C	Continuous collector current at $T_C = 100\text{ °C}$	40	A
$I_{CP}^{(1)}$	Pulsed collector current	160	A
V_{GE}	Gate-emitter voltage	± 20	V
V_{GE}	Transient gate-emitter voltage ($t_p \leq 10\ \mu\text{s}$, $D \leq 0.01$)	± 30	V
I_F	Continuous forward current at $T_C = 25\text{ °C}$	80	A
I_F	Continuous forward current at $T_C = 100\text{ °C}$	40	A
$I_{FP}^{(1)}$	Pulsed forward current	160	A
P_{TOT}	Total dissipation at $T_C = 25\text{ °C}$	468	W
T_{STG}	Storage temperature range	-55 to 150	$^{\circ}\text{C}$
T_J	Operating junction temperature range	-55 to 175	$^{\circ}\text{C}$

Notes:

⁽¹⁾Pulse width limited by maximum junction temperature.

Table 3: Thermal data

Symbol	Parameter	Value	Unit
R_{thJC}	Thermal resistance junction-case IGBT	0.32	$^{\circ}\text{C/W}$
R_{thJC}	Thermal resistance junction-case diode	1.3	$^{\circ}\text{C/W}$
R_{thJA}	Thermal resistance junction-ambient	50	$^{\circ}\text{C/W}$

2 Electrical characteristics

$T_C = 25\text{ °C}$ unless otherwise specified

Table 4: Static characteristics

Symbol	Parameter	Test conditions	Min.	Typ.	Max.	Unit
$V_{(BR)CES}$	Collector-emitter breakdown voltage	$V_{GE} = 0\text{ V}$, $I_C = 2\text{ mA}$	1200			V
$V_{CE(sat)}$	Collector-emitter saturation voltage	$V_{GE} = 15\text{ V}$, $I_C = 40\text{ A}$		2.1	2.6	V
		$V_{GE} = 15\text{ V}$, $I_C = 40\text{ A}$, $T_J = 125\text{ °C}$		2.4		
		$V_{GE} = 15\text{ V}$, $I_C = 40\text{ A}$, $T_J = 175\text{ °C}$		2.5		
V_F	Forward on-voltage	$I_F = 40\text{ A}$		3.9	4.9	V
		$I_F = 40\text{ A}$, $T_J = 125\text{ °C}$		3.05		
		$I_F = 40\text{ A}$, $T_J = 175\text{ °C}$		2.8		
$V_{GE(th)}$	Gate threshold voltage	$V_{CE} = V_{GE}$, $I_C = 2\text{ mA}$	5	6	7	V
I_{CES}	Collector cut-off current	$V_{GE} = 0\text{ V}$, $V_{CE} = 1200\text{ V}$			25	μA
I_{GES}	Gate-emitter leakage current	$V_{CE} = 0\text{ V}$, $V_{GE} = \pm 20\text{ V}$			± 250	nA

Table 5: Dynamic characteristics

Symbol	Parameter	Test conditions	Min.	Typ.	Max.	Unit
C_{ies}	Input capacitance	$V_{CE} = 25\text{ V}$, $f = 1\text{ MHz}$, $V_{GE} = 0\text{ V}$	-	3200	-	pF
C_{oes}	Output capacitance		-	220	-	
C_{res}	Reverse transfer capacitance		-	80	-	
Q_g	Total gate charge	$V_{CC} = 960\text{ V}$, $I_C = 40\text{ A}$, $V_{GE} = 15\text{ V}$ (see Figure 30: "Gate charge test circuit")	-	158	-	nC
Q_{ge}	Gate-emitter charge		-	17	-	
Q_{gc}	Gate-collector charge		-	85	-	

Table 6: IGBT switching characteristics (inductive load)

Symbol	Parameter	Test conditions	Min.	Typ.	Max.	Unit
$t_{d(on)}$	Turn-on delay time	$V_{CE} = 600\text{ V}$, $I_C = 40\text{ A}$, $V_{GE} = 15\text{ V}$, $R_G = 10\ \Omega$ (see Figure 31: "Switching waveform")		18	-	ns
t_r	Current rise time			37	-	ns
$(di/dt)_{on}$	Turn-on current slope			1755	-	A/ μ s
$t_{d(off)}$	Turn-off-delay time			152	-	ns
t_f	Current fall time			83	-	ns
$E_{on}^{(1)}$	Turn-on switching energy			1	-	mJ
$E_{off}^{(2)}$	Turn-off switching energy			1.32	-	mJ
E_{ts}	Total switching energy		2.32	-	mJ	
$t_{d(on)}$	Turn-on delay time	$V_{CE} = 600\text{ V}$, $I_C = 40\text{ A}$, $V_{GE} = 15\text{ V}$, $R_G = 10\ \Omega$ $T_J = 175\text{ }^\circ\text{C}$ (see Figure 31: "Switching waveform")		36	-	ns
t_r	Current rise time			20	-	ns
$(di/dt)_{on}$	Turn-on current slope			1580	-	A/ μ s
$t_{d(off)}$	Turn-off-delay time			161	-	ns
t_f	Current fall time			190	-	ns
$E_{on}^{(1)}$	Turn-on switching energy			1.81	-	mJ
$E_{off}^{(2)}$	Turn-off switching energy			2.46	-	mJ
E_{ts}	Total switching energy		4.27	-	mJ	
t_{sc}	Short-circuit withstand time	$V_{CC} = 600\text{ V}$, $V_{GE} = 15\text{ V}$, $T_{Jstart} = 150\text{ }^\circ\text{C}$	5		-	μ s

Notes:⁽¹⁾Including the reverse recovery of the diode.⁽²⁾Including the tail of the collector current.

Table 7: Diode switching characteristics (inductive load)

Symbol	Parameter	Test conditions	Min.	Typ.	Max.	Unit
t_{rr}	Reverse recovery time	$I_F = 40\text{ A}$, $V_R = 600\text{ V}$, $V_{GE} = 15\text{ V}$ (see Figure 31: "Switching waveform") $di/dt = 500\text{ A}/\mu\text{s}$	-	488		ns
Q_{rr}	Reverse recovery charge		-	2.59		μC
I_{rrm}	Reverse recovery current		-	11.6		A
dl_{rr}/dt	Peak rate of fall of reverse recovery current during t_b		-	406		A/ μ s
E_{rr}	Reverse recovery energy		-	0.38		mJ
t_{rr}	Reverse recovery time	$I_F = 40\text{ A}$, $V_R = 600\text{ V}$, $V_{GE} = 15\text{ V}$ $T_J = 175\text{ }^\circ\text{C}$ (see Figure 31: "Switching waveform") $di/dt = 500\text{ A}/\mu\text{s}$	-	484		ns
Q_{rr}	Reverse recovery charge		-	4.5		μC
I_{rrm}	Reverse recovery current		-	18.6		A
dl_{rr}/dt	Peak rate of fall of reverse recovery current during t_b		-	170		A/ μ s
E_{rr}	Reverse recovery energy		-	0.94		mJ

2.2 Electrical characteristics (curves)

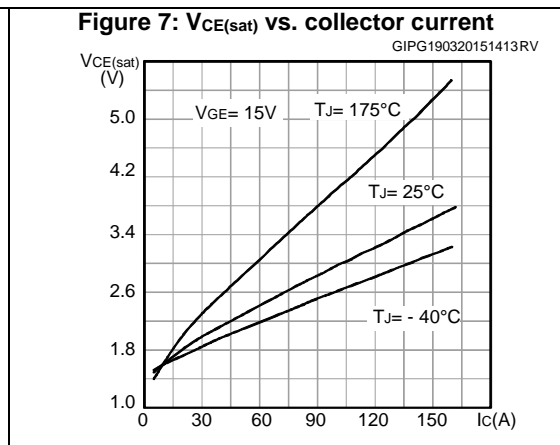
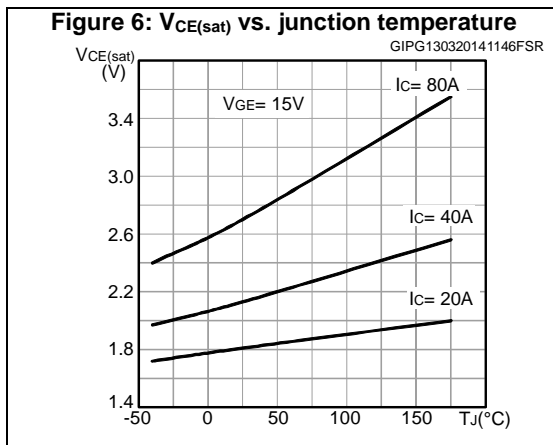
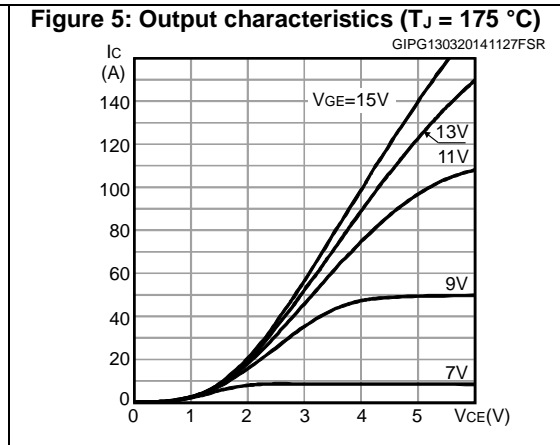
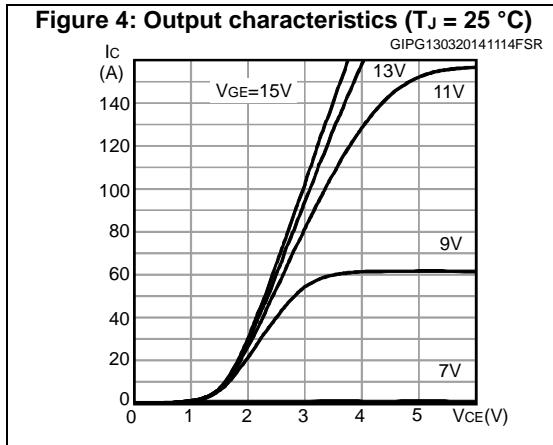
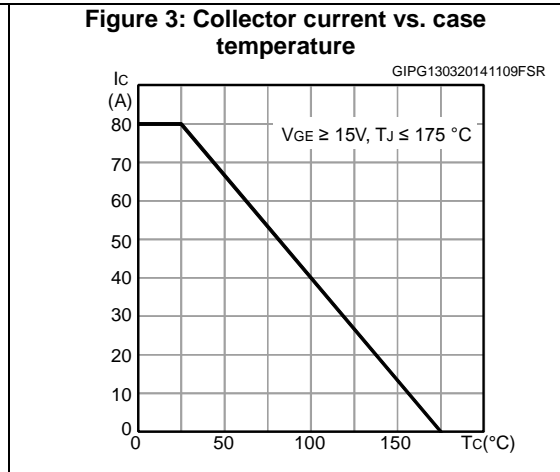
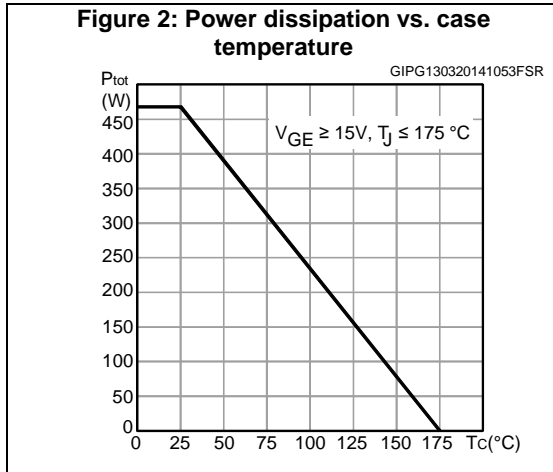

Figure 8: Collector current vs. switching frequency

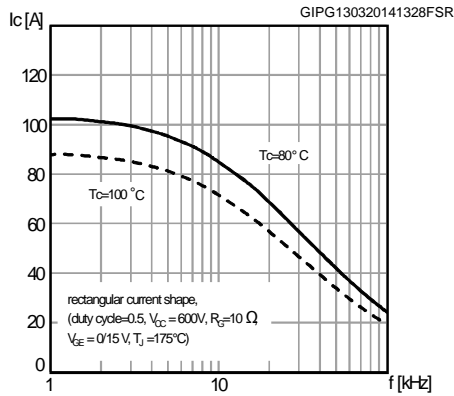

Figure 9: Forward bias safe operating area

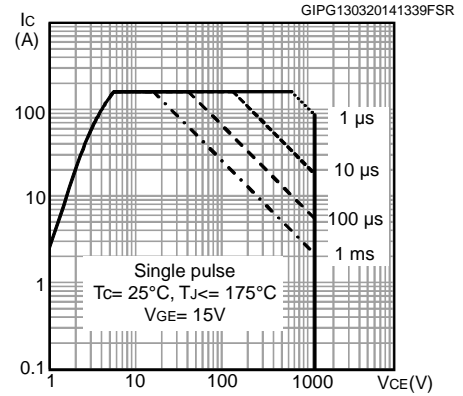

Figure 10: Transfer characteristics

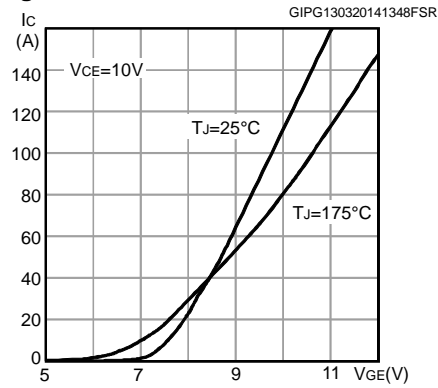

Figure 11: Diode V_F vs. forward current

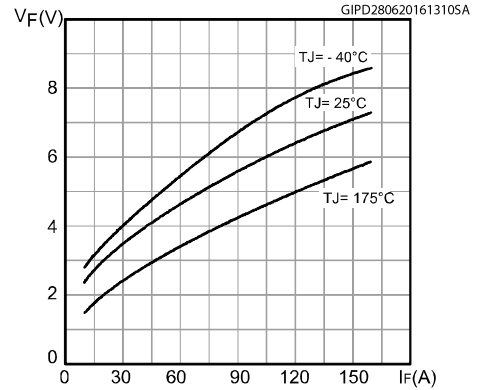

Figure 12: Normalized V_{GE(th)} vs. junction temperature

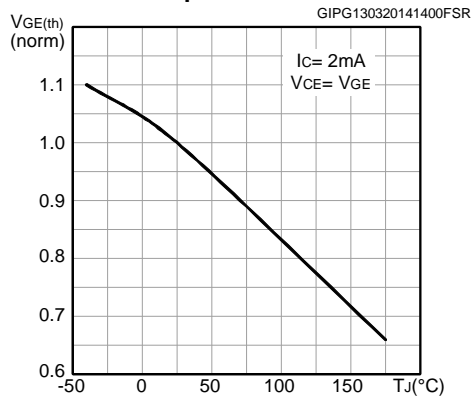

Figure 13: Normalized V_{(BR)CES} vs. junction temperature

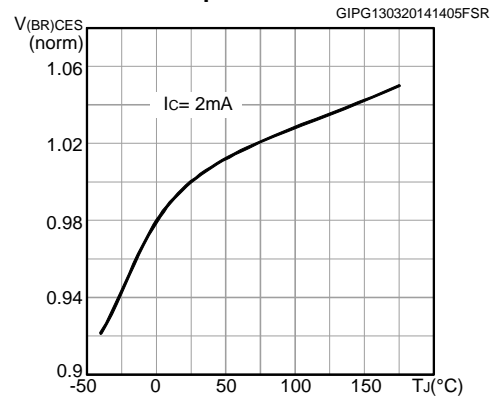

Figure 14: Capacitance variations

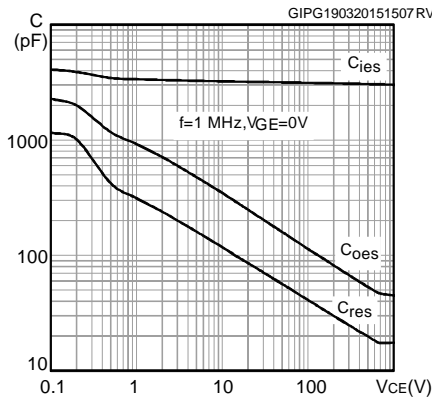

Figure 15: Gate charge vs. gate-emitter voltage

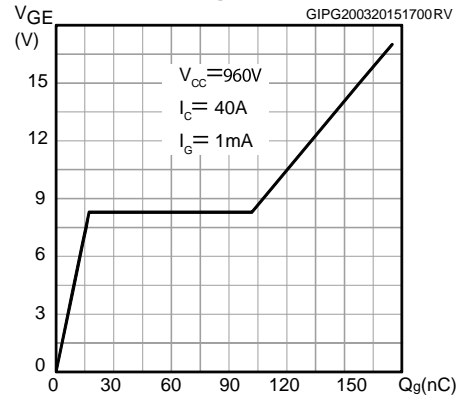

Figure 16: Switching energy vs. collector current

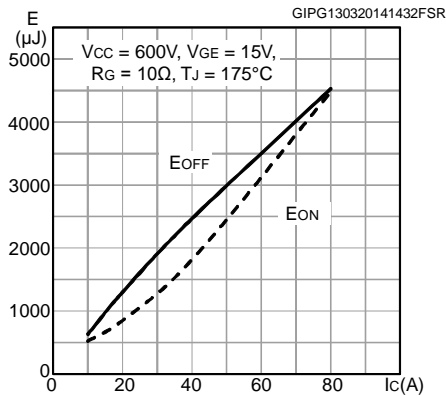

Figure 17: Switching energy vs. gate resistance

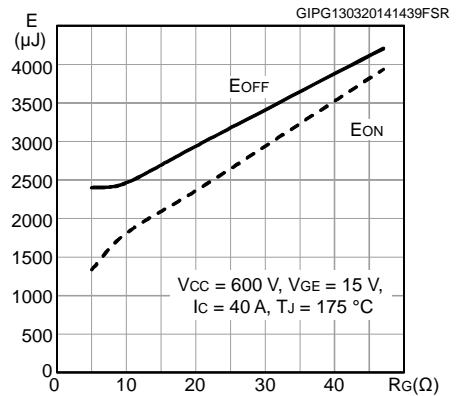

Figure 18: Switching energy vs. temperature

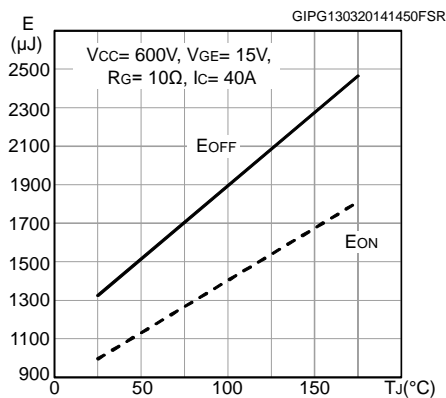

Figure 19: Switching energy vs. collector emitter voltage

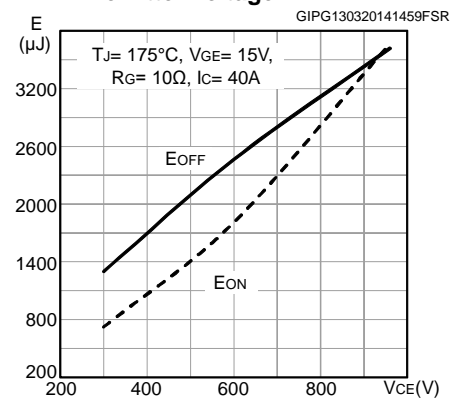

Figure 20: Short-circuit time and current vs. V_{GE}

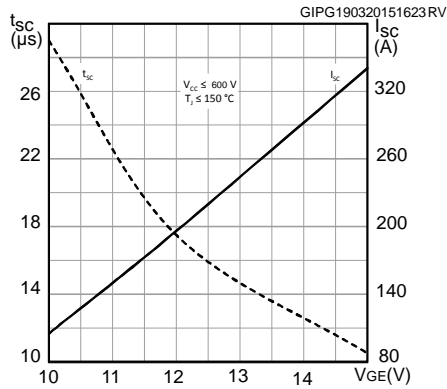

Figure 21: Switching times vs. collector current

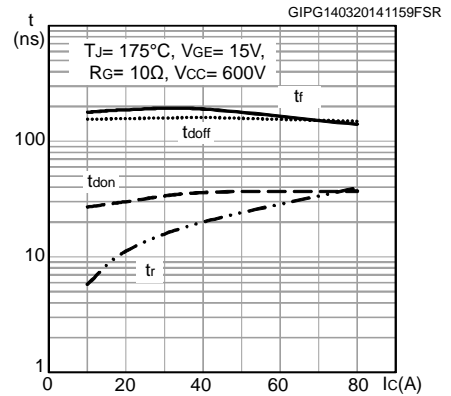

Figure 22: Switching times vs. gate resistance

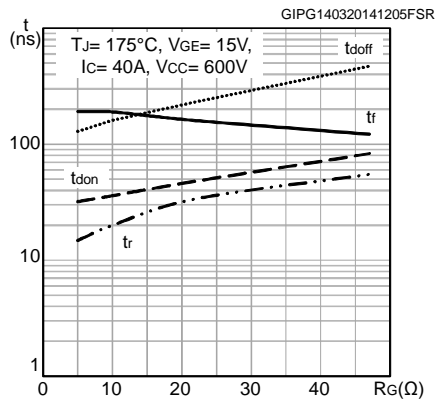

Figure 23: Reverse recovery current vs. diode current slope

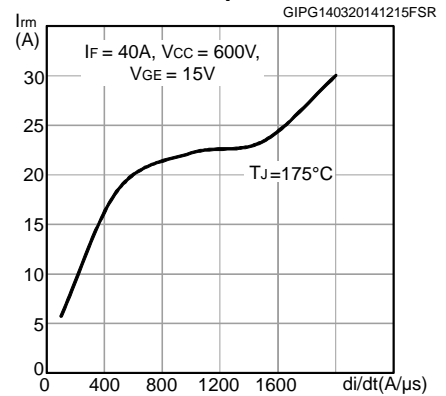

Figure 24: Reverse recovery time vs. diode current slope

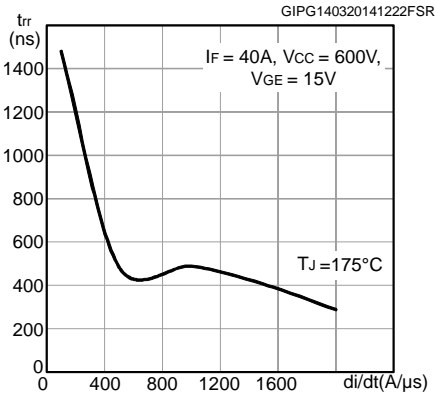

Figure 25: Reverse recovery charge vs. diode current slope

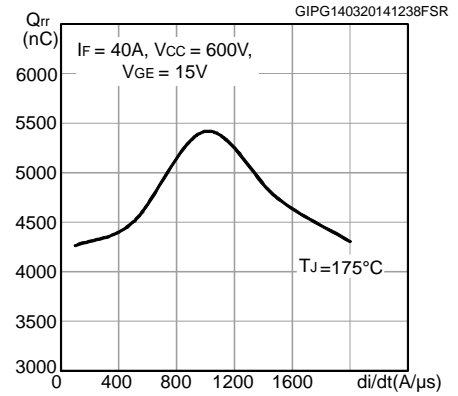

Figure 26: Reverse recovery energy vs. diode current slope

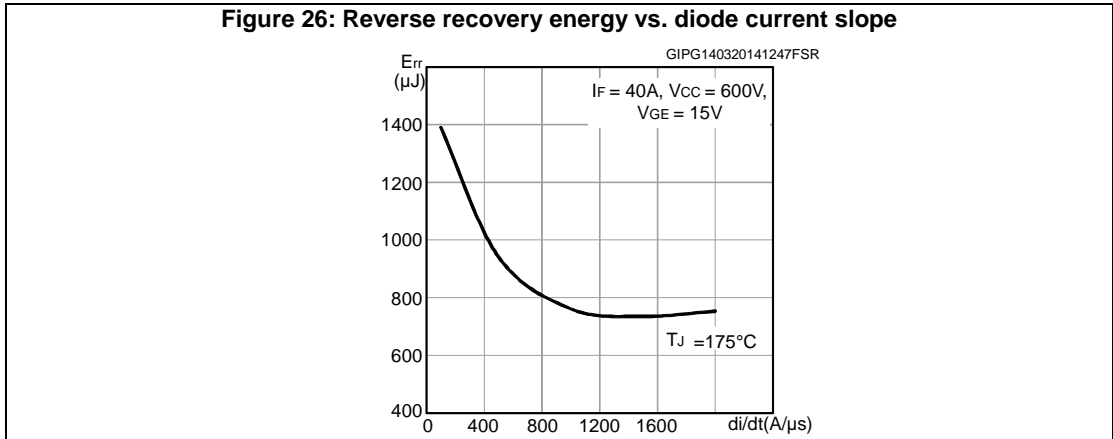

Figure 27: Thermal impedance for IGBT

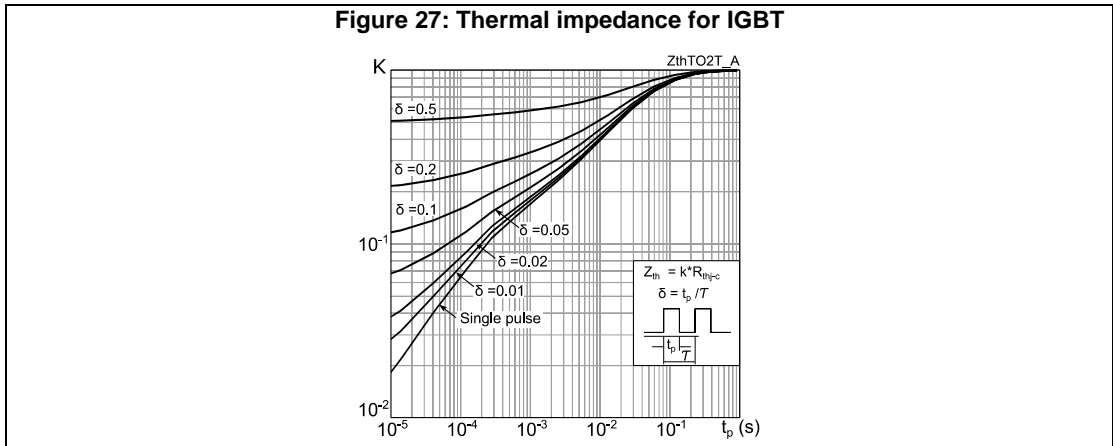
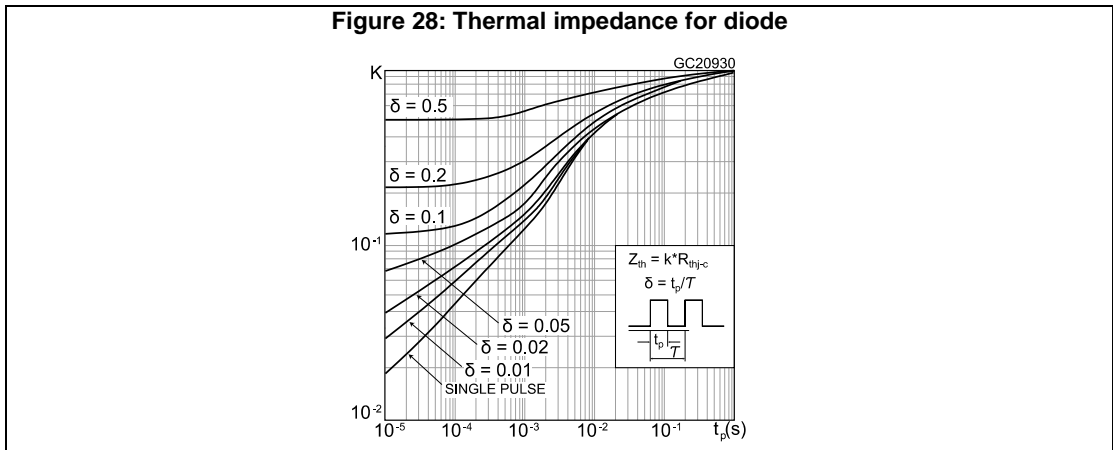
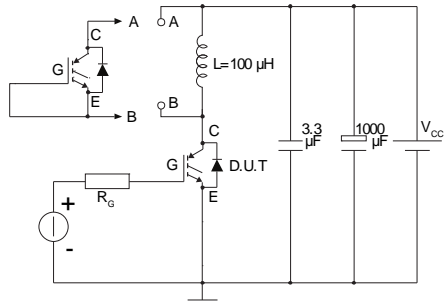

Figure 28: Thermal impedance for diode



3 Test circuits

Figure 29: Test circuit for inductive load switching



AM01504v1

Figure 30: Gate charge test circuit

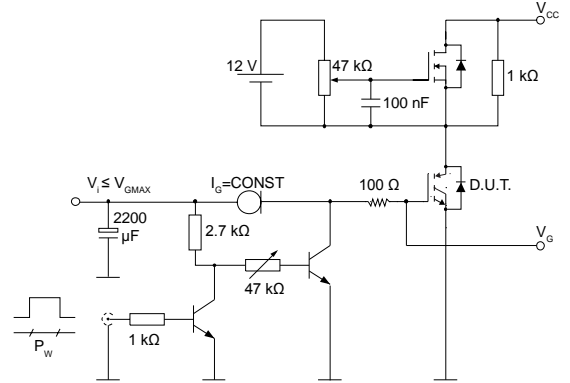

AM01505v1

Figure 31: Switching waveform

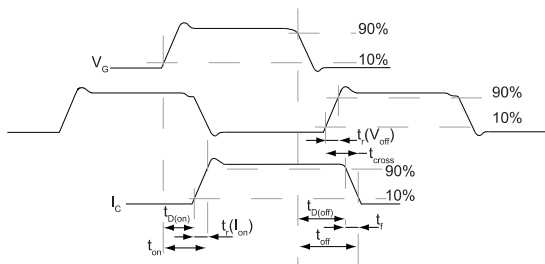

AM01506v1

Figure 32: Diode reverse recovery waveform

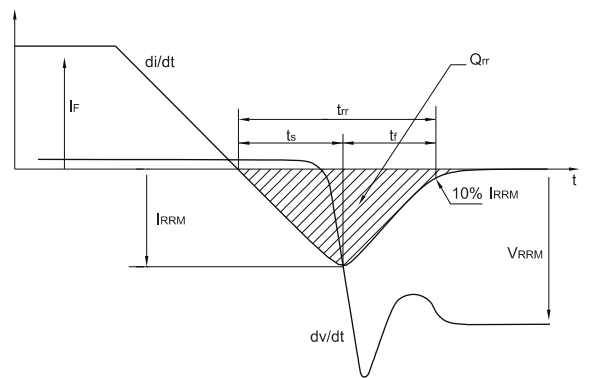

AM01507v1

4 Package information

In order to meet environmental requirements, ST offers these devices in different grades of ECOPACK® packages, depending on their level of environmental compliance. ECOPACK® specifications, grade definitions and product status are available at: www.st.com. ECOPACK® is an ST trademark.

4.1 TO-247 package information

Figure 33: TO-247 package outline

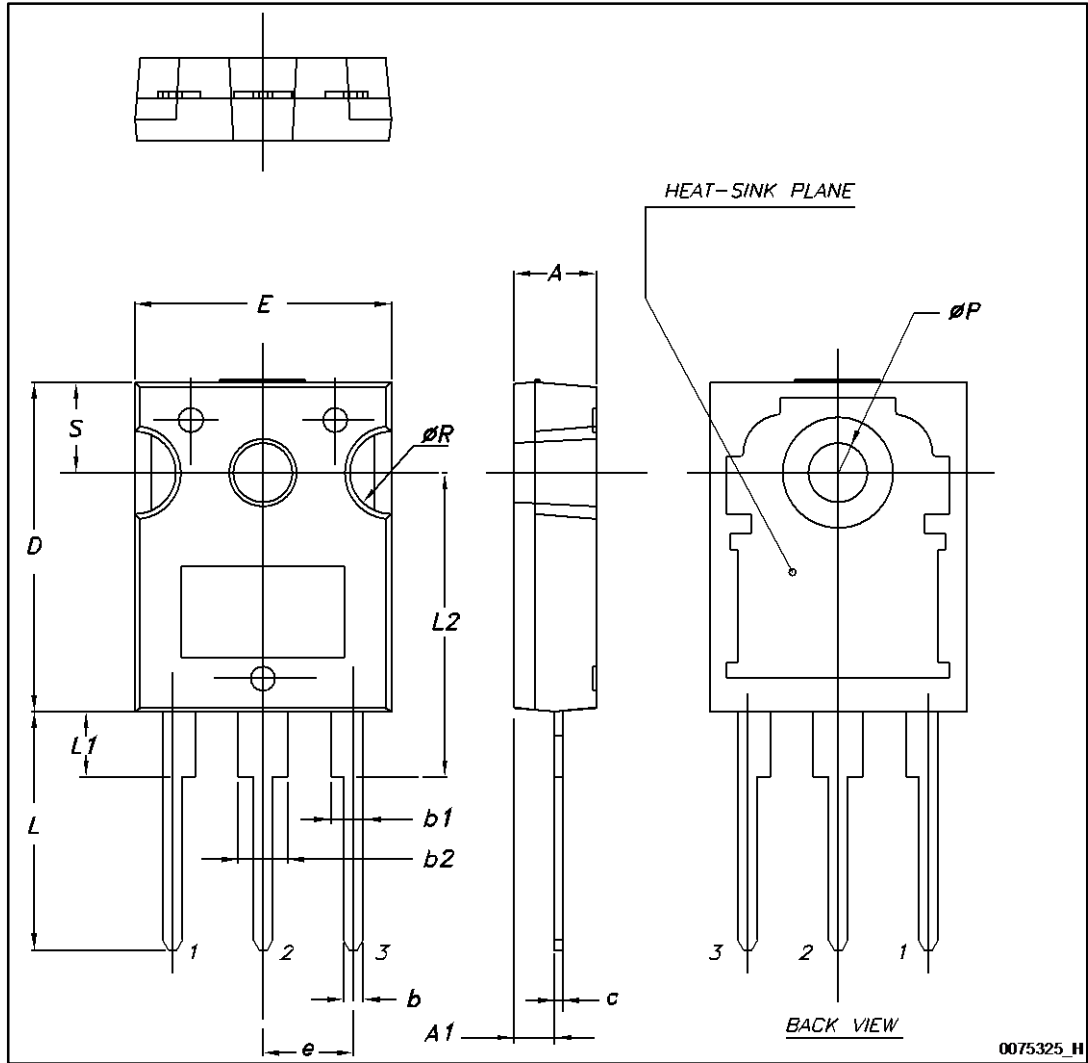

Table 8: TO-247 package mechanical data

Dim.	mm		
	Min.	Typ.	Max.
A	4.85		5.15
A1	2.20		2.60
b	1.0		1.40
b1	2.0		2.40
b2	3.0		3.40
c	0.40		0.80
D	19.85		20.15
E	15.45		15.75
e	5.30	5.45	5.60
L	14.20		14.80
L1	3.70		4.30
L2		18.50	
ØP	3.55		3.65
ØR	4.50		5.50
S	5.30	5.50	5.70

4.2 TO-247 long leads package information

Figure 34: TO-247 long lead package outline

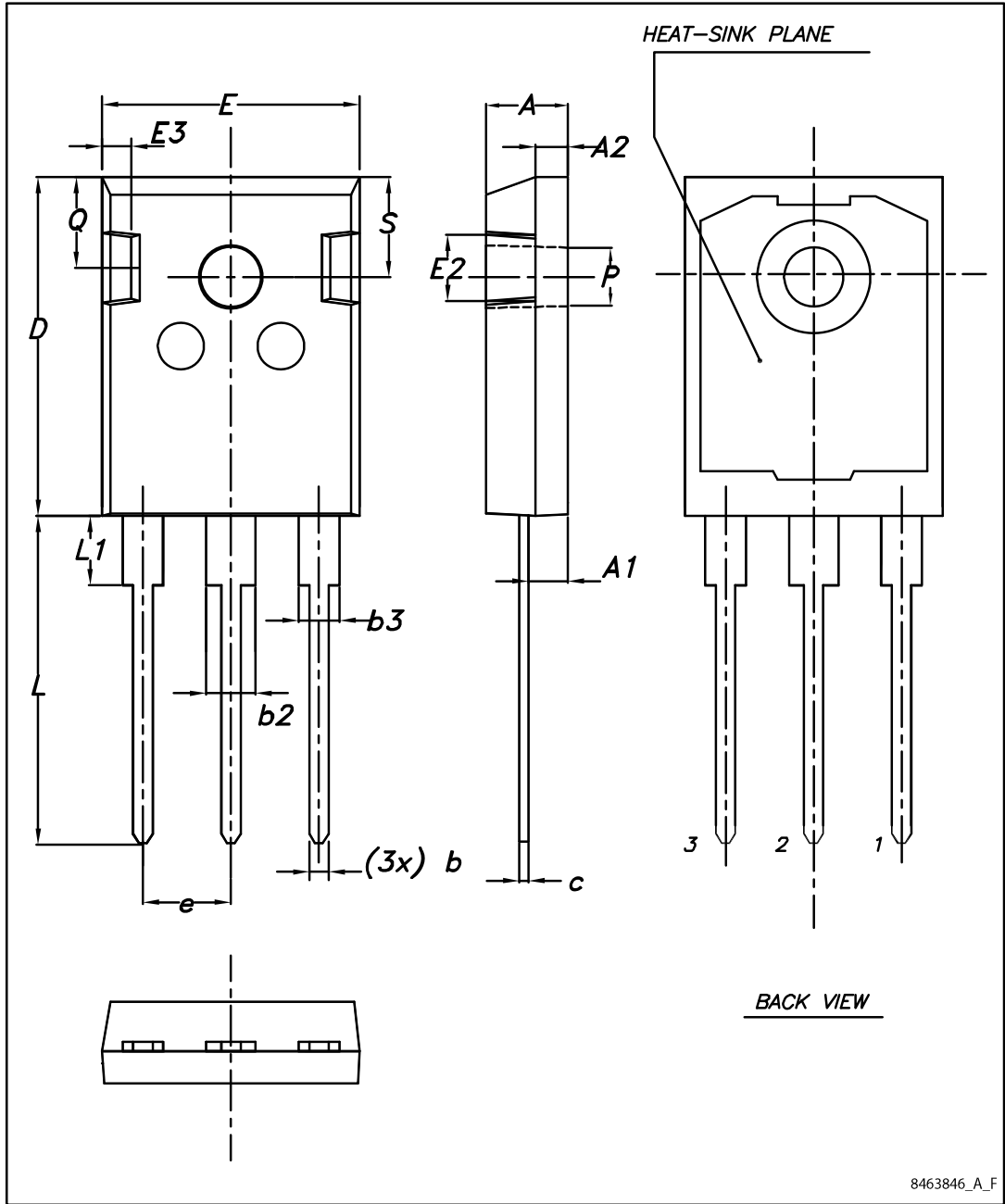

Table 9: TO-247 long lead package mechanical data

Dim.	mm		
	Min.	Typ.	Max.
A	4.90	5.00	5.10
A1	2.31	2.41	2.51
A2	1.90	2.00	2.10
b	1.16		1.26
b2			3.25
b3			2.25
c	0.59		0.66
D	20.90	21.00	21.10
E	15.70	15.80	15.90
E2	4.90	5.00	5.10
E3	2.40	2.50	2.60
e	5.34	5.44	5.54
L	19.80	19.92	20.10
L1			4.30
P	3.50	3.60	3.70
Q	5.60		6.00
S	6.05	6.15	6.25

5 Revision history

Table 10: Document revision history

Date	Revision	Changes
03-Oct-2012	1	First release.
29-Jan-2014	2	Updated features in cover page. Updated Table 4: Static characteristics, Table 5: Dynamic characteristics and Table 7: Diode switching characteristics (inductive load). Minor text changes.
24-Mar-2014	3	Updated title and description in cover page. Updated Table 4: Static characteristics, Table 5: Dynamic characteristics and Table 7: Diode switching characteristics (inductive load). Added Section 2.1: Electrical characteristics (curves).
31-Mar-2015	4	Added device in TO-247 long leads. Updated 4: Package information. Updated Figure 7, Figure 11, Figure 14, Figure 15, Figure 20, Figure 21 and added Figure 26. Minor text changes.
28-Jun-2016	5	Modified: <i>Table 2: "Absolute maximum ratings"</i> , <i>Section 2: "Electrical characteristics"</i> , <i>Table 6: "IGBT switching characteristics (inductive load)"</i> Minor text changes.

IMPORTANT NOTICE – PLEASE READ CAREFULLY

STMicroelectronics NV and its subsidiaries ("ST") reserve the right to make changes, corrections, enhancements, modifications, and improvements to ST products and/or to this document at any time without notice. Purchasers should obtain the latest relevant information on ST products before placing orders. ST products are sold pursuant to ST's terms and conditions of sale in place at the time of order acknowledgement.

Purchasers are solely responsible for the choice, selection, and use of ST products and ST assumes no liability for application assistance or the design of Purchasers' products.

No license, express or implied, to any intellectual property right is granted by ST herein.

Resale of ST products with provisions different from the information set forth herein shall void any warranty granted by ST for such product.

ST and the ST logo are trademarks of ST. All other product or service names are the property of their respective owners.

Information in this document supersedes and replaces information previously supplied in any prior versions of this document.

© 2016 STMicroelectronics – All rights reserved