

# SHARP

Electronic Components  
July 2007

For Your Creative Products

---

# ELECTRONIC COMPONENTS

---



<http://sharp-world.com/products/device/>

# CONTENTS

Advanced Measures for Environmental Conservation as Management Policy.....	2
--	---

## STN CSTN TFT CG Silicon

LCD Modules .....	8
-------------------	---

## EL

EL Display Modules.....	14
-------------------------	----

## LSI REG

### CMOS IMAGE SENSORS

CMOS Camera Modules .....	15
---------------------------	----

### CCDs

Higher-resolution CCDs .....	16
1/3-type CCDs.....	16
1/3.8-type CCD .....	17
1/4-type CCDs.....	17
1/3-type CCDs with Dual-power-supply (5 V/12 V) .....	17
Operation .....	17
CCD Peripheral ICs/LSIs.....	18

### LSIs FOR LCDs/ANALOG ICs

For Notebook PCs, PC Monitors and LCD TVs.....	25
For Mobile Equipment .....	26
For Mobile Phones .....	27
Peripheral ICs for LSIs for LCDs .....	29

### SYSTEM LSIs

Special-function LSIs .....	31
IPs .....	32

### SMART CARD SYSTEMS

Smart Cards/LSI Modules for Smart Cards .....	33
Reader/Writer for Smart Cards .....	34
SDK (Software Development Kit) for Smart Cards.....	34

### FLASH MEMORIES AND COMBINATION MEMORIES

<b>FLASH MEMORIES</b> .....	35
-----------------------------	----

<b>SYSTEM-FLASH</b> .....	36
---------------------------	----

#### HIGHLY FUNCTIONAL FLASH MEMORIES

Boot Block Type 3 V Page Mode Flash Memories.....	38
---	----

#### STANDARD FLASH MEMORIES

Boot Block Type 3 V Flash Memories.....	38
---	----

#### SYSTEM-FLASH

Fast-Reprogramming System-Flash for Digital Equipment ..	39
System-Flash for Amusement Products.....	39
System-Flash for Automotive Use.....	40
System-Flash for Network Equipment.....	40

#### COMBINATION MEMORIES

Boot Block Type Flash Memory + Pseudo SRAM .....	41
--	----

### POWER DEVICES/ANALOG ICs

Low Power-Loss Voltage Regulators.....	42
Surface Mount Type Low Power-Loss Voltage Regulators ...	44
Surface Mount Type Chopper Regulators (DC-DC Converters).....	48
Chopper Regulators (DC-DC Converters) .....	49
Power Supply ICs for CCDs/CCD Camera Modules .....	50
Power Supply ICs for TFT-LCDs.....	50
Fail Safe IC.....	51
LED Drivers .....	51
Laser Diode Drivers .....	52

#### ANALOG ICs

Video Interface ICs for TFT-LCDs.....	53
Power Amplifiers for Wireless LAN.....	53
ICs for Audio Equipment .....	54

### PACKAGES

CSP (Chip Size Package).....	55
LGA (Land Grid Array Package).....	56
SiP (System in Package).....	57
SOF (System On Film) .....	59
Package Lineup .....	60

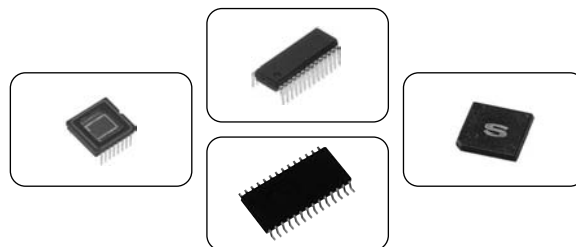

## OPTO

### OPTOELECTRONICS

<b>Photocoupler Index Tree</b> .....	67
--------------------------------------	----

#### Photocouplers

Phototransistor Output.....	68
OPIC Output .....	72

#### Phototriac Coupler Index Tree

Phototriac Couplers .....	76
---------------------------	----

#### Solid State Relay Index Tree

Solid State Relays .....	79
--------------------------	----

#### Photointerrupter Index Tree

Photointerrupters <Transmissive type> .....	83
Single Phototransistor Output.....	83
Darlington Phototransistor Output .....	85
OPIC Output .....	85

#### Photointerrupters <Reflective type>

Single Phototransistor Output.....	87
Darlington Phototransistor Output .....	88
OPIC Output .....	88

#### Photointerrupters for Specific Applications

Transmissive Type.....	89
Reflective Type.....	91

#### Phototransistor Index Tree

Phototransistors.....	93
-----------------------	----

#### Photodiodes/OPIC Light Detectors

PIN Photodiodes.....	94
PSD (Position Sensitive Detector) .....	94
Blue Sensitive Photodiodes .....	94
Laser Power Monitoring Photodiodes	

for Optical Disc System .....	95
-------------------------------	----

RGB Color Sensor.....	95
-----------------------	----

Ambient Light Sensors .....	95
-----------------------------	----

#### Infrared Emitting Diode Index Tree

Infrared Emitting Diodes .....	101
--------------------------------	-----

#### Optical-Electric Sensor Index Tree

Distance Measuring Sensor Lineup.....	102
---------------------------------------	-----

Wide Angle Sensor Lineup .....	102
--------------------------------	-----

High-Precision Displacement Sensor .....	102
--	-----

Paper Size Sensor Lineup .....	102
--------------------------------	-----

Dust Sensor Unit Lineup.....	102
------------------------------	-----

Color Toner Concentration (Deposition Amount) Sensor Lineup .....	102
---	-----

Distance Measuring Sensors.....	103
---------------------------------	-----

Wide Angle Sensors .....	104
--------------------------	-----

Paper Size Sensors .....	105
--------------------------	-----

High-Precision Displacement Sensor .....	106
--	-----

Dust Sensor Units.....	106
------------------------	-----

Color Toner Concentration (Deposition Amount) Sensors....	106
---	-----

#### Fiber Optics Index Tree

Fiber Optics Lineup for Audio Equipment .....	107
---	-----

Transmission/Reception Devices for MOST Compatible	
Optical Fiber .....	107
Fiber Optic Transmitters .....	108
Fiber Optic Receivers .....	109
Optical Transmission Device .....	110
Optical Reception Device .....	110

## LED

### LED

High-Luminosity LED Lamps .....	111
LED Lamps .....	113
Dichromatic LED Lamps .....	115
High-Luminosity Chip LEDs .....	116
Chip LEDs .....	117
High-Luminosity Dichromatic Type Chip LEDs .....	117
Dichromatic Type Chip LEDs .....	118
High-Luminosity White Type Chip LEDs .....	118
Pastel Color Chip LEDs .....	118
High-Luminosity Dichromatic Type Chip LEDs (RGB 3-color) .....	119
LEDs for Camera Data Back .....	119



## LASER

### LASER DIODE

Laser Diodes .....	120
--------------------	-----

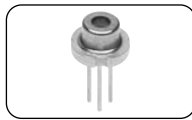

## RF

### RF COMPONENTS

Low Noise Blockdown Converter	
Europe: LNB for Broadcasting Satellite .....	121
U.S.A.: LNB for FSS Broadcast/(Others: LNB for Communication) .....	121
Japan/Asia/Australia: LNBs for CS Digital Satellite Broadcast .....	122
Japan: LNBs for BS/CS 110° Satellite Broadcast .....	122
Digital DBS Front-End Units .....	123
QPSK Demodulator Circuit Built-in Type .....	124
8 PSK Demodulator Circuit Built-in Type .....	124
Combination Front-End for Digital Terrestrial and Digital Satellite Broadcasting .....	125
Digital Terrestrial Front-End Unit .....	126
Front-End Units for ISDB-T/DVB-T .....	126

Two-In-One RF Units .....	127
Analog Terrestrial RF Front-End Unit .....	128
RF Front-End Units .....	128
1-Segment Digital Terrestrial Module .....	129
1-segment/3-segment Digital Terrestrial Module .....	129
USB Interface Wireless LAN Module .....	130



## IR

### IR DEVICE

Infrared Data Communication Device Index Tree .....	131
Infrared Data Communication Devices .....	132
Infrared Wireless Audio Transmission Device .....	133
IR Detecting Unit for Remote Control Index Tree .....	134
IR Detecting Units for Remote Control .....	135



## POWER

Switching Power Supplies (Custom) .....	137
Switching Power Supply with Integrated High/Low Voltage Circuit (Custom) .....	137

## PCB

### PRINTED CIRCUIT BOARD

Advanced Flex Printed Circuit Boards .....	138
Flexible Build-up Multilayer PCBs .....	139
Flexible Printed Circuit Boards .....	140

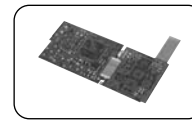

## UNIT

### PICKUP

Slim Combo Drive Pickup .....	141
Slim DVD-ROM Drive Pickup .....	141
DVD Pickup for Automotive Use .....	141

# Advanced Measures for Environmental Conservation

In accordance with environmental guidelines established under Sharp's Basic Environmental Philosophy, the Sharp Group Charter of Corporate Behavior, and the Sharp Code of Conduct, Sharp is pursuing environmental conservation in all aspects of its business activities. Since fiscal 2004, when the medium-term brand objective of becoming an environmentally advanced company was first set, Sharp has been promoting the Super Green Strategy to achieve its corporate vision and to establish sustainable manufacturing systems.

## ● Basic Environmental Philosophy ●

### Creating an Environmentally Conscious Company with Sincerity and Creativity

#### ● The Sharp Group Charter of Corporate Behavior ●

#### Contribution to Conservation of the Global Environment

The Sharp Group will fulfill our responsibility for environmental conservation by promoting the creation of proprietary technologies that contribute to protection of the global environment, and by carrying out our product development and business activities in an environmentally conscious manner.

#### ● The Sharp Code of Conduct ●

#### Contribution to Conservation of the Global Environment

##### 1. To Conserve the Environment:

- ① We will comply with all applicable environmental laws, regulations and territorial agreements, and work to practice efficient use and conservation of resources and energy voluntarily, in the recognition that environmental conservation is an essential facet of corporate and individual pursuits.
- ② We will ensure proper use and control of chemical substances in our business activities including research, development and manufacturing, meeting or exceeding levels determined by laws and regulations.
- ③ We will engage in the active acquisition, reporting and promotion of environmental information at an international level, as the Sharp Group companies promote communication with shareholders and local residents.
- ④ We understand the importance of internal company systems and related details in acquiring third-party certification and recertification of our ISO environmental management systems, and we will conduct our business operations in accordance with relevant internal guidelines.

##### 2. To Develop Environmentally Conscious Products and Services, and Conduct Our Business Operations in an Environmentally Conscious Manner:

- ① We will engage positively in the minimization of resource use, reduction in the size and weight of products, use of recycled materials, and the development of long-lasting, energy-saving, energy-creating products.
- ② We will work to compile information related to harmful substances that might damage the environment or human health, and will not, as a matter of principle, make use of these harmful substances in our products, services and business activities.
- ③ We will use recyclable materials wherever possible, with product development focused as a matter of policy on structures that are detachable or capable of dismantling, and suited to recycling.
- ④ We will work aggressively to reduce greenhouse gas emissions in the full range of our business activities, in order to contribute to the prevention of global warming.
- ⑤ We will work to conduct our business in such a way to select and purchase materials that are harmless to the global environment, and to local residents and employees, for the resources needed for business activities (equipment, raw materials, subsidiary materials, tools, etc.).
- ⑥ We realize that waste material is a valuable resource, and we will actively conduct our business operations in such a way as to maximize the 3Rs (reduce, recycle and reuse) and will contribute to minimizing the amount of waste sent for permanent landfill disposal.

\* The Sharp Group Charter of Corporate Behavior and the Sharp Code of Conduct were instituted in May 2005 as a revised edition of the preceding Sharp Charter of Conduct (instituted in 2003). The section above is an excerpt from descriptions of Sharp's environmental conservation efforts. For more information: <http://sharp-world.com/corporate/eco/report/index.html>

# as Management Policy

## Corporate Vision of Achieving “Zero Global Warming Impact by 2010”

Sharp will limit to the greatest extent possible the amount of the greenhouse gas emissions resulting from its business activities around the world, while at the same time, significantly help reduce greenhouse gas emissions based on the energy-creating effects of solar cells and the energy-saving effects of products. The idea is for the amount of greenhouse gas emissions reduced to exceed the amount emitted by fiscal 2010.

Sharp's greenhouse gas emissions in fiscal 2006 were approximately 1.73 million t-CO<sub>2</sub>. At the same time, it is estimated that the solar cells Sharp produced over the 20 years up to fiscal 2005 generated approximately 1,322 GWh<sup>\*1</sup> in fiscal 2006. This is equivalent to a reduction in greenhouse gas emissions of approximately 0.56 million t-CO<sub>2</sub><sup>\*2</sup>.

\*1 Calculation based on 844 MW, Sharp's total solar cell production over 20 years from 1986 to 2005.

\*2 Calculated using a CO<sub>2</sub> emission unit of 0.425 kg/kWh (fiscal 2005) at the receiving end, announced by the Federation of Electric Power Companies of Japan.

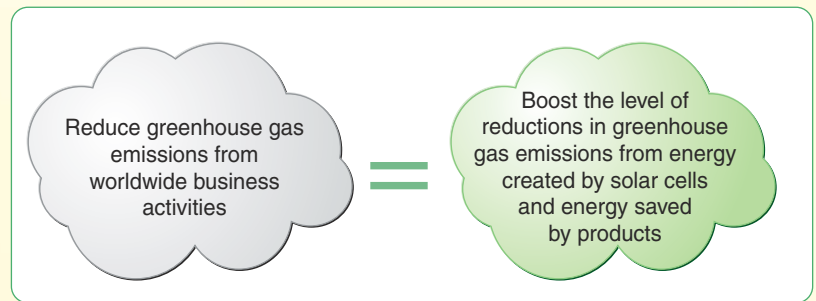

## Super Green Strategies to Become an Environmentally Advanced Company

**SGT**  
**Super Green Technologies**  
 Developing unique environmental technologies that contribute to environmental conservation

**SGR**  
**Super Green Recycling**  
 Recycling used products to promote resource recycling

**SGM**  
**Super Green Management**  
 Enhancing environmental sustainability management

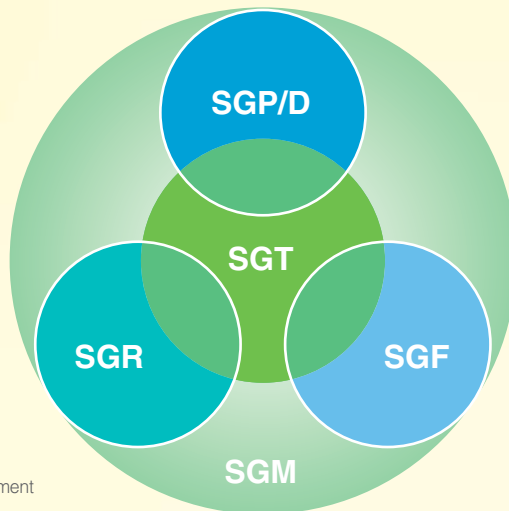

**SGP/D**  
**Super Green Products and Devices**  
 Creating products and devices with high environmental performance

**SGF**  
**Super Green Factories**  
 Factories with high environmental consciousness and trust from communities



# Becoming an Environmentally Advanced Company—

## Developing Super Green Technologies

To achieve Sharp's corporate vision of becoming a company that has "zero global warming impact by 2010," the development of superior environmental technologies is an essential factor in the environmental performance of products and devices and the reduction of environmental impact during production.

Sharp conducts research and development in four areas of environmental technology: reduction of CO<sub>2</sub> emissions, effective use of resources, elimination of use of harmful substances, and promotion of health and cleanliness.

Sharp recognizes the most important technologies in these areas as one-of-a-kind environmental technologies—key technologies for achieving global environmental conservation—and develops them under a company-wide development strategy. These technologies enhance environmental performance of products and devices, reduce environmental impact at plants, and facilitate recycling. Unique technologies, evolving from these developments, are what Sharp calls Super Green Technologies.

■ One-of-a-Kind environmental technological development fields that give birth to Super Green Technologies

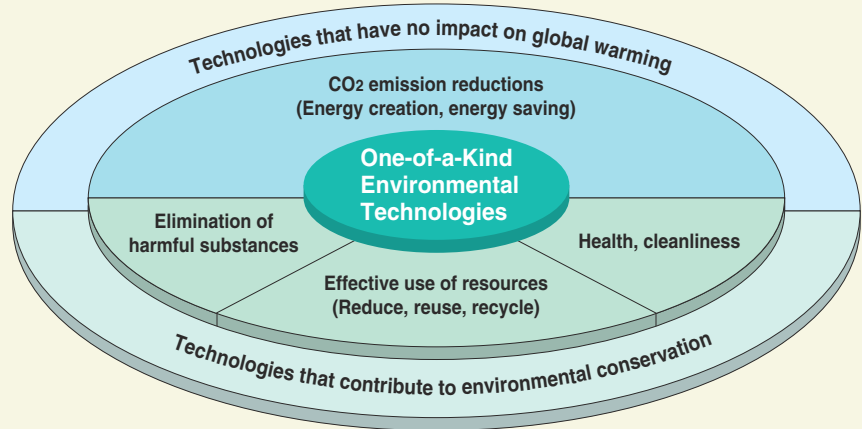

## Development of Green Devices and Super Green Devices

Sharp calls its environmentally conscious devices "Green Devices." To define criteria for development and design based on seven concepts such as low energy consumption and recyclability, Sharp established the Green Device Guidelines, which it began applying in fiscal 2004. In fiscal 2005, Sharp began certifying Green Devices that attain the highest possible levels of environmental performance as "Super Green Devices."

The development of Green Devices begins at the planning and designing stage, where every aspect of the product's environmental impact is discussed. Sharp then sets specific objectives based on the Green Device Standard Sheet. Finally, in the trial manufacture and mass production stages, Sharp determines how well the actual product has met its objectives.

In fiscal 2006, both Green Devices and Super Green Devices exceeded their sales ratio targets. In the coming years, Sharp plans to raise these figures even higher.

\*1 Certification criteria for Green Devices and Super Green Devices in fiscal 2006: Green Devices had to satisfy at least 90% or more of all 20 assessment items (9 of which are compulsory) listed in the Environmental Performance Criteria. Super Green Devices will have to satisfy at least 95% or more the 20 assessment items (10 of which are compulsory) listed in the Environmental Performance Criteria. At the same time, they must be either the industry's No. 1, or the industry's first devices in at least one item of the External Environmental Claim Standards.

■ The Green Device concept

Energy saving	Reduce total power consumption and reduce power consumed in standby mode compared to previous models
Recyclability	Use standard plastic or materials that are easy to separate and disassemble (target: LCD devices)
Resource saving	Reduce weight or volume compared to previous models
Green material	Control usage of chemical substances contained in parts and materials and use no substances prohibited under Sharp standards
Long life	Extend the life of the product with exchangeable parts and consumables (target: LCD devices)
Packaging	Reduce packaging materials
Information disclosure	Provide information on chemical substances

# Super Green Technologies, Devices and Factories

## Achievement of a Super Green Factory

Sharp is systematically acting to enhance the environmental consciousness of its production sites worldwide. Sharp has established proprietary assessment standards to rank factories with high environmental consciousness as Green Factories, and those with extremely high environmental consciousness as Super Green Factories, Sharp is planning to convert all its production sites around the world into Green Factories or higher by fiscal 2007.

### ■ The Green Factory concept

Greenhouse gases	Minimize emission of greenhouse gases	Atmosphere, water, soil	Minimize environmental burden on the atmosphere, water and soil
Energy	Minimize energy consumption	Harmony with nature	Endeavor to preserve nature both on and off site
Waste	Minimize discharge of waste	Harmony with the community	Encourage harmony with the local community
Resources	Minimize resource consumption	Environmental consciousness	High environmental awareness among employees
Chemical substances	Minimize risk of environmental pollution and accidents caused by chemical substances	Information disclosure	Disclose information on the environment

## Certification of Green Factories and Super Green Factories

Quantified environmental performance criteria are used to assess and approve a plant for certification. A plant must score 70 or more points out of a possible 100 in the assessment process to earn Green Factory certification, while scoring 90 or more points will result in Super Green Factory certification. Plans call for turning all Sharp Corporation production sites in Japan into Super Green Factories and all production sites in the Sharp Group to Green Factories or higher by the end of fiscal 2007. In fiscal 2006, three domestic bases and two overseas bases achieved Super Green Factory status, while a total of 10 bases in Japan and overseas earned Green Factory certification.

### ■ Process required to achieve Super Green Factories

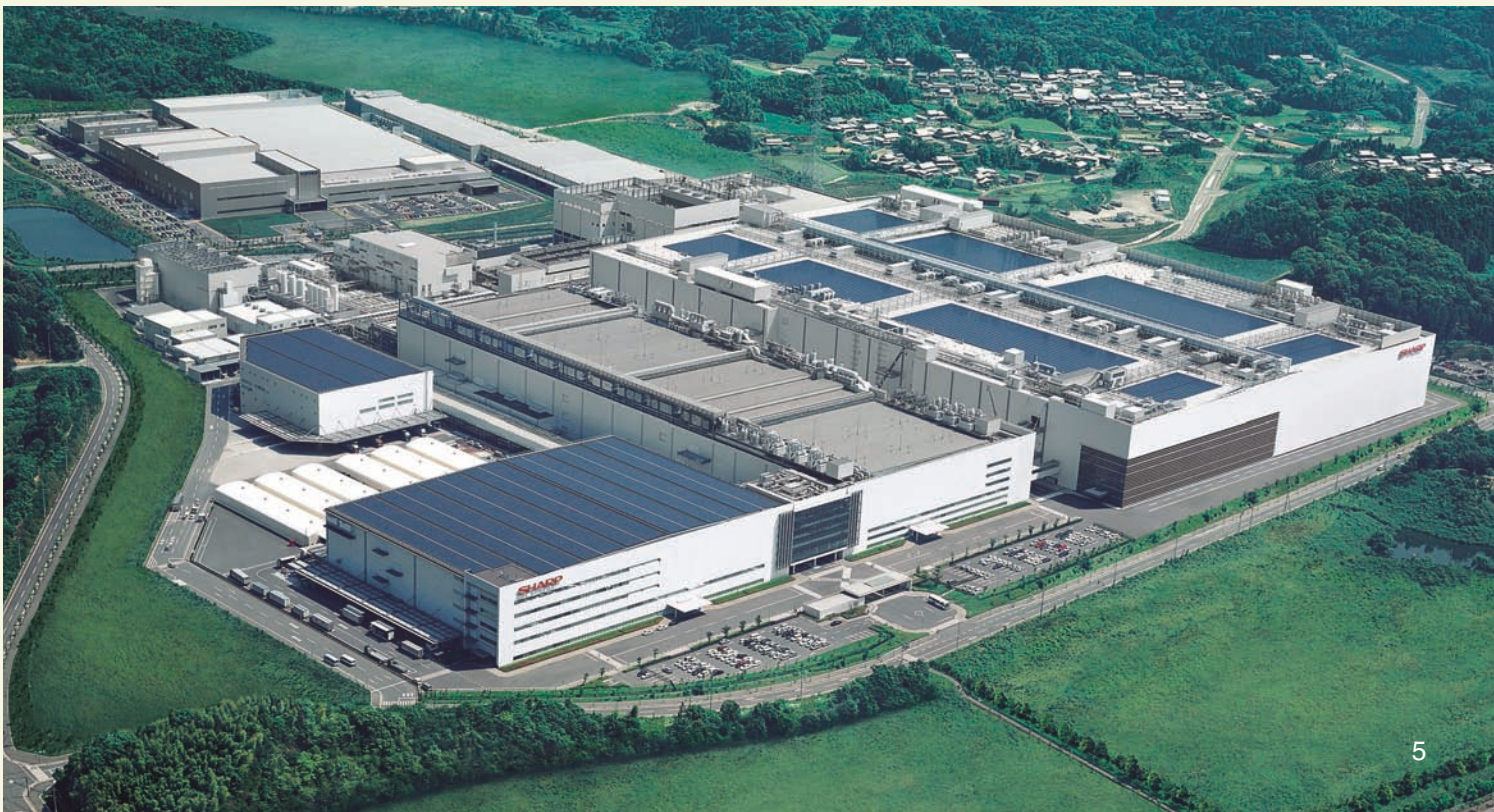
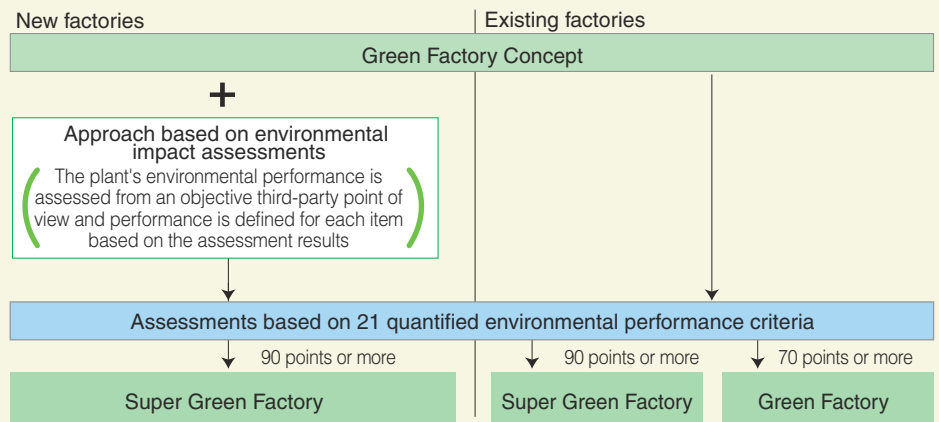



# From “Green” Factories to “Super Green” Factories

## Sharp’s First Super Green Factory Kameyama Plant

### AVC Liquid Crystal Display Group (Kameyama, Mie Prefecture)

The Kameyama Plant is Sharp’s first “Super Green Factory”, a compilation of the company’s environmental protection technologies. In preparing for construction, we gave a great deal of careful consideration to protecting the environment, beginning at the initial design stage. Working in consultation with local governments and with nearby residents, we carefully selected the parameters that would be subject to environmental protection measures. We chose the standards that would apply, and confirmed them through evaluation by independent experts. Also, when building the Kameyama Plant No. 2, we took the opportunity to introduce the latest environmental technology to make it one of the world’s most advanced “Super Green” factories.



#### An Efficient and Environment-Friendly Integrated Production System

The entire process is carried out in a single plant—from fabricating the LCD panels to final assembly. This system makes it possible to consolidate technical departments and strengthen our development capabilities, as well as shorten the lead-time from order to shipping. Eliminating the need to ship sub-assemblies between distant plants has also enabled us to slash the amount of packaging materials required for shipping and reduce emissions such as carbon dioxide (CO<sub>2</sub>).

#### Countering Global Warming by Unifying Diverse Power Sources Distributed over a Wide Area

The Kameyama plant generates one-third of its annual electricity consumption and has reduced CO<sub>2</sub> emissions to about 40% lower than previous levels by means of a cogeneration system\* using liquefied natural gas (LNG) (approx. 26,400 kW), as well as one of the largest fuel cell systems in Japan (approx. 1,000 kW), and one of the world’s largest photovoltaic (PV) power generation systems (5,210 kW).

\* Cogeneration system: A system designed to save energy by using city gas to generate electricity. The waste heat generated is then used in applications such as air conditioning, hot water supply and steam electricity generation.

#### The Kameyama Plant Receives Japan Sustainable Management Award

The Kameyama Plant in Japan was recognized for its outstanding environmental sustainability management by being chosen from among 125 applicants for the highest honor, the Sustainable Management Pearl Award, in the 2004 Japan Sustainable Management Awards\* (sponsored by the Japan Sustainable Management Awards Committee and Mie Prefecture). This award shows the high esteem for the environmental measures—including 100% recycling of manufacturing process wastewater, the introduction of an LNG cogeneration system and the installation of a photovoltaic power system—taken by the Kameyama Plant, Sharp’s first Super Green Factory.

The Kameyama Plant received the first Minister of Economy, Trade and Industry Award in the 8th Japan Water Prize (2006) and the Energy Saving Encouraging Prize in the 4th Excellent Cogeneration System Commendation (FY 2005) sponsored by the Japan Cogeneration Center.

\* The Japan Sustainable Management Awards honor all organizations across the nation, no matter what their size or type of business—including private companies, NPOs and schools—that demonstrate outstanding results of their environmental sustainability management efforts.

#### Creating Energy at the Factory for Energy-Saving Products, Using One of the World’s Largest\* PV Power Generation Systems

In addition to the existing 60-kW photovoltaic (PV) power generation system, new PV power generation systems, in a total area of approx. 47,000 m<sup>2</sup> and with a total output of 5,150 kW, have been installed. Located at the large-screen LCD TV factory, the distribution building, and on the roof and curtain wall of the Kameyama Plant No. 2, these systems generate an annual electricity output that would power 1,300 average Japanese households.

\* As a building-installed system. Survey by Sharp.

#### Water Purifying System—100% Water Recycling in the Production Process

The plant collects all the wastewater from the production process of liquid crystal panels, etc. (max. 28,300 tons a day) and recycles it 100% with water purification techniques using microorganism treatment. Malodorous wastewater containing chemicals is deodorized using peat moss\* from Ishikari River, Hokkaido.

\* Bog moss decomposed and piled up for several thousands of years.

## Mie Plant Becomes First Existing Factory to Achieve Super Green Status

### Mobile Liquid Crystal Display Groups (Taki, Mie Prefecture)

The results described above are major efforts in upgrading to a Super Green Factory.

#### Fluoric Acid Effluent Recycling System Honored at 2004 WASTEC Award

The Mie Plant No. 3 uses fluoric acid in its continuous grain silicon production process. The plant developed this system and has been using it since 2004 to recover and recycle the fluoric acid effluent. This system was recognized for its excellence and won the Business Activity Category Prize at the 2004 WASTEC (Waste Control and Recycling Technology Exhibition) Awards in Japan in November 2004. Prior to the introduction of this system, the fluoric acid from the effluent was used to make cement. Now it can be used repeatedly at the production site, while the distilled water from the effluent can be used as pure water.

#### Waste Reduction Efforts

In 2004, we achieved zero discharge to landfill, eliminating waste by recycling all possible waste materials. Efforts are being made to further reduce emission of waste products by expanding the sale of valuable materials for reuse.

#### Energy-Saving Efforts

Since its completion, the Mie Plant has been strongly focused on energy conservation. In fiscal 2006 our efforts were recognized with an Agency for Natural Resources and Energy Director-General Prize for energy-efficient plant management. In addition, three members of the Mie Environmental Safety Promotion Center, who have been engaged in energy-saving efforts for many years, received prizes in recognition of their achievements in energy management. These awards are a testament to Sharp’s energy management and energy-saving efforts.

#### CO<sub>2</sub> Emissions Reduced through PV Power System Installation

The Mie Plant No. 3 installed a 180-kW photovoltaic power system on its south exterior wall. The system began generating electricity in March 2005. Used mainly to provide lighting for all non-manufacturing rooms, the system generated 141,000 kWh of power in 2006 and contributed to the reduction of about 60 tons of CO<sub>2</sub> emissions.



#### Participation in Environmental Education Programs at Local Schools

As part of our community outreach program, we have been cooperating with eight local schools in the town of Taki (one senior high, two junior high, and five elementary schools) on various educational projects, including factory tours, classes taught by visiting lecturers, and joint environmental activities.

#### Participation in Local Environmental Activities

The Mie Plant is actively involved in mitigating the impact of the plant on the surrounding environment, and is also engaged in local environmental preservation activities focused on the area’s mountains, rivers, and roads. We have received acclaim from local people for our participation in these activities, including the upkeep of the local forest as a water source, the maintenance of the neighboring forests and mountains, the cleaning of the Sanagawa River as the plant’s effluent stream, and the planting of flowers on National Route 42.



## Green Factory Activities at Key Electronic Device Factories



**Advanced Development and Planning Center/  
Corporate Research and Development Group  
(Tenri, Nara Prefecture)**

ISO 14001 certification: December 3, 1996

### Adoption of a cogeneration system\*

About 26% of facility power is provided through private power generation. Waste heat is used for heating or cooling and also supplied to a steam generator for power generation. This cuts facility CO<sub>2</sub> emissions by about 13%.

Municipal gas is supplied by pipeline, so there is no discharge of CO<sub>2</sub>, nitrogen oxides or other pollutants from truck transport.

\* An energy saving system that generates power using municipal gas and uses the produced waste heat for heating or cooling, hot water supply and steam electricity generation, etc.

### Installation of a solar generation system

Installation of solar panels with a generating capacity of 40 kW.

### Relations with the local community

As the only Sharp establishment that has an ancient burial mound on its grounds, the center's employees are actively involved in the maintenance of the mound. In August of each year, the center invites employees and their families and local people to a "Sharp Festa." An environmental exhibition space is prepared to showcase the environmental activities of the center.

### Waste fluid processing system based on natural purification\*

Waste and the pollution load of released water are reduced by using a waste fluid treatment system for waste water containing alcohol or other organic components.

After treatment, water is given further high-level treatment and used as intermediate factory water, to ensure more effective use of water resources.

\* A natural purification system based on micro-organisms, developed independently by Sharp. (Patented)

### Promotion of zero emissions\*

Zero emissions were achieved in 2002 through reclamation of waste into useful resources for other business fields. Efforts will continue to further reduce waste emissions.



**Solar Systems Group  
Electronic Components Group  
(Katsuragi, Nara Prefecture)**

ISO 14001 certification: June 25, 1996

### Prevention of water pollution

All waste water from production processes and laboratories is purified at a waste water treatment station within the factory. Water is released into the sewer only after treatment based on voluntary standards stricter than environmental standards.

### Prevention of air pollution

Waste gases from acids and organic solvents produced by production processes and laboratories are purified with two types of waste gas treatment equipment, depending on the properties of the chemical substances. Eight acid scrubbers and 11 solvent scrubbers are installed on the roof of the Katsuragi Plant, and these keep atmospheric emissions of chemical substances below 1/10th of regulatory levels.

### Promotion of zero emissions\*

In 2001, the factory achieved zero emissions through recycling of all materials. It is now working to reduce waste volume with the goal of a final disposal rate of 0.2%.

### Installation of solar generation system

In 2003, solar panels were installed at the solar park on the roof of the No. 3 Plant and on the employee recreation building. At present the solar generation system has a total capacity of 194.5 kW, and this electricity is used for tasks such as air conditioning.

### Relations with the local community

In October of each year, the factory holds a "Katsuragi Festa" to improve relations with the local community and showcase the site's environmental activities.

### From a Green Factory to a Super Green Factory

With the aim of becoming a Super Green Factory in 2007, the site is working to reduce emissions of harmful chemical substances used in processes and to recycle cleaning water used in production.



**LSI Group  
(Fukuyama, Hiroshima  
Prefecture)**

ISO 14001 certification: September 24, 1996

### Inauguration of a non-dilution nitrogen treatment plant

The Group built a new plant that uses the world's first non-dilution treatment technology on the nitrogen contained in semiconductor plant wastewater. The technology combines "micro-nanobubble technology" with a unique microorganism treatment technology Sharp developed in June 2005. Operation of the plant began in July 2006.

### Promotion of zero emissions\*

Zero emissions were achieved in 2001 through ongoing efforts such as in-house treatment of developing fluid by means of our own micro-organism treatment technology, reduction of the volume of process sludge produced, and recycling of waste into useful material.

### Prevention of global warming

An energy conservation committee has been formed to promote energy conservation efforts involving the entire Group. Efforts such as building a unique energy-saving outer air treatment system have been highly regarded, and the Group received a "2005 Excellent Energy Conservation Factory & Building (electricity category)" award from the Director-general of the Agency for Natural Resources and Energy.

### Relations with the local community

In August of each year, employees and their families and local people are invited to the "Family Day in Sharp (Summer Festival)." At this festival, an environmental exhibition space is prepared to provide an opportunity for people to experience nature and to introduce the environmental protection efforts of the facility.

The plant also implemented the semiconductor industry's first full-scale risk communication panel (July 2005), and in cooperation with the local community, jointly produced a large communication panel (4 m x 6 m) called "Daimoncho—Yesterday and Today." The panel is on display at our premises and is being used to introduce our business and Daimoncho to visitors.

Communication activities such as these have been highly evaluated, and the Group received the "2005 PRTR Prize" sponsored by the Center for Environmental Information Science.



**Electronic Components Group  
Mihara Plant  
(Mihara, Hiroshima Prefecture)**

ISO 14001 certification: November 17, 2003

### Prevention of global warming

The precise air-conditioning necessary for production activities is maintained by operating coolers and boilers on municipal gas, which produces little CO<sub>2</sub>. The turbo coolers provided in air-conditioning equipment use a waste heat recovery system. A remover optimized for greenhouse gases is provided to suppress emission of such gases and prevent global warming.

### Promotion of zero emissions\*

Zero waste emission has been achieved through active efforts to reduce and reclaim waste, instituted from the beginning of the facility.

### Efforts to prevent pollution

After treatment at an in-house facility, all process waste water is discharged into the public sewer only after clearing voluntary standards stricter than waste water standards. Sludge produced in waste water treatment is sorted by type and reclaimed.

Measures are taken such as installing equipment indoors to prevent noise escaping to the surrounding area from noisy equipment, such as large fans and large compressors. Noise levels at the site boundary are within regulation values.

The plant is working to improve management of chemical substances, prevent accidents and environmental disasters, and reduce environmental impact.

### Efforts to contribute to the local community

Through efforts such as inviting local people to festivals and activities to protect forests, the plant aims to deepen relations with people in the local area and protect the environment.

Efforts are being made to beautify the area by participating in greening activities in the Mihara Western Industrial District where this facility is located.

Efforts are being made to issue a pamphlet introducing the facility and to disclose information. The pamphlet contains environmental activity records and other information.

\* Sharp defines this as bringing the amount of buried waste (final disposal amount) as close to zero as to be negligible.

In figures, a final disposal rate of less than 0.5% (final disposal rate = buried amount / total discharged amount x 100) is taken to be zero emissions.



## ■ LCD Modules

### <For industrial appliances> (1)

	Display size	Model No.	Number of pixels (dot) H × V	Pixel pitch (mm) H × V	Display colors	Luminance (cd/m <sup>2</sup> )	Input video signal	Power consumption (W)	Outline dimensions (mm) W × H × D	Weight (g)	Backlight	Remarks				
	28.3" (72cm)	LQ283G1TW11	2 560 × RGB × 2 048	0.219 × 0.219	16.77 M	225	4ch TMD5	103.2	640.0 × 530.0 × 60.0	Max. 15 000	18CCFT	Built-in inverter				
	28.1" (71cm)	LQ281L1LW11	2 048 × RGB × 2 048	0.246 × 0.246	16.77 M	225	4ch LVDS	96.0	594.0 × 594.0 × 83.0	15 000	18CCFT	Built-in inverter				
		☆LQ281L1LW14						TBD								
	23.1" (59cm)	LQ231U1LW01	1 600 × RGB × 1 200	0.294 × 0.294	16.77 M	250	LDI	54.9	530.0 × 432.8 × 32.5	Max. 5 500	6CCFT	Built-in inverter				
		LQ231U1LW21										Expanded backlight brightness adjustment area				
	20.1" (51cm)	LQ201U1LW11Z	1 600 × XYZ × 1 200	0.255 × 0.255	256 (gray scales)	700	2ch LVDS 8 bit XYZ	32.9	436.0 × 335.0 × 27.5	Max. 3 800	6CCFT					
		LQ201U1LW21	1 600 × RGB × 1 200		16.77 M	250	2ch LVDS 8 bit RGB	33.8	432.0 × 331.5 × 25.0	3 200						
	19.0" (48cm)	LQ190E1LW01	1 280 × RGB × 1 024	0.294 × 0.294	16.77 M	300	2ch LVDS 8 bit RGB	25.5	404.2 × 330.0 × 20.0	Max. 2 800	4CCFT					
		LQ190E1LW41						450	38.3	404.2 × 330.0 × 22.0	Max. 3 200	6CCFT				
TFT	15.0" (38cm)	LQ150X1LGB1	1 024 × RGB × 768	0.297 × 0.297	16 M	600	LVDS 6 bit + 2FRC RGB	16.0	331.6 × 254.76 × 12.5	1 200±50	4CCFT					
		LQ150X1LGN2A						260	9.8			326.0 × 252.0 × 11.5	Max. 1 100	2CCFT		
		LQ150X1LGN2E						350	10.4							
		LQ150X1LW71N						250	18.1	331.6 × 254.76 × 12.5	Max. 1 300	4CCFT	Advanced Super View LCD			
		LQ150X1LW72						350			Max. 1 350					
		☆LQ150X1LGB2						(200)	TBD	(331.6 × 254.76 × 16.0)	(Max. 1 400)	2CCFT	VeilView			
	12.1" (31cm)	LQ121S1DG41	800 × RGB × 600	0.3075 × 0.3075	260 k	370	Digital 6 bit RGB	8.3	276.0 × 209.0 × 11.0	Max. 660	2CCFT	Strong LCD2				
		LQ121S1DG61											450	Max. 800		
		LQ121S1LG41											370	Max. 660		
		LQ121S1LG61											450	Max. 800		
☆LQ121S1LG64		(450)								(8.3)	276.0 × 209.0 × 14.5	(1 200)		Low reflection LCD module		
LQ121S1LW01		250								8.5	276.0 × 209.0 × 11.0	Max. 800	2CCFT	Advanced Super View LCD		
☆LQ121S7LY01		(200)								15.5	276.0 × 216.0 × 16.0	(Max. 800)		Super Mobile LCD		
☆LQ121S7LY11		(300)										(Max. 900)	4CCFT			
10.4" (26cm)	LQ104S1DG21	800 × RGB × 600	0.264 × 0.264	260 k	350	Digital 6 bit RGB	6.5	246.5 × 179.4 × 15.5	Max. 620	2CCFT	Strong LCD2					
	LQ104S1DG31											350	6.6	243.0 × 183.8 × 11.5	Max. 600	
	☆LQ104S1DG61											420	(6.3)	246.5 × 179.4 × 13.7	Max. 620	
	LQ104S1LG21											350	6.6	246.5 × 179.4 × 15.5		
	☆LQ104S1LG31											350	(6.6)	243.0 × 183.8 × 11.5	(600)	
	☆LQ104S1LG61											420	(6.3)	246.5 × 179.4 × 13.7	Max. 620	

**Notice**

In the absence of confirmation by device specification sheets, SHARP takes no responsibility for any defects that may occur in equipment using any SHARP devices shown in catalogs, data books, etc. The models listed on this page are lead-free solder compatible. For details, please inquire with SHARP. Contact SHARP in order to obtain the latest device specification sheets before using any SHARP device.

## <For industrial appliances> (2)

	Display size	Model No.	Number of pixels (dot) H × V	Pixel pitch (mm) H × V	Display colors	Luminance (cd/m <sup>2</sup> )	Input video signal	Power consumption (W)	Outline dimensions (mm) W × H × D	Weight (g)	Backlight	Remarks
TFT	10.4" (26cm)	LQ104V1DG21	640 × RGB × 480	0.330 × 0.330	260 k	350	Digital 6 bit RGB	6.4	265.0 × 195.0 × 11.5	Max. 700	2CCFT	Strong LCD2 Low reflection LCD module Advanced Super View LCD
		LQ104V1DG51							246.5 × 179.4 × 15.5			
		LQ104V1DG61							246.5 × 179.4 × 13.7			
		☆LQ104V1DG64				(246.5 × 179.4 × 17.2)	Max. 1 000					
		LQ104V1LG61				246.5 × 179.4 × 13.7						
		LQ104V1DW02				246.5 × 179.4 × 15.5						
STN	8.9" (22cm)	LM089HB1T04	640 × 240	0.330 × 0.330	Blue and white	250	8 bit parallel	2.3	258.8 × 109.8 × 10.0	320		
TFT	8.5" (22cm)	☆LQ085Y3DG03	800 × RGB × 480	0.231 × 0.231	260 k	(Min. 130)	Digital 6 bit RGB	TBD	222.7 × 135.4 × 12.5	TBD	1CCFT	Wide
		☆LQ085Y3DG04				(250)			(212.0 × 134.0 × 12.5)			
STN		LM085YB1T01	800 × 480		Black and white	200	8 bit parallel	2.4	222.7 × 134.0 × 68.5	300		Wide
TFT	8.4" (21cm)	☆LQ084S3DG01	800 × RGB × 600	0.213 × 0.213	260 k	350	Digital 6 bit RGB	3.7	199.5 × 149.5 × 11.6	Max. 405	2CCFT	Strong LCD2
		☆LQ084S3LG01	800 × RGB × 600		16 M	(400)	LVDS 6 bit + 2FRC RGB		TBD			
		☆LQ084V3DG01	640 × RGB × 480	0.270 × 0.270	260 k	400	Digital 6 bit RGB	5.5	216.0 × 152.4 × 12.0	Max. 430		
		LQ084V1DG21		0.267 × 0.270		300						
STN	8.1" (21cm)	LM081HB1T01B	640 × 240	0.300 × 0.300	Black and white	150	4 bit parallel	1.6	249.0 × 99.4 × 8.5	260		
	7.7" (20cm)	LM077VS1T01	640 × RGB × 480	0.246 × 0.246	– (C-STN)	150	8 bit parallel	2.5	195.2 × 137.5 × 8.0	TBD	2CCFT	
7.5" (19cm)	☆LQ075V3DG01	0.237 × 0.237		260 k	400	Digital 6 bit RGB	5.7	179.0 × 139.5 × 12.7	1CCFT		Strong LCD2	
TFT	6.4" (16cm)	LQ064V3DG01	640 × RGB × 480	0.204 × 0.204	260 k	350	Digital 6 bit RGB	4.7	161.3 × 117.0 × 12.0	Max. 280	2CCFT	Best viewing angle: 3 o'clock direction Ideal for vertical use
		LQ064V3DG04				290						
STN	5.7" (14cm)	☆LQ057V3DG01	640 × RGB × 480	0.180 × 0.180	260 k	(430)	Digital 6 bit RGB	TBD	144.0 × 104.6 × 12.3	TBD		Strong LCD2
		LQ057Q3DC12	320 × RGB × 240	0.360 × 0.360		500			3.9			
STN	4.6" (12cm)	LM32019T	320 × 240	0.36 × 0.36	Blue and white	70	4 bit parallel	1.2	166.0 × 109.0 × 7.5	160	1CCFT	
		LM32019P			Black and white	100						
TFT	5.0" (13cm)	LQ050Q5DR01	320 × RGB × 240	0.3165 × 0.3115	260 k	380	Digital 6 bit RGB	4.2	119.4 × 89.1 × 12.7	Max. 170		
STN		LM050QC1T01		0.315 × 0.315	– (C-STN)	100	8 bit parallel	1.7	134.0 × 100.0 × 8.5			
STN	4.6" (12cm)	LM046QB1S02	320 × 240	0.295 × 0.295	Black and white	100	4 bit parallel	0.9	134.0 × 100.0 × 8.5	140	1CCFT	
TFT	3.8" (10cm)	LQ038Q3DC01	320 × RGB × 240	0.240 × 0.240	260 k	240	Digital 6 bit RGB	0.7	90.6 × 79.9 × 9.9	Max. 105	LED	LED backlight
	3.5" (9cm)	☆LQ035Q3DG01		0.2205 × 0.2205		TBD		TBD	76.9 × 63.9 × TBD		TBD	LED

**Notice**

In the absence of confirmation by device specification sheets, SHARP takes no responsibility for any defects that may occur in equipment using any SHARP devices shown in catalogs, data books, etc. The models listed on this page are lead-free solder compatible. For details, please inquire with SHARP. Contact SHARP in order to obtain the latest device specification sheets before using any SHARP device.



☆New product  
★Under development

<For Information display>

	Display size (cm) ["]	Model No.	Number of pixels*1	Dot format H × V (dot)	Active area H × V (mm)	Number of colors (color)	Outline dimensions*2 W × H × D (TYP.) (mm)	Backlight	Video interface (Input video signal)	Remarks
TFT	163.8 [65]	LK645D3LZ2U	2 073 600	1 080 × 1 920 × RGB	803.52 × 1 428.48	16.77M	907.0 × 1 555.3 × 100.0	Built-in	LVDS*3 (8-bit digital)	Portrait Advanced Super View LCD High luminance: 450cd/m <sup>2</sup> Wide viewing angle: L/R 176°/ U/D 176° High contrast: 2 000:1 High-speed response [G to G]: 6ms (Ave.)
		LK645D3LZ29		1 920 × RGB × 1 080	1 428.48 × 803.52		1 555.3 × 907.0 × 100.0			Advanced Super View LCD High luminance: 450cd/m <sup>2</sup> Wide viewing angle: L/R 176°/ U/D 176° High contrast: 2 000:1 High-speed response [G to G]: 6ms (Ave.)
	132.1 [52]	LK520D3LZ19		1 920 × RGB × 1 080	1 152.0 × 648.0		1 219.0 × 706.7 × 69.8			Advanced Super View LCD High luminance: 450cd/m <sup>2</sup> Wide viewing angle: L/R 176°/ U/D 176° High contrast: 1 800:1 High-speed response [G to G]: 6ms (Ave.)
	116.8 [46]	LK460D3LZ19		1 920 × RGB × 1 080	1 018.0 × 573.0		1 083.0 × 627.0 × 65.7			Advanced Super View LCD High luminance: 450cd/m <sup>2</sup> Wide viewing angle: L/R 176°/ U/D 176° High contrast: 1 800:1 High-speed response [G to G]: 6ms (Ave.)

\*1 Pixel means a set of each RGB dot.

\*2 Excluding FPC for connection and other excessing parts.

\*3 LVDS: Low Voltage Differential Signaling

(Note) Please note that the specifications are subject to change without prior notice for production improvement.

<For LCD TV>

	Display size (cm) ["]	Model No.	Number of pixels*1	Dot format H × V (dot)	Active area H × V (mm)	Number of colors (color)	Outline dimensions*2 W × H × D (TYP.) (mm)	Backlight	Video interface (Input video signal)	Remarks
TFT	132.1 [52]	LK520D3LZxx	2 073 600	1 920 × RGB × 1 080	1 152 × 648	16.77M	(1 219 × 706.7 × 69.8)	Built-in	LVDS*3 (8-bit digital)	Advanced Super View LCD High luminance: 450cd/m <sup>2</sup> Wide viewing angle: L/R 176°/ U/D 176° High contrast: (1 500:1) 120Hz drive compatible
	116.8 [46]	LK460D3LZxx	2 073 600	1 920 × RGB × 1 080	1 018 × 573		(1 083 × 627 × 65.7)			Advanced Super View LCD High luminance: 500cd/m <sup>2</sup> Wide viewing angle: L/R 176°/ U/D 176° High contrast: (1 500:1) 120Hz drive compatible

\*1 Pixel means a set of each RGB dot.

\*2 Excluding FPC for connection and other excessing parts.

\*3 LVDS: Low Voltage Differential Signaling

(Note) Please note that the specifications are subject to change without prior notice for production improvement.

**Notice**

In the absence of confirmation by device specification sheets, SHARP takes no responsibility for any defects that may occur in equipment using any SHARP devices shown in catalogs, data books, etc. The models listed on this page are lead-free solder compatible. For details, please inquire with SHARP. Contact SHARP in order to obtain the latest device specification sheets before using any SHARP device.

## <For automotive applications> (1)

- LQ065T9DZ03/LQ088H9DZ03: operating temperature (panel surface temperature) –40 to +85°C / storage temperature –40 to +95°C
- LQ070Y5DG06/LQ080Y5DG03: operating temperature (panel surface temperature) –30 to 85°C / storage temperature –40 to 95°C
- Other models: operating temperature (panel surface temperature) –30 to 85°C / storage temperature –40 to +85°C

	Display size (cm) ["]	Model No.	Dot format H × V (dot)	Pixel pitch H × V (mm)	Active area H × V (mm)	Input signal system	Input video signal	Backlight	Luminance (cd/m <sup>2</sup> ) (TYP.)	Power consumption (mW) (TYP.)	Outline dimensions*10 W × H × D (mm) (TYP.)	Weight (g) (TYP.)	Remarks
TFT	7.8 [3.1]	LQ031B5DG01	270 × RGB × 96*1	0.273 × 0.273	73.7 × 26.2	6-bit digital RGB	6-bit digital	Built-in LED	350	700	85.4 × 38.8 × 8.65	44	"Compact LCD" suitable for display in meter, Wide screen (8 : 3), LED backlight, 260K-color display, Wide viewing angle, RoHS compliant
	8.3 [3.3]	LQ033B5DG02	160 × RGB × 176*2	0.351 × 0.349	56.2 × 61.4	6-bit digital RGB	6-bit digital	Built-in 1CCFT	290	1 800	73 × 78.3 × 12.5	90	"Compact LCD" suitable for display in meter, High-speed response (low temperature), 260K-color display, Wide viewing angle, RoHS compliant
	8.9 [3.5]	★LQ035Q5DG02	320 × RGB × 240*3	0.222 × 0.222	71.0 × 53.3	6-bit digital RGB	6-bit digital	Built-in LED	500	TBD	86.4 × 84 × 6.7	TBD	"Compact LCD" suitable for display in meter, LED backlight, High luminance, Thin, High-speed response (low temperature), 260K-color display, Wide viewing angle, RoHS compliant
	15 [6.1]	☆LQ061T5GG01	480 × RGB × 234*4	0.284 × 0.308	136.1 × 72.0	NTSC/PAL*11	TFT specific analog RGB*12	Built-in 1CCFT	500	3 200	149 × 82.9 × 7.2	160 (Max.)	Wide QVGA (17:9), Thin, High luminance, Wide viewing angle, RoHS compliant
	16 [6.5]	LQ065T5GG61	400 × RGB × 234*5	0.359 × 0.339	143.4 × 79.3	NTSC/PAL*11	TFT specific analog RGB*12	Built-in 1CCFT	400	3 300	155 × 89.2 × 8.8	175 (Max.)	Wide QVGA (16:9), Thin, Wide viewing angle, RoHS compliant
		☆LQ065T5DG02	400 × RGB × 240*6	0.359 × 0.331	143.4 × 79.3	6-bit digital RGB	6-bit digital	Built-in 1CCFT	620	4 100	155 × 89.2 × 9.1	170	Wide QVGA (16:9), Digital I/F, 260K-color display, High luminance, Wide viewing angle, RoHS compliant
☆LQ065T9DZ03		400 × RGB × 240*6	0.359 × 0.331	143.4 × 79.3	6-bit digital RGB	6-bit digital	Built-in 1CCFT	250	5 200	155 × 89.2 × 12.5	205 (Max.)	"Super Mobile LCD" with high visibility under bright ambient light, Wide QVGA (16:9), Wide viewing angle, Gray-scale inversion free, 260K-color display, RoHS compliant	

\*1 Number of pixels: 25 920

\*4 Number of pixels: 112 320

\*7 Number of pixels: 384 000

\*10 Excluding FPC for connection and other protruding parts.

\*11 MBK-PAL system is adopted as PAL. The LCD panel has 234 (240) scanning lines, and displays a picture of 273 (274) virtual scanning lines.

\*12 Video interface: External (Device specific external video interface IC is available.)

(Note) Please refer to the latest relevant specification sheets before using these devices.

\*2 Number of pixels: 28 160

\*5 Number of pixels: 93 600

\*8 Number of pixels: 115 200

\*3 Number of pixels: 76 800

\*6 Number of pixels: 96 000

\*9 Number of pixels: 153 600

### Notice

In the absence of confirmation by device specification sheets, SHARP takes no responsibility for any defects that may occur in equipment using any SHARP devices shown in catalogs, data books, etc. The models listed on this page are lead-free solder compatible. For details, please inquire with SHARP. Contact SHARP in order to obtain the latest device specification sheets before using any SHARP device.

☆New product  
★Under development

### <For automotive applications> (2)

- LQ065T9DZ03/LQ088H9DZ03: operating temperature (panel surface temperature) -40 to +85°C / storage temperature -40 to +95°C
- LQ070Y5DG06/LQ080Y5DG03: operating temperature (panel surface temperature) -30 to 85°C / storage temperature -40 to 95°C
- Other models: operating temperature (panel surface temperature) -30 to 85°C / storage temperature -40 to +85°C

Display size (cm) ["]	Model No.	Dot format H × V (dot)	Pixel pitch H × V (mm)	Active area H × V (mm)	Input signal system	Input video signal	Back-light	Luminance (cd/m <sup>2</sup> ) (TYP.)	Power consumption (mW) (TYP.)	Outline dimensions*10 W × H × D (mm) (TYP.)	Weight (g) (TYP.)	Remarks
18 [7]	LQ070T5GG21	480 × RGB × 234*4	0.326 × 0.352	156.2 × 82.4	NTSC/PAL*11	TFT specific analog RGB*12	Built-in 1CCFT	500	3 500	167 × 93 × 6.9	195 (Max.)	Wide QVGA (17:9), Thin, High luminance, Wide viewing angle, RoHS compliant
	★LQ070T5DR05	480 × RGB × 240*8	0.321 × 0.363	154.1 × 87.0	6-bit digital RGB	6-bit digital	Built-in 2CCFT	400	5 100	170.1 × 103.4 × 14.2	280 (Max)	Wide QVGA (16:9), Digital I/F, 260K-color display, Wide viewing angle
	LQ070Y5DG05	800 × RGB × 480*7	0.195 × 0.1725	156.0 × 82.8	6-bit digital RGB	6-bit digital	Built-in 1CCFT	460	3 600	167 × 93 × 7.2	196 (Max.)	High resolution (wide VGA/17:9), Thin, W-QVGA (GG21) vertical/horizontal compatible, 260K-color display, Wide viewing angle, RoHS compliant
	★LQ070Y5DG06	800 × RGB × 480*7	0.191 × 0.191	152.4 × 91.4	6-bit digital RGB	6-bit digital	Built-in LED	430*	TBD	170 × 104 × 8.0	TBD	High resolution (wide VGA/15:9), High color purity (65% of NTSC), High-speed response (low temperature), LED backlight, Thin, 260K-color display, Wide viewing angle, RoHS compliant, * Luminosity at eye point
	LQ070Y5DE02	800 × RGB × 480*7	0.195 × 0.1725	156.0 × 82.8	6-bit digital RGB	6-bit digital	Built-in LED	320*	5 250	167.5 × 93.2 × 6.5 to 9.0	215 (Max.)	Dual directional viewing LCD, Wide screen (17:9), LED backlight, Thin, 260K-color display, Wide viewing angle, RoHS compliant, * DV luminosity at eye point
20 [8]	★LQ080Y5DG03	800 × RGB × 480*7	0.2175 × 0.2175	174.0 × 104.4	6-bit digital RGB	6-bit digital	Built-in LED	430*	TBD	190 × 120 × 8.0	TBD	High resolution (wide VGA/15:9), High color purity (65% of NTSC), High-speed response (low temperature), LED backlight, Thin, 260K-color display, Wide viewing angle, RoHS compliant, * Luminosity at eye point
	☆LQ080Y5DG04	800 × RGB × 480*7	0.2175 × 0.2175	174.0 × 104.4	6-bit digital RGB	6-bit digital	Built-in 2CCFT	625	5 900	190 × 120 × 13	392	High resolution (wide VGA/15:9), High-speed response (low temperature), High luminosity, 260K-color display, Wide viewing angle
	★LQ080Y5CGXX	800 × RGB × 480*7	0.222 × 0.207	177.6 × 99.4	NTSC/PAL/PAL (60)	Composite	Built-in 1CCFT	400	10 400	198 × 117 × 17.9	391	High resolution (wide VGA/16:9), All-in-one, Wide viewing angle, RoHS compliant
22 [8.8]	☆LQ088H9DZ03	640 × RGB × 240*9	0.327 × 0.327	209.3 × 78.5	6-bit digital RGB	6-bit digital	Built-in 2CCFT	250	7 100	231.6 × 103.25 × 14.4	370 (Max.)	"Super Mobile LCD" with high visibility under bright ambient light, Wide screen (8:3), Wide viewing angle, Gray-scale inversion free, 260K-color display, RoHS compliant

\*1 Number of pixels: 25 920

\*4 Number of pixels: 112 320

\*7 Number of pixels: 384 000

\*10 Excluding FPC for connection and other protruding parts.

\*11 MBK-PAL system is adopted as PAL. The LCD panel has 234 (240) scanning lines, and displays a picture of 273 (274) virtual scanning lines.

\*12 Video interface: External (Device specific external video interface IC is available.)

(Note) Please refer to the latest relevant specification sheets before using these devices.

The Tenri site NF3 (JQA-AU0121-1) and plants No. 1 and No. 2 (JQA-AU0121-2) at the Mie site of the Mobile Liquid Crystal Display Group have been certified under the ISO/TS 16949:2002 Quality Management System. [Certifying organization: Japan Quality Assurance Organization (JQA)]

#### Notice

In the absence of confirmation by device specification sheets, SHARP takes no responsibility for any defects that may occur in equipment using any SHARP devices shown in catalogs, data books, etc. The models listed on this page are lead-free solder compatible. For details, please inquire with SHARP. Contact SHARP in order to obtain the latest device specification sheets before using any SHARP device.



☆New product  
★Under development

## <For personal AV>

	Display size (cm) ["]	Model No.	Dot format H × V (dot)	Pixel pitch H × V (mm)	Active area H × V (mm)	Input signal system	Input video signal	Back-light	Luminance (cd/m <sup>2</sup> ) (TYP.)	Power consumption (mW) (TYP.)	Outline dimensions* <sup>5</sup> W × H × D (mm) (TYP.)	Weight (g) (TYP.)	Remarks
CG Silicon	6.4 [2.5]	☆LS025A8DZ01	960 × 240* <sup>1</sup>	0.052 × 0.156 (Dot pitch)	49.9 × 37.4	NTSC/PAL* <sup>3</sup>	8-bit digital RGB	Built-in LED	250	230	56.2 × 47.8 × 2.7	21	Super Mobile LCD with high outdoor visibility due to transfectivity, Top/bottom and left/right angle of view 160°, Delta configuration, High contrast, Low power consumption
	6.8 [2.7]	LS027T3DG01		0.062 × 0.139	59.49 × 33.48				250	220	65 × 45 × 2.5	13	
TFT	6.4 [2.5]	★LQ025A3DS01	480 × RGB × 240* <sup>2</sup>	0.104 × 0.156	49.87 × 37.44				250	180	60.0 × 44.3 × 2.7	14	

\*1 Number of Pixels: 230 400

\*2 Number of Pixels: 115 200

\*3 MBK-PAL system is adopted as PAL. The LCD panel has 234 (220) scanning lines, and displays a picture of 273 (256) virtual scanning lines.

\*4 Video interface: Internal

\*5 Excluding FPC for connection and other excessing parts.

\* CG Silicon ... Continuous grain silicon technology developed jointly with Semiconductor Energy Laboratory Co. Ltd. is used.

(Note) Please refer to the latest relevant specification sheets before using these devices.

## <For mobile phones>

	Display size (cm) ["]	Model No.	Dot format H × V (dot)	Pixel pitch H × V (mm)	Active area H × V (mm)	Input video signal	Back-light	Contrast ratio (Transmissive/ Reflective)	Luminance (cd/m <sup>2</sup> ) (TYP.)	Outline dimensions* <sup>4</sup> W × H × D (mm) (TYP.)	Weight (g) (TYP.)	Remarks
CG Silicon	5.6 [2.2]	★LS022Q8UX05	240 × RGB × 320* <sup>1</sup>	0.1395 × 0.1395	33.48 × 44.64	16-bit parallel CPU	Built-in LED	400 : 1 (Transmissive)/ 10 : 1 (Reflective)	300	39.2 × 58.35 × 2.3	T.B.D.	Super Mobile LCD with high outdoor visibility due to transfectivity, Top/bottom and left/right angle of view 160° (CR ≥ 5), High contrast, 260k-color display, RoHS compliant
	7.0 [2.75]	LS028B7UX01	240 × RGB × 400	0.05 × 0.15	36.0 × 60.0	CPU bus		400 : 1	250	41.8 × 70.5 × 2.3	10	

\*1 Number of Pixels: 76 800

\*2 Number of Pixels: 20 480

\*3 Number of Pixels: 16 384

\*4 Excluding FPC for connection and other excessing parts.

\* CG Silicon ... Continuous grain silicon technology developed jointly with Semiconductor Energy Laboratory Co. Ltd. is used.

(Note) Please refer to the latest relevant specification sheets before using these devices.

### Notice

In the absence of confirmation by device specification sheets, SHARP takes no responsibility for any defects that may occur in equipment using any SHARP devices shown in catalogs, data books, etc. The models listed on this page are lead-free solder compatible. For details, please inquire with SHARP. Contact SHARP in order to obtain the latest device specification sheets before using any SHARP device.



■ EL Display Modules

Display size (cm) ["]	Model No.	Dot format H × V (dot)	Dot pitch H × V (mm)	Active area H × V (mm)	Areal luminance (cd/m <sup>2</sup> ) (TYP.)	Supply voltage (V)	Power consumption (W) (TYP.)	Operating temperature (°C)	Outline dimensions*2 W × H × D (mm) (TYP.)	Weight (g) (TYP.)	Remarks
23 [8.9]	LJ64H034	640 × 400	0.30 × 0.30	191.9 × 119.9	110*1	+5, +12	11	-5 to +55	246.0 × 175.0 × 19.0	450	High luminance, Wide viewing angle
	LJ089MB2S01				60				246.0 × 158.0 × 26.0	390	Wide viewing angle

\*1 In case of frame frequency = 120 Hz

\*2 Excluding FPC for connection and other excessing parts.

(Note) Please refer to the latest relevant specification sheets before using these devices.



**Notice**  
 In the absence of confirmation by device specification sheets, SHARP takes no responsibility for any defects that may occur in equipment using any SHARP devices shown in catalogs, data books, etc. The models listed on this page are lead-free solder compatible. For details, please inquire with SHARP. Contact SHARP in order to obtain the latest device specification sheets before using any SHARP device.

## ■ CMOS Camera Modules

Module configuration : CMOS image sensor, CDS/AGC/10-bit ADC, timing generator, DSP, lens (for UXGA/SXGA/VGA)

CMOS image sensor, CDS/AGC/8-bit ADC, timing generator, DSP, lens (for CIF)

Color filter : R, G, B primary color mosaic filters

Operating temperature : -20 to 60°C

Optical format	Image format	Optical function	Model No.	Features	Output pixels (H x V) MAX.	Lens			Output signal	Supply voltage (V)	Power consumption (mW) TYP.	Package*1
						F No.	Con-figuration	Horizontal viewing angle (°)				
1/3.2 type	UXGA	Macro function	LZ0P3955	<ul style="list-style-type: none"> <li>UXGA to SubQCIF</li> <li>10 fps at UXGA/ 30 fps at SVGA</li> <li>5x electronic zoom at QVGA size (MAX.)</li> <li>Image inversion function (right and left)</li> </ul>	1 600 x 1 200	F3.4	3 pcs.	53	UYVY	2.8/1.8 (I/O : 1.8 or 2.8)	290 (at 7.5 fps)	28LCC type
			LZ0P39AG			240 (at 7.5 fps)						24LCC type
1/4 type	UXGA	-	LZ0P395V	<ul style="list-style-type: none"> <li>UXGA to SubQCIF</li> <li>15 fps at UXGA/ 30 fps at SVGA</li> <li>5x electronic zoom at QVGA size (MAX.)</li> <li>Image inversion function (right and left)</li> </ul>	1 280 x 1 024	F2.8	3 pcs.	56	UYVY	2.8/1.8 (I/O : 1.8 or 2.8)	200 (at 15 fps)	30FPC type*2
			LZ0P39DS			220 (at 15 fps)						24LCC type
1/6 type	VGA	-	LZ0P393D	<ul style="list-style-type: none"> <li>SXGA to SubQCIF</li> <li>15 fps at SXGA/ 30 fps at 640 x 512</li> <li>4.2x electronic zoom at QVGA size (MAX.)</li> <li>Image inversion function (right and left)</li> </ul>	640 x 480	F3.2	2 pcs.	54	UYVY	2.8/1.8 (I/O : 1.8 or 2.8)	110 (at 30 fps)	24LCC type
			LZ0P393M			F3.4						
1/7 type	CIF	-	LZ0P394K	<ul style="list-style-type: none"> <li>VGA to SubQCIF</li> <li>30 fps at VGA</li> <li>2x electronic zoom at QVGA size (MAX.)</li> <li>Image inversion function (right and left)</li> </ul>	352 x 288	F2.8	Single	58	UYVY	2.5 (I/O : 2.8)	35 (at 15 fps)	24LCC type
			LZ0P399A									
1/7 type	CIF	-	LZ0P392N	<ul style="list-style-type: none"> <li>CIF/QCIF</li> <li>30 fps at CIF</li> <li>Image inversion function (right and left)</li> </ul>	352 x 288	F2.8	2 pcs.	52	UYVY	2.5 (I/O : 2.8)	35 (at 15 fps)	24LCC type
			LZ0P396K									

\*1 Contact a SHARP sales office regarding socket availability. \*2 Contact a SHARP sales office regarding FPC type package.

CMOS Image Sensors/CCDs

## ● Outline Dimensions

Model No.	Outline dimensions (mm) TYP.	Package*1
LZ0P3955	9.5 x 9.5 x (H) 7.0	28LCC type
LZ0P39AG	8.0 x 8.0 x (H) 4.8	24LCC type
LZ0P395V	8.0 x 8.0 x (H) 4.4	
LZ0P39DS	8.5 x 8.5 x (H) 5.4	30FPC type*2
LZ0P393D	8.4 x 8.4 x (H) 5.3	24LCC type
LZ0P393M	8.0 x 8.0 x (H) 4.9	
LZ0P394K	6.5 x 6.2 x (H) 4.3	
LZ0P399A	5.8 x 5.8 x (H) 3.7	
LZ0P392N	6.5 x 6.5 x (H) 4.5	
LZ0P396K	6.0 x 6.0 x (H) 3.1	

(H) : Module height

\*1 Contact a SHARP sales office regarding socket availability.

\*2 Contact a SHARP sales office regarding FPC type package.

## ● System Configuration Example

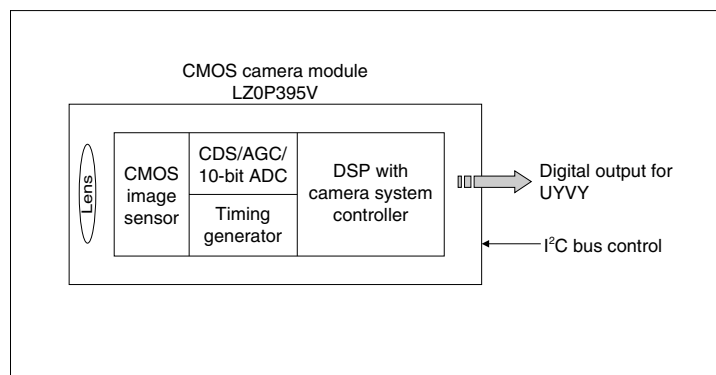



**Higher-resolution CCDs**

Optical format	Total pixels	Color filter	Model No.	30 fps VGA movie	Resolution		Pixel size H x V (μm <sup>2</sup> )	Sensitivity (mV) TYP.	Smear ratio (dB) TYP.	Package
					Image pixels (H x V)					
1/1.7 type	10 540 k	R,G,B primary color mosaic filters	RJ21W3BB0ET	○	3 704 x 2 784	2.05 x 2.05	2.05 x 2.05	100		P-SOP032-0525
			RJ21W3BC0ET	(25 fps VGA movie)						
	12 520 k		RJ21Y3BA0ET	○	4 040 x 3 032	1.88 x 1.88	105			
			RJ21V3BC0ET	(22 fps VGA movie)	3 320 x 2 496					
1/1.8 type	8 500 k		RJ23S3BD0ET	○	2 600 x 1 944	2.2 x 2.2	130	-88	P-SOP028-0400	
1/2.5 type	5 190 k		RJ23S3CD0ET	-						
			RJ23S3BE0BT	○						
			RJ23S3CE0BT	-						
			RJ23T3BB0ET	○	2 872 x 2 160	2.05 x 2.05	100			
	RJ23T3CB0ET		-							
	RJ23T3BC0BT	○								
	6 360 k	7 400 k	RJ23T3CC0BT	-	3 096 x 2 328	1.9 x 1.9	95	-83		
RJ23U3BA0ET			○							
RJ23U3CA0ET			-	105			-88			
RJ23U3BC0BT			○							
RJ23U3CC0BT			-							
8 500 k		RJ23V3BA0BT	○	3 320 x 2 496	1.75 x 1.75	100	-85			
		RJ23V3CA0BT	-							

**1/3-type CCDs**

Total pixels	Standard	Model No.	Resolution		Pixel size H x V (μm <sup>2</sup> )	Sensitivity (mV) TYP.	Smear ratio (dB) TYP.	Package	
			Horizontal TV lines	Image pixels (H x V)					
270 k	Color	RJ2311AA0PB	330	512 x 492	9.6 x 7.5	1 300	-120	P-DIP016-0500C	
		RJ2311BA0PB				2 000	-130		
320 k		PAL		RJ2321AA0PB	512 x 582	9.6 x 6.3	1 300		-120
				RJ2321BA0PB			9.6 x 6.34		2 000
410 k	Color	RJ2351AA0BB	480	768 x 494	6.4 x 7.5	800	-105	N-DIP016-0450	
		RJ2351BA0AB				1 500	-120		
470 k		PAL		RJ2361AA0BB	752 x 582	6.5 x 6.3	750		-105
				RJ2361BA0AB			6.53 x 6.39		1 500

★Under development



## ■ 1/3.8-type CCD

Total pixels	Standard		Model No.	Resolution		Pixel size H x V (μm <sup>2</sup> )	Sensitivity (mV) TYP.	Smear ratio (dB) TYP.	Package
				Horizontal TV lines	Image pixels (H x V)				
290 k	Color	NTSC	★RJ2311AA0PB*	330	532 x 512	7.2 x 5.6	1 200	-120	P-DIP014-0400A

\* Suitable for intense light exposure.

## ■ 1/4-type CCDs

Total pixels	Standard		Model No.	Resolution		Pixel size H x V (μm <sup>2</sup> )	Sensitivity (mV) TYP.	Smear ratio (dB) TYP.	Package		
				Horizontal TV lines	Image pixels (H x V)						
270 k	Color	NTSC	RJ2411AA0PB*	330	512 x 492	7.2 x 5.6	800	-105	P-DIP014-0400A		
			RJ2411AB0PB				1 200	-120			
			RJ2411BA0PB*								
			RJ2411BB0PB								
320 k	Color	PAL	RJ2421AB0PB	512 x 582	7.2 x 4.7	720	-105				
			RJ2421BB0PB		7.2 x 4.73	1 100	-120				
410 k	Color	NTSC	RJ2451AA0PB	480	768 x 494	4.9 x 5.6	400	-90			
			RJ2451BA0PB				600	-114			
470 k		PAL	RJ2461AA0PB				752 x 582	5.0 x 4.7		400	-90
			RJ2461BA0PB					5.0 x 4.77		600	-114

\* Suitable for intense light exposure.

## ■ 1/3-type CCDs with Dual-power-supply (5 V/12 V) Operation\*1

Total pixels	Standard		Model No.	Resolution		Pixel size H x V (μm <sup>2</sup> )	Sensitivity (mV) TYP.	Smear ratio (dB) TYP.	Package
				Horizontal TV lines	Image pixels (H x V)				
270 k	B/W	EIA	LZ2316A3	380	512 x 492	9.6 x 7.5	3 300*2	-110	N-DIP016-0500C
320 k		CCIR	LZ2326A3		512 x 582	9.6 x 6.3	3 000*2		

\*1 With mirror image function

\*2 When IR cut-off filter is not used.

## ■ CCD Peripheral ICs/LSIs

Description	Model No.	Features		Package
Single-chip driver (Timing generator + Synchronous signal generator)	LR385851	For 270-k/320-kpixel CCDs with dual-power-supply operation (5 V/12 V)	Electronic shutter, electronic exposure, mirror image function, for B/W CCDs, level shifter, smooth shutter, line lock function	P-QFP048-0707
Signal processor	IR3Y30M2	Available for signal processing from CCD output to 75 Ω video output, for B/W CCDs, comparator for electronic exposure, high-speed S/H circuit, H aperture, LPF, AGC		P-QFP048-0707
V driver	LR366851	Vertical pulse driver for CCDs, 2-level output x 2, 3-level output x 4, 2-level output circuit for electronic shutter		P-SSOP024-0275
	LR36687U/Y	Vertical pulse driver for CCDs, 2-level output x 10, 3-level output x 10, 2-level output circuit for electronic shutter		P-VQFN064-0808/ TFBGA068-0606
	LR36689U	Vertical pulse driver for CCDs, 2-level output x 4, 3-level output x 8, 2-level output circuit for electronic shutter		P-VQFN036-0505
CDS/PGA/ADC	IR3Y48A3/A5	Low power consumption [80 mW (TYP.) ], high-speed S/H circuit, high-gain PGA circuit, 10-bit ADC (18 MHz), 10-bit digital output		P-QFP048-0707/ P-VQFN052-0707
	★IR3Y48B1	Low power consumption [80 mW (TYP.) ], high-speed S/H circuit, high-gain PGA circuit, 10-bit ADC (18 MHz), 10-bit digital output		P-QFP048-0707
	IR3Y60U6	Low power consumption [69 mW (TYP.) ], high-speed S/H circuit, high-gain PGA circuit, 10-bit ADC (20 MHz), 10-bit digital output		P-VQFN032-0505
	IR3Y50U6	Low power consumption [75 mW (TYP.) ], high-speed S/H circuit, high-gain PGA circuit, 12-bit ADC (25 MHz), 12-bit digital output		P-VQFN036-0606
Timing generator + V driver + CDS/PGA/ADC	LR38667	For 1/2.5-type 5 190-kpixel CCDs with/without movie function	<Timing generator> Monitoring mode/still mode	LFBGA192-1010
	LR38675	For 1/2.5-type 6 360-kpixel CCDs with/without movie function	<V driver> Vertical pulse driver for CCDs, 2-level output x 10, 3-level output x 10, 2-level output circuit for electronic shutter	
	LR38678	For 1/2.5-type 7 400-kpixel CCDs with/without movie function	<CDS/PGA/ADC> 30 MHz (LR38667)/ 36 MHz (LR38675/LR38678/LR38677), high-speed S/H circuit, high-gain PGA circuit, 12-bit ADC, 12-bit digital output	
	LR38677	For 1/1.8-type 8 500-kpixel, 1/1.7-type 10 540-kpixel CCDs with movie function		
	★LR36B11	For 1/2.5-type 5 190-kpixel, 6 360-kpixel, 7 400-kpixel, 8 500-kpixel CCDs with/without movie function, For 1/1.8-type 8 500-kpixel, 1/1.7-type 10 540-kpixel, 12 520-kpixel CCDs with movie function	<Timing generator> Programmable timing generator <V driver> Vertical pulse driver for CCDs, 2-level output x10, 3-level output x10 2-level output circuit for electronic shutter <CDS/PGA/ADC> 40 MHz, high-speed S/H circuit, high-gain PGA circuit, 22-bit ADC, 16-bit digital output	LFBGA140-0909
V driver + CDS/PGA/ADC + DSP	LR386431/33	For 270-k/320-k/410-k/ 470-kpixel CCDs	<V driver> Vertical pulse driver for CCDs, 2-level output x 2, 3-level output x 2, 2-level output circuit for electronic shutter <CDS/PGA/ADC> 18 MHz, high-speed S/H circuit, high-gain PGA circuit, 10-bit ADC <DSP> 9-bit DAC, synchronous signal generation circuit, CCD drive timing generator, AE control function, AWB control function, mirror image function, YUV digital output, NTSC/PAL analog output	LFBGA168-1212/ LFBGA171-0811
	LR38653		<V driver> Vertical pulse driver for CCDs, 2-level output x 2, 3-level output x 2, 2-level output circuit for electronic shutter <CDS/PGA/ADC> 25 MHz, high-speed S/H circuit, high-gain PGA circuit, 12-bit ADC <DSP> 10-bit DAC, synchronous signal generation circuit, CCD drive timing generator, AE control function, AWB control function, lens shading correction function, auto white blemish compensation function, mirror image function, YUV digital output, NTSC/PAL analog output	LFBGA171-0811





## ■ CCD Peripheral ICs/LSIs (cont'd)

Description	Model No.	Features	Package	
V driver + CDS/PGA/ADC + DSP	LR38654	For 270-k/290-k/320-k/410-k/ 470-kpixel CCDs  <V driver> Vertical pulse driver for CCDs, 2-level output x 2, 3-level output x 2, 2-level output circuit for electronic shutter <CDS/PGA/ADC> 25 MHz, high-speed S/H circuit, high-gain PGA circuit, 12-bit ADC <DSP> 10-bit DAC, synchronous signal generation circuit, built-in CCD drive timing generator, AE control function, AWB control function, lens shading correction function, auto white blemish compensation function, mirror image function, electronic optical axis adjustment function*1, YUV digital output, NTSC/PAL analog output	LFBGA171-0811	
DSP	LR386032	For 270-k/320-k/410-k/ 470-kpixel CCDs	9-bit DAC, synchronous signal generation circuit, built-in CCD drive timing generator, AE control function, AWB control function, mirror image function, YUV digital output, NTSC/PAL analog output	P-LQFP080-1212
	LR386071		9-bit DAC, synchronous signal generation circuit, built-in CCD drive timing generator, AE control function, AWB control function, mirror image function, YUV digital output, NTSC/PAL analog output, Y/C separation analog output, line lock function	P-LQFP100-1414
	LR38627		10-bit DAC, synchronous signal generation circuit, built-in CCD drive timing generator, AE control function, AWB control function, lens shading correction function, auto white blemish compensation function, mirror image function, YUV digital output, NTSC/PAL analog output	P-TQFP128-1414
Buffer IC for CCD output circuit	★IR3T47G	For 5 190-kpixel to 12 520-kpixel CCDs	Input voltage range : 11.5 to 16 V, Constant current range : 1 to 5.5 mA, ON/OFF control for constant current	B-VQFN8 (1.50 mm x 1.50 mm)
Power supply IC for CCDs and peripheral ICs/LSIs	IR3M55U*2	For 270-k/320-kpixel CCDs	Input voltage range : 4.5 to 16 V, PWM control + charge pump system, output voltage : three outputs (15 V/12 V, -8 V/-5 V, 3.3 V), power sequencing circuit, overcurrent protection circuit	P-VQFN032-0505
	IR3M59U			
	IR3M61U*2	For 270-k/290-k/320-k/410-k/ 470-kpixel CCDs	Input voltage range : 4.5 to 10 V, PWM control + charge pump system, output voltage : four outputs (15 V, -8 V, 3.3 V, 1.8 V), power sequencing circuit, overcurrent protection circuit	
	IR3M63U			

\*1 Only support for 290-kpixel CCD.

\*2 For in-vehicle use

## ●System Configuration Examples

### • High-resolution Digital Camera System with Three-chip Configuration

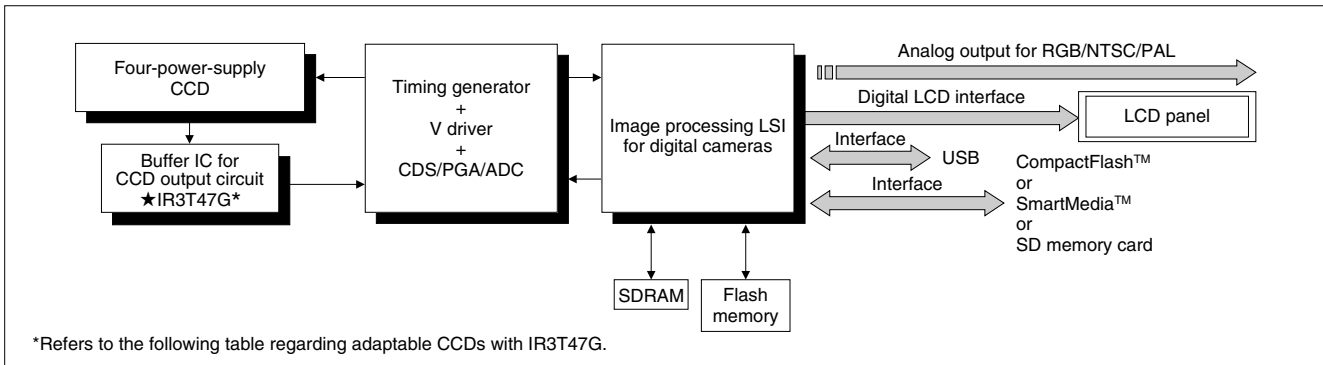

### Four-power-supply CCDs and peripheral IC/LSIs

CCD			30 fps VGA movie	Buffer IC for CCD output circuit	Timing generator + V driver + CDS/PGA/ADC	
1/1.7 type	10 540 k pixels	RJ21W3BB0ET	○ (25 fps VGA movie)	-	LR38677/★LR36B11	
		RJ21W3BC0ET			★IR3T47G	★LR36B11
	12 520 k pixels	RJ21Y3BA0ET	○ (22 fps VGA movie)			
1/1.8 type	8 500 k pixels	RJ21V3BC0ET	○		LR38677/★LR36B11	
1/2.5 type	5 190 k pixels	RJ23S3BD0ET	○	-	LR38667/★LR36B11	
		RJ23S3CD0ET	-			
		RJ23S3BE0BT	○			
		RJ23S3CE0BT	-			
	6 360 k pixels	RJ23T3BB0ET	○	-	-	LR38675/★LR36B11
		RJ23T3CB0ET	-			
		RJ23T3BC0BT	○			
		RJ23T3CC0BT	-			
7 400 k pixels	RJ23U3BA0ET	○	-	-	LR38678/★LR36B11	
	RJ23U3CA0ET	-				
	RJ23U3BC0BT	○				
	RJ23U3CC0BT	-				
8 500 k pixels	RJ23V3BA0BT	○	-	★IR3T47G	★LR36B11	
	RJ23V3CA0BT	-				

• Color Security Camera System with Two-chip Configuration [Low Power Consumption Type]

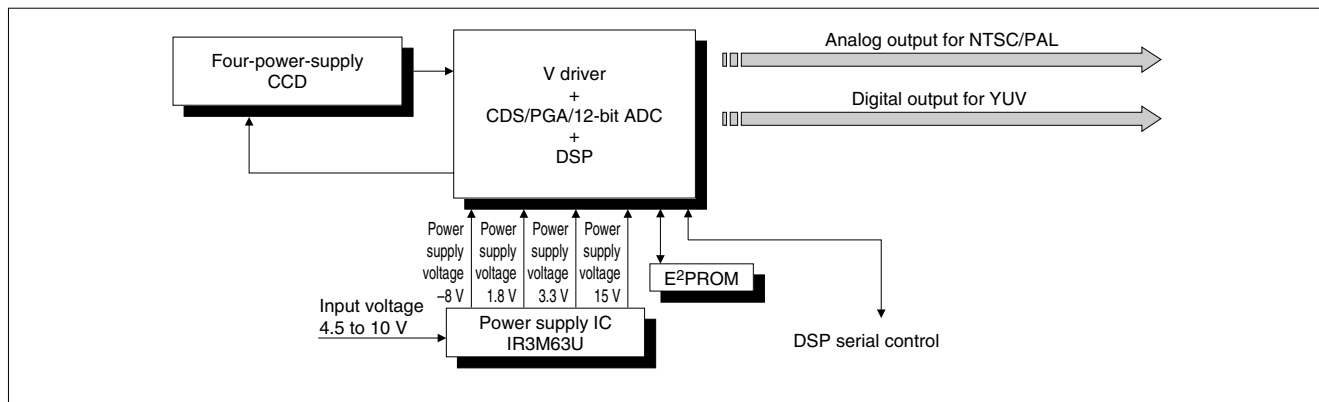

Four-power-supply CCDs and peripheral IC/LSIs

CCD			V driver + CDS/PGA/ADC + DSP	Power supply IC	
1/3 type	270 k pixels	RJ2311AA0PB	LR38653/LR38654	—	
		RJ2311BA0PB			
	320 k pixels	RJ2321AA0PB			
		RJ2321BA0PB			
	410 k pixels	RJ2351AA0BB			IR3M63U
		RJ2351BA0AB			
470 k pixels	RJ2361AA0BB	—			
	RJ2361BA0AB				
1/3.8 type	290 k pixels	★RJ2411CA0PB	LR38654	IR3M63U	
1/4 type	270 k pixels	RJ2411AA0PB	LR38653/LR38654		
		RJ2411AB0PB			
		RJ2411BA0PB			
		RJ2411BB0PB			
	320 k pixels	RJ2421AB0PB			—
		RJ2421BB0PB			
	410 k pixels	RJ2451AA0PB			IR3M63U
		RJ2451BA0PB			
	470 k pixels	RJ2461AA0PB			—
		RJ2461BA0PB			



• Color Security Camera System with Two-chip Configuration

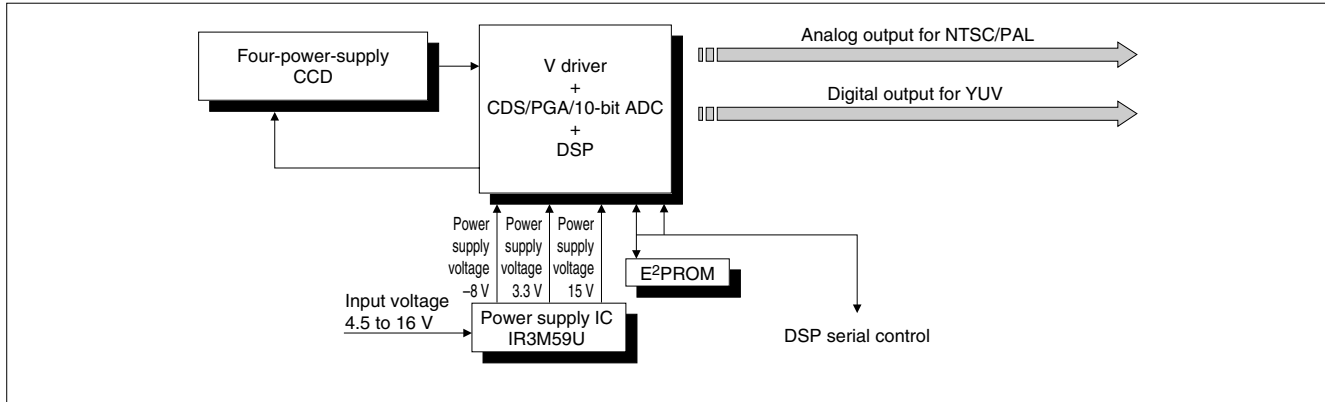

Four-power-supply CCDs and peripheral IC/LSIs

CCD		V driver + CDS/PGA/ADC + DSP	Power supply IC
1/3 type	270 k pixels	RJ2311AA0PB	—
		RJ2311BA0PB	
	320 k pixels	RJ2321AA0PB	
		RJ2321BA0PB	
	410 k pixels	RJ2351AA0BB	
		RJ2351BA0AB	
470 k pixels	RJ2361AA0BB		
	RJ2361BA0AB		
1/4 type	270 k pixels	RJ2411AA0PB	IR3M59U
		RJ2411AB0PB	
		RJ2411BA0PB	
		RJ2411BB0PB	
	320 k pixels	RJ2421AB0PB	
		RJ2421BB0PB	
	410 k pixels	RJ2451AA0PB	
		RJ2451BA0PB	
	470 k pixels	RJ2461AA0PB	
		RJ2461BA0PB	

## • Color Security Camera System with Four-chip Configuration

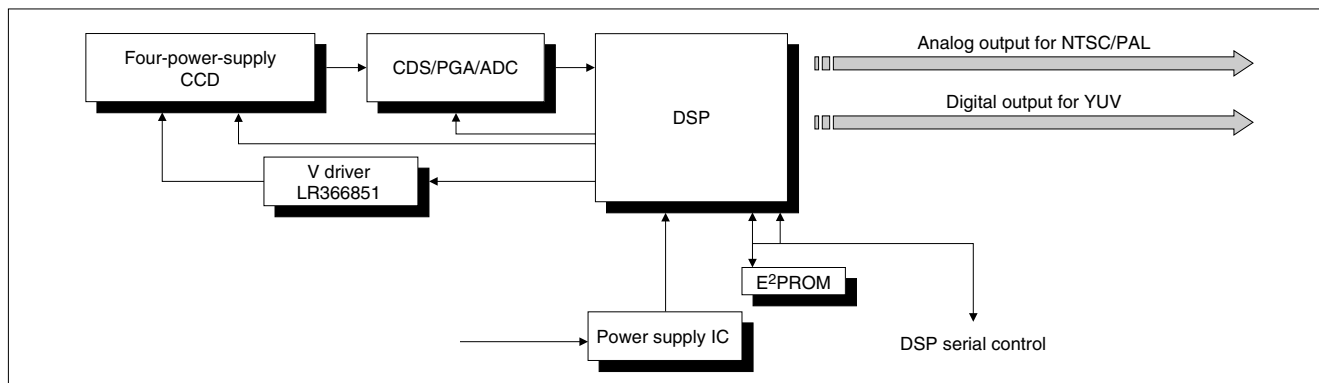

### Four-power-supply CCDs and peripheral ICs/LSIs (1)

CCD		V driver	CDS/PGA/ADC	DSP	Power supply IC
1/3 type	270 k pixels	RJ2311AA0PB	—	—	—
		RJ2311BA0PB			
	320 k pixels	RJ2321AA0PB			
		RJ2321BA0PB			
	410 k pixels	RJ2351AA0BB			
		RJ2351BA0AB			
470 k pixels	RJ2361AA0BB				
	RJ2361BA0AB				
1/4 type	270 k pixels	RJ2411AB0PB	LR366851	IR3Y60U6 + LR386071, IR3Y48A3/A5/B1* + LR386032, IR3Y48A3/A5/B1* + LR386071	IR3M59U
		RJ2411BB0PB			
	320 k pixels	RJ2421AB0PB			
		RJ2421BB0PB			
	410 k pixels	RJ2451AA0PB			
		RJ2451BA0PB			
	470 k pixels	RJ2461AA0PB			
		RJ2461BA0PB			
					—





**Four-power-supply CCDs and peripheral ICs/LSIs (2)**

CCD			V driver	CDS/PGA/ADC	DSP	Power supply IC
1/3 type	270 k pixels	RJ2311AA0PB	LR366851	IR3Y50U6	LR38627	—
		RJ2311BA0PB				
	320 k pixels	RJ2321AA0PB				
		RJ2321BA0PB				
	410 k pixels	RJ2351AA0BB				
		RJ2351BA0AB				
	470 k pixels	RJ2361AA0BB				
		RJ2361BA0AB				
1/4 type	270 k pixels	RJ2411AB0PB				IR3M63U
		RJ2411BB0PB				
	320 k pixels	RJ2421AB0PB				
		RJ2421BB0PB				
	410 k pixels	RJ2451AA0PB				
		RJ2451BA0PB				
	470 k pixels	RJ2461AA0PB				
		RJ2461BA0PB				
	—	IR3M63U				
	—	IR3M63U				
—	IR3M63U					

**• B/W Security Camera System**

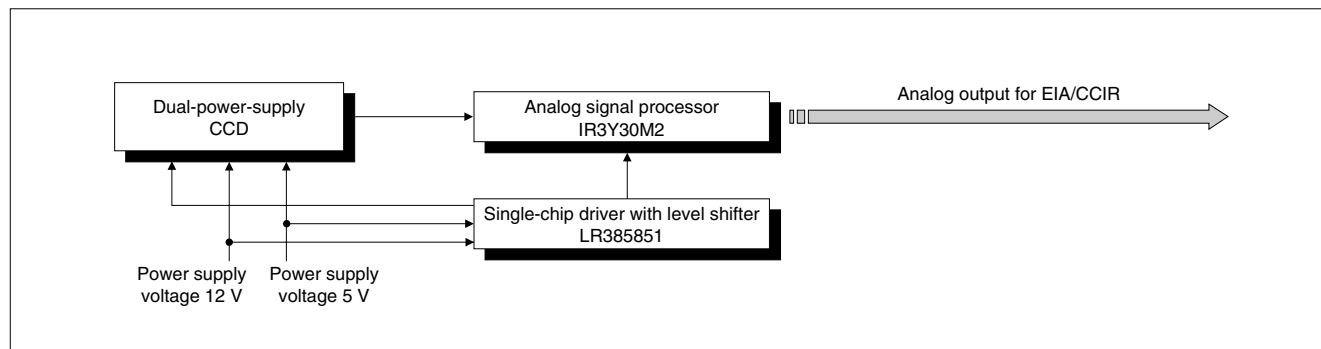

**Dual-power-supply CCDs and peripheral IC/LSI for analog interface**

CCD			Single-chip driver (Timing generator + Synchronous signal generator)	Signal processor
1/3 type	270 k pixels	LZ2316A3	LR385851	IR3Y30M2
	320 k pixels	LZ2326A3		



## ■ For Notebook PCs, PC Monitors and LCD TVs

### ● TFT-LCD Drivers

Drive function		Model No.	Gray scale	No. of LCD drive outputs	Display voltage (V) MAX.	Clock frequency (MHz) MAX.	Supply voltage (V)	Description	Package
Source driver	Dot inversion drive	LH16AM	64 levels	384	13.5	85	2.7 to 3.6	Low EMI*1 driver using RSDS™*2 interface, built-in reference voltage generation circuit, R-DAC system	SOF
		LH16B6		402/414 420/432			2.3 to 3.6		
		LH16AD		480/504/ 516/528			2.7 to 3.6		
		LH16B5		630/642			2.3 to 3.6		
		LH16B9		684/690/ 702/720			2.3 to 3.6		
		LH16AE	256 levels	384	15	2.7 to 3.6			
		LH16BP		384/402/ 408/414/ 420	16.5				
		LH16AW		384/414/ 420	16				
		LH16AF		480	15				
Gate driver		LH1691	-	240	33	0.1	3.0 to 5.5	Selectable 1-pulse (normal) or 2-pulse (continuous/jumping) scanning, usable with both positive/negative power supplies	TCP/SOF/COG
		LH1694		256	42		2.7 to 3.6	Output signal masking function, usable with both positive/negative power supplies, enables chain connection	TCP/SOF
		LH169J		200/240/ 256/263/ 270	45	0.2	2.4 to 4.2	Output signal masking function, enable constructing the module without substrate	SOF

\*1 EMI : Electro-Magnetic Interference

\*2 RSDS™ : Reduced Swing Differential Signaling



## ■ For Mobile Equipment

### ● TFT-LCD Drivers

Drive function		Model No.	Gray scale	No. of LCD drive outputs	Display voltage (V) MAX.	Clock frequency (MHz) MAX.	Supply voltage (V)	Description	Package
Source driver	Dot inversion drive	LH16AV	64 levels	402/480/516	13.5	65	2.7 to 3.6	Built-in reference voltage generation circuit, R-DAC system, power saving function	COG
	Line inversion drive	LH168Y		240	5.5	35	2.5 to 5.5	Built-in reference voltage generation circuit, R-DAC system, power saving function, polarity inversion of input data	
		LH16AR		480			2.5 to 3.6	Built-in R-DAC system, power saving function, polarity inversion of input data	
		LH1687	Analog	240	12.5	3.0 to 5.5	Selectable three-point simultaneous or normal sampling (Sampling frequency : 25 MHz), power saving function, 3 V drive (MIN.), prechargeless output	TCP/SOF/COG	
Gate driver		LH1691	–	240	33	0.1	Selectable 1-pulse (normal) or 2-pulse (continuous/jumping) scanning, usable with both positive/negative power supplies	COG	
		LH169H		240/244/258	40		2.5 to 3.6		Output signal masking function, enables chain connection

### ● STN-LCD Drivers

Drive technology	Drive function	Model No.	No. of LCD drive outputs	Duty ratio	Display voltage (V) MAX.	Data input	Clock frequency (MHz) MAX.	Supply voltage (V)	Package
New drive technology*1	Segment	LH1583	160	to 1/240	+5.5	4/8-bit parallel	12 (at 2.4 V) / 20 (at 5 V)	2.4 to 5.5	TCP/SOF
		LH1580	240	to 1/480		8/12-bit parallel	30 (at 2.5 V) / 55 (at 5 V)	2.5 to 5.5	
	Common	LH1537	200/240	1/200, 1/240	+45	–	3 (at 2.4 V) / 4 (at 5 V)	2.4 to 5.5	
		LH1538	120/128	to 1/480	+80		3 (at 2.5 V) / 4 (at 5 V)		
Conventional drive technology*2	Segment	LH1542	80	to 1/240	+30	4-bit parallel	8	2.5 to 5.5	
		LH1549	160	to 1/480	+42	4/8-bit parallel	12 (at 2.5 V) / 20 (at 5 V)		
		LH1548	240			8/12-bit parallel	12 (at 2.5 V) / 25 (at 5 V)		
	Common (Pin-selectable)	LH1530	120	to 1/480	+42	–	3 (at 2.5 V) / 4 (at 5 V)		
		LH1565	160	to 1/240	+30		4/8-bit parallel (at segment drive)		[Segment mode] 8 [Common mode] 4
		LH1560		to 1/480	+42				[Segment mode] 8 (at 2.5 V) / 14 (at 5 V) [Common mode] 4
LH1562	240				[Segment mode] 12 (at 2.5 V) / 20 (at 5 V) [Common mode] 4				

\*1 New drive technology : A drive technology which drives LCDs with low voltage of 5 V on segment side and drives LCDs with high voltage on common side. Driving with low voltage on segment side enables LCDs to reduce power consumption and shadowing.

\*2 Conventional drive technology : A drive technology which drives LCDs with high voltage on both segment and common sides.

### ● Power Supply IC for STN-LCD Drivers

Model No.	Description	Supply voltage (V)	Package
LR3697A	For STN LCD drivers with new drive technology* DC-DC converter for LCD drive power supply, built-in bias voltage generation circuit for LCD drive, electronic volume control circuit	2.4 to 3.3 (V <sub>DD</sub> , V <sub>P</sub> )	P-QFP072-1010

\* New drive technology : A drive technology which drives LCDs with low voltage of 5 V on segment side and drives LCDs with high voltage on common side. Driving with low voltage on segment side enables LCDs to reduce power consumption and shadowing.



## ■ For Mobile Phones

### ● TFT-LCD Controller/Driver with Two-chip Configuration (LR38825 + LH169C)

Model No.	No. of LCD drive outputs		Display colors MAX.	Display RAM capacity (bit)	a-Si	Function	CPU interface	External image interface	Supply voltage (V)			Package
	Source	Gate							Core	Host I/F	Display	
LR38825	528	—	262 144 colors	240 x 176 x 18	○	<ul style="list-style-type: none"> <li>Versatile graphic functions</li> <li>Window display function</li> <li>Write mask function</li> <li>Bit built function</li> <li>Built-in gray-scale control circuit</li> <li>Built-in timing generator</li> </ul>	80-family (8/16/18-bit parallel, serial)	RGB : respective 6-bit parallel	1.65 to 1.95	1.65 to 3.6	4.75 to 5.25	COG
LH169C	—	240		—	○	<ul style="list-style-type: none"> <li>Built-in DC-DC converter, VCOM generation circuit</li> </ul>	—	—	2.75 to 3.3		26.5 (MAX.)	

### ● Single-chip TFT-LCD Controller/Driver

Model No.	No. of LCD drive outputs		Display colors MAX.	Display RAM capacity (bit)	a-Si	Function	CPU interface	External image interface	Supply voltage (V)			Package
	Source	Gate							Core	Host I/F	Display	
LR38826	396	176	262 144 colors	176 x 132 x 18	○	<ul style="list-style-type: none"> <li>Versatile graphic functions</li> <li>Window display function</li> <li>Write mask function</li> <li>Bit built function</li> <li>Built-in gray-scale control circuit</li> <li>Built-in timing generator, DC-DC converter, VCOM generation circuit</li> </ul>	80-family (8/16/18-bit parallel, serial)	RGB : respective 6-bit parallel, YUV format	1.65 to 1.95	1.65 to 3.6	2.75 to 3.3 (Using built-in power supply ·Source : 4.0 to 5.5 ·Gate : 20 to 27.5)	COG

### ● TFT-LCD Controllers

Model No.	LCD interface (pixel) MAX.	Display colors MAX.	Display RAM capacity (bit)	a-Si	Function	CPU interface	External image interface	Supply voltage (V)		Package
								Core	Host I/F	
LR38822A	176 x 240	65 536 colors	176 x 240 x 16		<ul style="list-style-type: none"> <li>Built-in timing generator, clock generator</li> </ul>	80-family (8/16-bit parallel, serial)	RGB : respective 6-bit parallel	2.25 to 2.75	3.0 to 3.6	TFBGA112-1010
LR388D1	240 x 400	262 144 colors	240 x 400 x 18		<ul style="list-style-type: none"> <li>MDDI* compliant</li> <li>Built-in IrSimple™ and IrDA functions</li> <li>Main/sub LCD controller</li> <li>Graphic processing</li> </ul>	MDDI* for MSM series/ 80-family (8/9/16/18-bit parallel)	—	1.65 to 1.95	1.65 to 3.6	VFBGA144-0808
LR38869A				<ul style="list-style-type: none"> <li>MDDI* compliant</li> <li>Main/sub LCD controller</li> <li>Graphic processing</li> <li>Parallel bus host interface</li> </ul>	TFBGA176-0909					
LR388D0				<ul style="list-style-type: none"> <li>DAC type LCD controller</li> <li>Built-in voltage generation circuit for LCD</li> <li>Built-in common drive circuit</li> <li>Built-in level shifter for panel control</li> <li>Built-in timing generator</li> </ul>	VFBGA144-0808					

\* MDDI (Mobile Display Digital Interface) : The serial interface standard developed by QUALCOMM.

### ● TFT-LCD Driver

Model No.	No. of LCD drive outputs	LTPS*	Function	External image interface	Supply voltage (V)		Package
					Source	Display MAX.	
LH16AP	240	○	<ul style="list-style-type: none"> <li>Built-in timing generator, DC-DC converter, VCOM generation circuit</li> </ul>	RGB : respective 6-bit parallel	2.2 to 3.6	5.5	COG/SOF

\* LTPS : Low Temperature Poly-Silicon



### ●Color STN-LCD Controllers/Drivers

Display colors MAX.	Drive function	Model No	No. of LCD drive outputs		Display RAM capacity (bit)	Duty ratio	Display voltage (V) MAX.	Data input	Clock frequency (MHz) MAX.	Supply voltage (V)	Package
			Segment	Common							
256 colors	Segment and Common	LH15H1	288	66	96 x 66 x 8	1/10, 1/18, 1/26, 1/34, 1/42, 1/50, 1/58, 1/66	+13.2	8/16-bit parallel, serial	4 (at 3 V)	1.8 to 3.3	TCP/SOF
4 096 colors		LH15JA		132	132 x 132 x 12	1/33, 1/39, 1/68, 1/74, 1/133, 1/139	+18	8-bit parallel, serial	3 (at 2.5 V)	1.65 to 3.3	COG
65 536 colors		LH15KA	396	176	132 x 176 x 16	to 1/176 (Selectable per 1 line)	+18.6	8/16-bit parallel, serial	4 (at 3 V)	1.8 to 3.3	COG
262 144 colors		LH15LA		162	132 x 162 x 18	to 1/162 (Selectable per 1 line)	±18		6.25 (at 1.65 to 1.95)	Core : 1.65 to 1.95 Host I/F : 1.65 to 3.6	COG

### ●Color STN-LCD Controller

Model No.	LCD interface (pixel) MAX.	Display colors MAX.	Function/Feature	CPU interface	Display RAM capacity (bit)	Supply voltage (V) TYP.	Package
LR38844A	128 x 164	65 536 colors	<ul style="list-style-type: none"> <li>High-speed host access</li> <li>Display colors selectable : 256/4 096/65 536 colors</li> <li>Power saving function reduces the power consumption in standby mode</li> <li>Built-in CPU interface, LCD interface, clock generator, display memory</li> </ul>	Recommended to be used together with LH15H1	68-family/80-family (8/16 bits)	2.5	TFBGA081-0808





## ■ Peripheral ICs for LSIs for LCDs

### ● Video Interface ICs for TFT-LCDs

Model No.	Input signal				Color decode	LCD panel				Serial data control	Supply voltage (V) TYP.	Power consumption (mW) TYP.	Package
	Composite video	Y/color difference	Analog RGB	OSD (Digital)		± power source	+ power source	Low voltage source	Digital input				
IR3Y18A1	○				NTSC/PAL	○	○				4.5/12 or 4.5/-7.5	130	P-QFP048-0707
IR3Y26A2/A6			○*3		-			○			5/7.5	140	P-QFP048-1010/ P-QFP048-0707
IR3Y29A1/B1	○		○		NTSC/PAL			○				190	
IR3Y31M1	○		○		NTSC/PAL	○	○				4.5/12 or 4.5/-7.5	160	
IR3Y34M1		○	○	○	-		○				3/12	88	
IR3Y37A1		○(Common terminal)		○	-			○			3/6.5	106/88*5	P-QFP048-0707
RB5P0010M2			○*3	○	-	○	○		○	3/12 or 3/4.5/-7.5	92		
RB5P0020M2		○(Common terminal)		○	-			○		3/5	70/57*5		
RB5P0050M2		○(Common terminal)		○	-			○	○			95/80*5	
RB5P0060M2	○		○		NTSC/PAL			○	○	3/5/13		120	P-QFP048-1010
RB5P006AM2	○		○		NTSC/PAL			○	○				
RB5P0070M*1	○		○	○	NTSC/PAL				○	3/7	330		P-QFP072-1010
RB5P0090M	○		○*3		NTSC/PAL (automatic identification)			○	○	5/13	250		P-QFP048-1010
LRS5751*2	○		○		NTSC/PAL			○		3.3/5/7.5	197		P-LQFP100-1414
LRS5752*2	○		○*3		NTSC/PAL (automatic identification)			○	○	3.3/5/13	257		
★IR3Y63M	○	○	○*4	○ (Built-in)	NTSC/PAL/ SECAM			○	○	3.3/5	300		P-TQFP100-1414

\*1 For digital signal input panels

\*2 Built-in timing generator

\*3 Two inputs

\*4 Digital RGB input is also available.

\*5 At analog input for RGB



### ●Power Supply ICs for TFT-LCDs

Model No.	Application/Function	Oscillation frequency (kHz)	Supply voltage (V)	Package
IR3M16U	For small TFT-LCD panels, charge pump system DC-DC converter (15.3 V, 5.1 V, -10.2 V)	100	2.6 to 3.6	P-HQFN020-0404
IR3M30M/U	For small/medium TFT-LCD panels, PWM switching system DC-DC converter (Output voltage (3ch) : External setting)	70 to 1 000	2.7 to 5.5	P-QFP048-0707/ P-VQFN036-0505
IR3M58M/U		70 to 500	4.5 to 28	

### ●Gray-scale ICs for TFT-LCDs

Model No.	Panel type	Function	No. of output circuits	Output current (mA) MAX.	Common output current (mA) MAX.	Supply voltage (V)	Package
IR3E2015	<ul style="list-style-type: none"> <li>• Small panels</li> <li>• Line inversion drive</li> </ul>	$\gamma$ correction, gray-scale voltage generator for LCD drive, built-in dividing resistors	10	$\pm 1$	$\pm 1$	4.5 to 5.5	P-MFP018
IR3E2045			5			4.6 to 5.5	P-SSOP012-0225/ P-HQFN020-0404
IR3E3XX*							
IR3E11P1	<ul style="list-style-type: none"> <li>• Large panels</li> <li>• Up to 20-inch panels</li> <li>• SXGA/UXGA</li> <li>• Dot inversion drive</li> </ul>	$\gamma$ correction, gray-scale voltage generator for LCD drive	10	$\pm 15$	$\pm 150$	7 to 14	P-QFP048-0707
IR3E11A1			7 to 15			P-TQFP048-0707	
IR3E11M1			7 to 14				
IR3E12M1			7 to 15				
IR3E13N/U	<ul style="list-style-type: none"> <li>• Medium/large panels</li> <li>• Dot inversion drive</li> </ul>		6		$\pm 50$	5 to 15	P-MFP018/ P-VQFN020-0404

\* SHARP can offer semi-custom-made gray-scale ICs in accordance with the characteristics of LCD panels.



## Special-function LSIs

Model No.	Function	Features	Supply voltage (V)	Package
LR388D1	WQVGA LCD controller with a built-in IrSimple™ function based on MDDI	<ul style="list-style-type: none"> <li>Built-in video memory : 240 x 400 pixels, 260 k colors (18 bits)</li> <li>MDDI*1 TYPE I compliant</li> <li>Supports 80-family CPU bus (8/9/16/18 bits)</li> <li>Built-in modulation and demodulation IP for IrSimple™, IrDA, and IR remote controller</li> <li>Built-in graphic engine (built-in zoom, scroll functions, etc.)</li> <li>Supports dual displays for both main WQVGA and Sub CPU panels</li> </ul>	Core : 1.8 (TYP.) I/O : 1.8 to 3.3	VFBGA144-0808
LR388B6/B61	Front-end LSI for IrSimple™, IrDA, and IR remote controller	<ul style="list-style-type: none"> <li>Simple function LSI for IrSimple™, IrDA, and IR remote controller</li> <li>Built-in 4 160-byte buffer</li> <li>System proposal with SHARP front-end module</li> </ul>	Core : 1.8 (TYP.) I/O : 1.8 to 3.3	TFBGA056-0808/ VFBGA057-0505
LR388B3	IrSS™ controller with JPEG decoder	<ul style="list-style-type: none"> <li>High-speed 4-Mbps infrared communication</li> <li>IrSimple™ 1.0-compliant one-way communication function</li> <li>Built-in JPEG decoder</li> <li>SDTV and HDTV video outputs</li> </ul>	Core : 1.2 (TYP.) I/O : 3.3 (TYP.)	TFBGA180-1313
LR38888	H. 264 decoder for one-segment digital terrestrial TV broadcasting	<ul style="list-style-type: none"> <li>Built-in video (H. 264) and audio (MPEG2-AAC + SBR) decoding functions</li> <li>Low power consumption : 150 mW</li> <li>Fast play</li> <li>Built-in memory (DRAM)</li> <li>Input signal : MPEG2-TS</li> <li>Image size : QVGA</li> <li>Frame rate : 15 frames/s</li> <li>Output signal format : Image UYVY/RGB for video, I<sup>2</sup>S for audio</li> <li>Output interface : CPU bus, camera interface</li> </ul>	Core : 1.3 (TYP.) I/O : 1.8 / 3.3	TFBGA208-1010
LR35501/Y	Home & amusement processor	<ul style="list-style-type: none"> <li>Capable of moving picture transmission/play, thanks to real-time image compression and extension technology</li> <li>Real images, backgrounds and sprites can be superimposed</li> <li>Built-in sprite processor</li> <li>Built-in color object detector</li> <li>Built-in Bluetooth® interface</li> <li>Built-in sound generator (ADPCM/PSG)</li> <li>Built-in CMOS camera module interface</li> <li>Built-in video encoder : NTSC/PAL composite signal output</li> <li>Analog RGB signal output</li> <li>CPU : Z80 compatible</li> <li>PIO, UART, SIO, NAND flash memory I/F, ADC, PWM, SPI, etc.</li> </ul>	Core : 1.8 ± 0.18 I/O : 3.3 ± 0.3	P-QFP128-1420/ TFBGA160-1212
LR38886	Image detection engine	<ul style="list-style-type: none"> <li>High-speed image processing : 960 MOPS (MAX.)</li> <li>Built-in camera interface : 8-bit digital input (UYVY etc.), Can be connected to a camera directly, up to 4-million pixel camera</li> <li>Built-in SDRAM interface : 512 Mbits (MAX.)</li> <li>Universal I/O : 15 ports (MAX.)</li> <li>Serial interface (SPI)</li> <li>Bus interface (Bus Master)</li> <li>Built-in PLL (200 MHz (MAX.))</li> <li>Automatic control of power consumption according to amount of data processed</li> </ul>	Core : 1.8 (TYP.) I/O : 3.3 (TYP.)	P-LQFP176-2424
LR38875	RSDS transmitter	<ul style="list-style-type: none"> <li>RSDS™*2 spec. V095 compliant</li> <li>Low EMI*3 generation</li> <li>Low current consumption : 50 mA (MAX. at 85 MHz)</li> <li>High noise rejection</li> <li>Data rate : 50 to 180 Mbps (CLK : at 25 to 90 MHz)</li> <li>Clock delay timing of RSDS™*2 output can be controlled by external register</li> <li>RSDS™*2 swing output voltage can be controlled by external load resistor</li> </ul>	3.3 ± 0.3	P-TQFP100-1414
LR388733	USB On-The-Go controller	<ul style="list-style-type: none"> <li>USB2.0 supplemental standard OTG1.0 compliant</li> <li>Connectable to a product whose data transfer speed 12 Mbps and 1.5 Mbps</li> <li>Built-in 2-ch USB line driver (2-port root HUB function)</li> <li>Asynchronous SRAM-compatible interface</li> <li>Supports 4 transfer modes (control, bulk, interrupt and isochronous)</li> </ul>	Core : 3.3 (TYP.) I/O (USB) : 3.3/5	P-QFP072-1010

\*1 MDDI (Mobile Display Digital Interface) : The serial interface standard developed by QUALCOMM

\*2 RSDS™ : Reduced Swing Differential Signaling

\*3 EMI : Electro-Magnetic Interference

The IPs contribute to shorter development time, effective use of existing software and improvement in reliability. SHARP is promoting a comprehensive range of IPs to provide support for top-down design using logic synthesis.

## ■ CPU Cores

IP	Macro	Function	Data type	
			Hard	Soft
ARM	ARM7TDMI	32-bit RISC ARM7TDMI CPU Core (16-bit Ins. mode supported)	○	○
	ARM720T	ARM7TDMI + MMU + 8-Kbyte Cache	○	
	ARM922T	ARM9TDMI + MMU + 8-Kbyte I-cache + 8-Kbyte D-cache	○	
	ARM946E-S	ARM9E + PU + I-cache (configurable) + D-cache (configurable) + TCM (configurable)		○
	ARM926EJ-S	ARM9E + MMU + I-cache (configurable) + D-cache (configurable) + TCM (configurable) + Java		○

## ■ Peripherals

IP	Macro	Function	Data type	
			Hard	Soft
Bus Interface				
PCMCIA	PCMCIA1	PCMCIA PC card interface		○
	82365SL	PCMCIA card interface controller		○
IEEE1284	1284	IEEE 1284 host parallel port		○
I2C	I2C	I <sup>2</sup> C bus interface		○
FDD-cntl	FDC78	High performance PC compatible floppy disk controller system (82078SL)		○
	765A78	Extended features floppy disk controller core for FM and MFM formats		○
Microcontroller & Microprocessor				
8-bit-cntl	8051	High performance industry compatible 8-bit microcontroller with 2 timers		○
Microprocessor Peripheral				
SDRAMC		Synchronous DRAM Controller		○
DMA	8237A	General purpose programmable 4-channel DMA controller		○
LCDC		Color LCD Controller (TFT, HR-TFT, CSTN, STN, DMTN)		○
PIT	8254	Extended feature 3-channel Programmable Interval Timer (PIT)		○
RTC	146818	Ultra-low-power real time clock with up to 114 bytes of RAM		○
PIC	8259A	8-channel cascadable Programmable Interrupt Controller (PIC)		○
PPI	8255	General purpose Programmable Peripheral Interface (PPI)		○
INTC		Interrupt Controller		○
Serial Communication				
USB-OTG		Universal Serial Bus On The Go Controller Full Speed (12 MHz)/ Low Speed (1.5 MHz)/High Speed (480 MHz)		○
USART	8251A	Universal Synchronous/Asynchronous Receiver/Transmitter (USART)		○
SSP		Synchronous Serial Port		○
SCC	85C30	SCC 2-channel Serial Communications Controller with FIFOs		○
UART	16550A	Universal Asynchronous Receiver/Transmitter (UART) with FIFO		○
	6402	Compact Universal Asynchronous Receiver/Transmitter (UART)		○

## ■ Analog Cells

IP	Macro	Function	Data type	
			Hard	Soft
ADC	High Speed ADC	8-bit AD (80 MHz), 10-bit AD (80 MHz), 6-bit AD (80 MHz)	○	
	Voice ADC	12-bit AD/14-bit AD (8 to 32 kHz)	○	
	Audio ADC	20-bit AD (44.1 kHz)	○	
DAC	High Speed DAC	8-bit DA/9-bit DA (30 MHz)	○	
	Voice DAC	10-bit DA (8 to 32 kHz)	○	
	Audio DAC	20-bit DA (44.1 kHz)	○	

## ■ Analog PLL (Phase Locked Loop)

IP	Macro	Function	Data type	
			Hard	Soft
PLL	PLL	Fout : 100 to 200 MHz	○	
		Fout : 200 to 400 MHz	○	
		Fout : 400 to 800 MHz	○	
		Fin : 32 kHz, Fout : 33 to 134 MHz	○	

## ■ Others

IP	Macro	Function	Data type	
			Hard	Soft
LVDS	LVDS Receiver	Input signal : 7-bit 3 ch (6 bits for RGB), 85 MHz (MAX.)	○	
		Input signal : 7-bit 4 ch (8 bits for RGB), 85 MHz (MAX.)	○	
RSDS	RSDS Transmitter	Input signal : 8 bits for RGB, 90 MHz (MAX.)	○	

Contact a SHARP sales office about applicable series. A use-fee and license-fee are required for use of the above IPs.



## Smart Cards/LSI Modules for Smart Cards

Type	Communication standards	Protocol	Transmission speed (kbps) MAX.	Nonvolatile memory capacity	Cycling capability	CPU	Security system	
SJCard 211	Contact	ISO/IEC7816	T = 1	19.2	1 Mbyte (Flash memory)	100 000 times	16 bits	RSA, DES, T-DES, etc. high-speed cryptographic authentication with built-in coprocessor, hardware-based random number generator
	Contactless	ISO/IEC14443 Type B	ISO/IEC14443-4	424				
JCOP*	Contact	ISO/IEC7816	T = 0, 1	76.8	1 Mbyte (Flash memory)	100 000 times	16 bits	
	Contactless	ISO/IEC14443 Type B	ISO/IEC14443-4	424				
(Under development)	Contact	ISO/IEC7816	T = 0, 1	76.8	1 Mbyte (Flash memory)	100 000 times	32-bit MIPS	(Under development)
	Contactless	ISO/IEC14443 Type B	ISO/IEC14443-4	424				



SJ card211

- Java Card™ 2.1.1 compliance
- Capable of developing applications using Java language



JCOP\* card

- Java Card™ 2.2 compliance
- GP (Global Platform) 2.1.1 compliance
- EMV 2000 compliance
- Capable of developing applications using Java language



★32-bit MIPS card

- With built-in 32-bit MIPS on CPU
- Security upgrades thanks to secure controller, MIPS32™ 4Ksd™

\*JCOP : JCOP means IBM's Java Card Open Platform, which was developed by IBM Corporation as an embedded Operating System (OS) for smart cards which conforms to the standards of Java and Global Platform. This platform ensures the security of applications working on various mobile terminals, such as a USB key and a smart card suitable for multiple applications.

## ■ Reader/Writer for Smart Cards

Type	Model No.	Communication standard	Host interface	Transmission speed between smart card and RW (kbps)	Smart card operation method	Outline dimensions W x H x D (mm)	Mass (g)	Power supply
Contact type	RW-4040	ISO/IEC7816 (T = 0, 1)	USB1.1	9.6 to 153.6	Manual insertion/ Manual ejection	70.4 x 14.1 x 60.5	Approx. 65	DC 5 V (USB connector)
	RW-4020 (LR550R03)	ISO/IEC7816 (T = 0, 1)	PC card interface Type II	10.8 to 344.1		54 x 5 x 85.6	Approx. 30	DC 5 V (PC card connector)



Contact type reader/writer  
RW-4040

- High-speed data communication
- Conforms to PC/SC standard
- USB interface



Contact type reader/writer  
RW-4020 (LR550R03)

- High-speed data communication
- PC card interface Type II

## ■ SDK (Software Development Kit) for Smart Cards

SDK type	Contents
For SJCard 211	Development kit CD for SJCard SJCard simulator Contact type reader/writer (1 set)
For JCOP	Development kit CD for JCOP31id Card





## Highly Functional Flash Memories

### Boot Block Type 3 V Page Mode Flash Memories: LH28FXXXBF Series

Capacity (bit)	Bit configuration	Erasable block size		Operating temp. (°C)	Model No.	Remarks
64 M	x 16	4 Kwords x 8, 32 Kwords x 127	Top boot	-40 to 85	LH28F640BFH-PTTL	<ul style="list-style-type: none"> <li>Built-in dual work function</li> <li>Built-in OTP function [4 words (factory area) + 4 words (user area) ]</li> </ul>
			Bottom boot	-40 to 85	LH28F640BFH-PBTL	
128 M	x 16	4 Kwords x 8, 32 Kwords x 255	Top boot	-40 to 85	LH28F128BFH-PTTL	
			Bottom boot	-40 to 85	LH28F128BFH-PBTL	

## Standard Flash Memories

### Boot Block Type 3 V Flash Memories: LH28FXXXBJ Series

Capacity (bit)	Bit configuration	Erasable block size		Operating temp. (°C)	Model No.	Remarks
8 M	x 8/ x 16	4 Kwords x 8, 32 Kwords x 15 (or 8 Kbytes x 8, 64 Kbytes x 15)	Top boot	0 to 70	LH28F800BJ-PTTL	<ul style="list-style-type: none"> <li>Built-in OTP function [4 words (factory area) + 3 963 words (user area) ]</li> </ul>
				-40 to 85	LH28F800BJH-PTTL	
			Bottom boot	0 to 70	LH28F800BJ-PBTL	
				-40 to 85	LH28F800BJH-PBTL	
16 M	x 8/ x 16	4 Kwords x 8, 32 Kwords x 31 (or 8 Kbytes x 8, 64 Kbytes x 31)	Top boot	-40 to 85	LH28F160BJH-PTTL	-
			Bottom boot	-40 to 85	LH28F160BJH-PBTL	



■ Fast-Reprogramming System-Flash for Digital Equipment

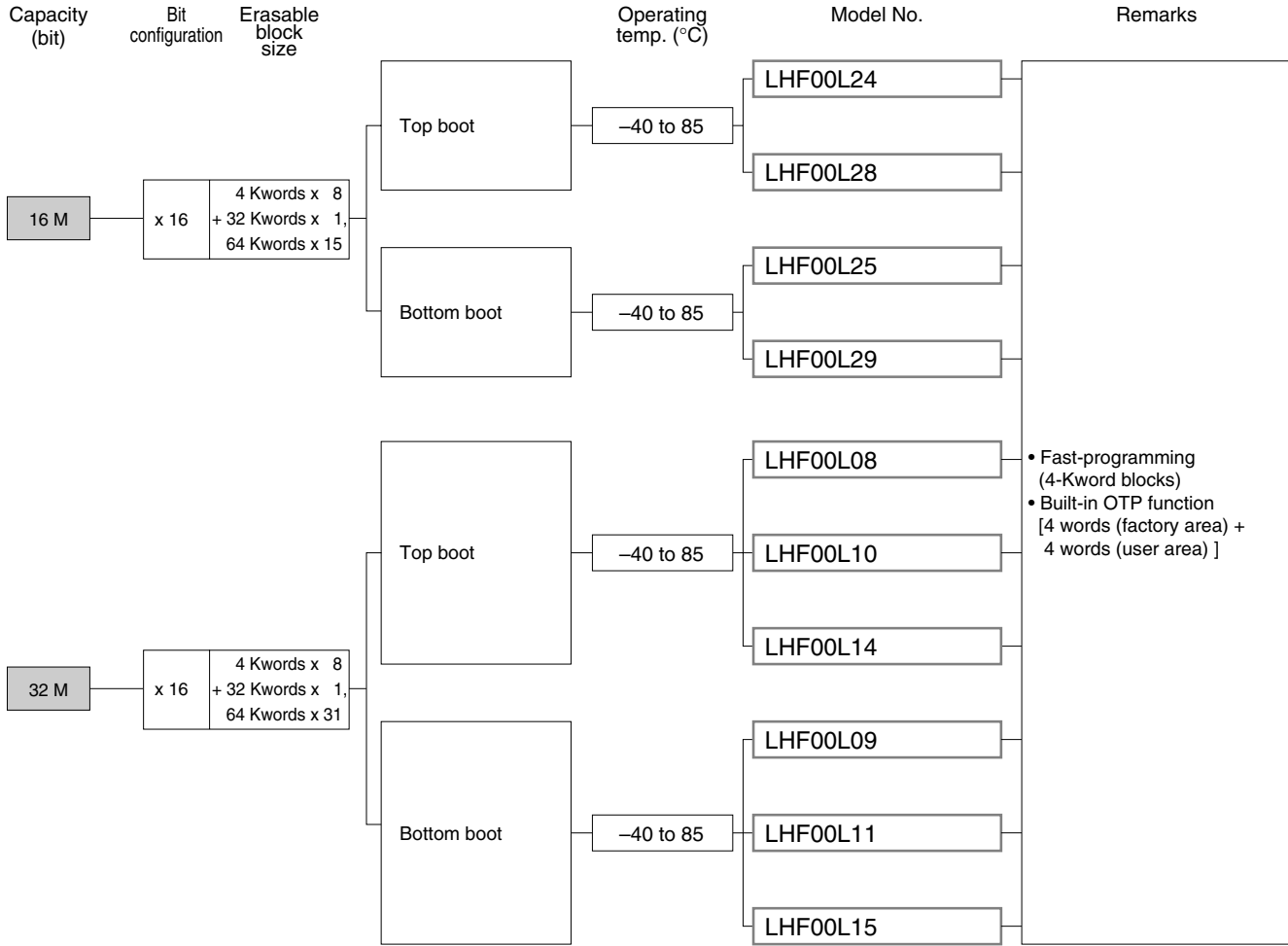

■ System-Flash for Amusement Products

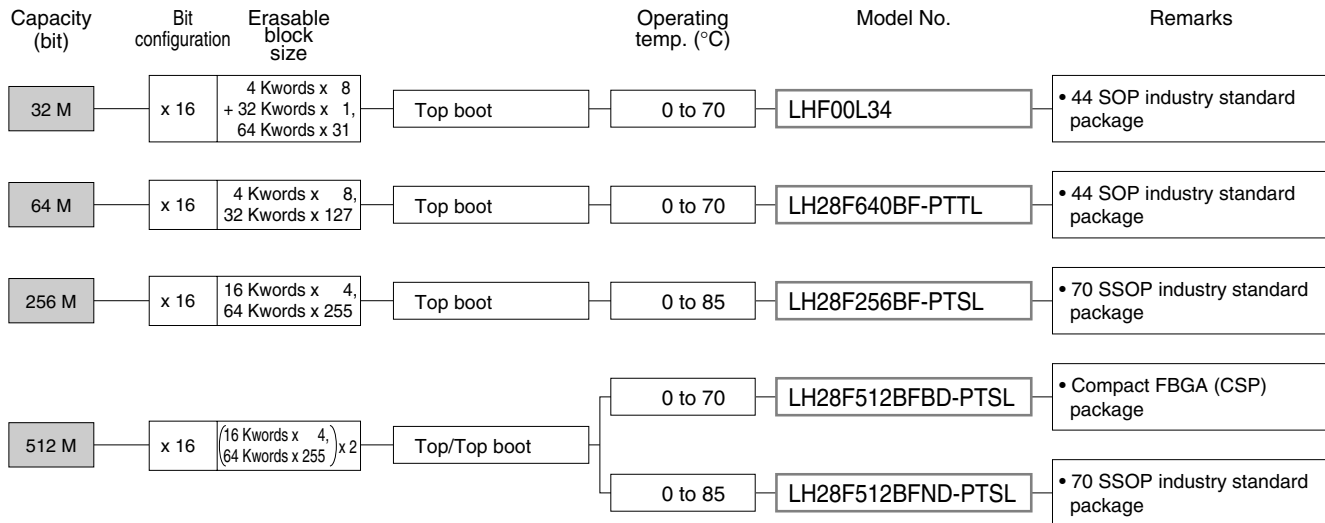



## System-Flash for Automotive Use

Capacity (bit)	Bit configuration	Erasable block size		Operating temp. (°C)	Model No.	Remarks
32 M	x 16	4 Kwords x 8, 32 Kwords x 63	Top boot	-40 to 85	LH28F320BFH-PTTL	<ul style="list-style-type: none"> <li>• Employs copper frame</li> </ul>
64 M	x 16	4 Kwords x 8, 32 Kwords x 127	Top boot	-40 to 85	LH28F640BFH-PTTL	
			Bottom boot		LH28F640BFH-PBTL	
128 M	x 16	4 Kwords x 8, 32 Kwords x 255	Top boot	-40 to 85	LH28F128BFH-PTTL	
	x 16	(4 Kwords x 8, 32 Kwords x 127) x 2	Top/Bottom boot		LH28F128BFH-PWTL	
256 M	x 16	(4 Kwords x 8, 32 Kwords x 255) x 2	Top/Top boot	-40 to 85	LH28F256BFH-PTTL	

## System-Flash for Network Equipment

Capacity (bit)	Bit configuration	Erasable block size		Operating temp. (°C)	Model No.	Remarks
64 M	x 8/ x 16	64 Kwords x 64 or 128 Kbytes x 64	Symmetrical block	-40 to 85	LH28F640SPH-PL	<ul style="list-style-type: none"> <li>• 56 TSOP industry standard package</li> </ul>
128 M	x 8/ x 16	64 Kwords x 128 or 128 Kbytes x 128	Symmetrical block	-40 to 85	LH28F128SPH-PTL	<ul style="list-style-type: none"> <li>• 56 TSOP industry standard package</li> </ul>



## Highly Functional Flash Memories Boot Block Type 3 V Page Mode Flash Memories: LH28FXXXBF Series

Supply voltage		64 M : $V_{CC} = 2.7$ to $3.6$ V, $V_{PP} = 1.65$ to $3.6$ V or $9.0$ to $10.0$ V 128 M : $V_{CC} = 2.7$ to $3.6$ V, $V_{PP} = 2.7$ to $3.6$ V or $9.0$ to $10.0$ V								
Capacity (bit)	Bit configuration	Erasable block size		Model No.	Access time (ns) MAX.	Page mode access time (ns) MAX.	Read current (mA) MAX. $f = 5$ MHz (CMOS)	Standby current ( $\mu$ A) MAX. (CMOS)	Operating temp. ( $^{\circ}$ C)	Package
64 M	x 16	Parameter : 4 Kwords x 8 Main : 32 Kwords x 127	Top boot	LH28F640BFHE-PTTLHFA	70	30	25	20	-40 to 85	P-TSOP048-1220 (Normal bend)
			Bottom boot	LH28F640BFHG-PTTL70A						TFBGA048-0808
128 M	x 16	Parameter : 4 Kwords x 8 Main : 32 Kwords x 255	Top boot	LH28F128BFHT/B-PTTL75A	75	25	35	40		P-TSOP048-1220 (Normal bend)/ TFBGA048-0808
			Bottom boot	LH28F128BFHT/B-PBTL75A						P-TSOP056-1420 (Normal bend)/ LFBGA072-0811

Contact a SHARP sales office for other packages and top boot/bottom boot models other than those listed above.

## Standard Flash Memories Boot Block Type 3 V Flash Memories: LH28FXXXBJ Series

Supply voltage		$V_{CC} = 2.7$ to $3.6$ V, $V_{CCW} = 2.7$ to $3.6$ V or $11.7$ to $12.3$ V										
Capacity (bit)	Bit configuration	Erasable block size		Model No.	Access time (ns) MAX.	Read current (mA) MAX. $f = 5$ MHz (CMOS)	Standby current ( $\mu$ A) MAX. (CMOS)	Operating temp. ( $^{\circ}$ C)	Package			
8 M	x 8/ x 16	Boot : 4 Kwords (8 Kbytes) x 2 Parameter : 4 Kwords (8 Kbytes) x 6 Main : 32 Kwords (64 Kbytes) x 15	Top boot	LH28F800BJE-PTTL90	90	25	15	0 to 70	P-TSOP048-1220 (Normal bend)			
			Bottom boot	LH28F800BJHE-PTTL90				-40 to 85				
			16 M	x 8/ x 16	Boot : 4 Kwords (8 Kbytes) x 2 Parameter : 4 Kwords (8 Kbytes) x 6 Main : 32 Kwords (64 Kbytes) x 31	Top boot	LH28F160BJHE-PTTL70	70		25	15	0 to 70
						Bottom boot	LH28F160BJHE-PBTL70					-40 to 85

Contact a SHARP sales office for other packages and top boot/bottom boot models other than those listed above.



## ■ Fast-Reprogramming System-Flash for Digital Equipment

Supply voltage		$V_{CC} = 2.7$ to $3.6$ V, $V_{PP} = 11.7$ to $12.3$ V								
Capacity (bit)	Bit configuration	Erasable block size		Model No.	Access time (ns) MAX.	4-Kword programming time (s)	Read current (mA) MAX. f = 5 MHz (CMOS)	Standby current ( $\mu$ A) MAX. (CMOS)	Operating temp. ( $^{\circ}$ C)	Package
16 M	x 16	Parameter : 4 Kwords x 8 + 32 Kwords x 1 Main : 64 Kwords x 15	Top boot	LHF00L24	70	0.31	17	10	-40 to 85	TFBGA048-0608
				LHF00L28						P-TSOP048-1220 (Normal bend)
			Bottom boot	LHF00L25	70	0.31	17	10	-40 to 85	TFBGA048-0608
				LHF00L29						P-TSOP048-1220 (Normal bend)
32 M	x 16	Parameter : 4 Kwords x 8 + 32 Kwords x 1 Main : 64 Kwords x 31	Top boot	LHF00L08	90	0.31	17	10	-40 to 85	TFBGA048-0608
				LHF00L10						TFBGA048-0707
				LHF00L14						P-TSOP048-1220 (Normal bend)
			Bottom boot	LHF00L09	90	0.31	17	10	-40 to 85	TFBGA048-0608
				LHF00L11						TFBGA048-0707
				LHF00L15						P-TSOP048-1220 (Normal bend)

Contact a SHARP sales office for other packages and top boot/bottom boot models other than those listed above.

## ■ System-Flash for Amusement Products

Supply voltage		32 M/64 M : $V_{CC} = 2.7$ to $3.6$ V 256 M/512 M : $V_{CC} = 1.7$ to $1.95$ V, $V_{CCQ} = 2.7$ to $3.6$ V, $V_{PP} = 0.9$ to $1.95$ V or $8.5$ to $9.5$ V								
Capacity (bit)	Bit configuration	Erasable block size		Model No.	Access time (ns) MAX.	Page mode access time (ns) MAX.	Read current (mA) MAX. f = 5 MHz (CMOS)	Standby current ( $\mu$ A) MAX. (CMOS)	Operating temp. ( $^{\circ}$ C)	Package
32 M	x 16	Parameter : 4 Kwords x 8 + 32 Kwords x 1 Main : 64 Kwords x 31	Top boot	LHF00L34	90	-	17	10	0 to 70	P-SOP044-0600
64 M	x 16	Parameter : 4 Kwords x 8 Main : 32 Kwords x 127	Top boot	LH28F640BFN-PTTLZ1A	90	35	25	25	0 to 70	P-SOP044-0600
256 M	x 16	Parameter : 16 Kwords x 4 Main : 64 Kwords x 255	Top boot	LH28F256BFN-PTSLZ2	100	25	22	60	0 to 85	P-SSOP070-0500
512 M	x 16	(Parameter : 16 Kwords x 4 Main : 64 Kwords x 255) x 2	Top/ Top boot	LH28F512BFBD-PTSLZ4	85	25	22	120	0 to 70	LFBGA072-0811
				LH28F512BFBD-PTSLZ2	90					
				LH28F512BFND-PTSLZ1	100				0 to 85	P-SSOP070-0500

Contact a SHARP sales office for other packages and top boot/bottom boot models other than those listed above.

**■ System-Flash for Automotive Use**

Supply voltage		V <sub>CC</sub> = 2.7 to 3.6 V, V <sub>CCQ</sub> = 2.7 to 3.6 V								
Capacity (bit)	Bit configuration	Erased block size		Model No.	Access time (ns) MAX.	Page mode access time (ns) MAX.	Read current (mA) MAX. f = 5 MHz (CMOS)	Standby current (μA) MAX. (CMOS)	Operating temp. (°C)	Package
32 M	x 16	Parameter : 4 Kwords x 8 Main : 32 Kwords x 63	Top boot	LH28F320BFHE-PTTLE0	70	25	25	20	-40 to 85	P-TSOP048-1220 (Normal bend)
64 M	x 16	Parameter : 4 Kwords x 8 Main : 32 Kwords x 127	Top boot	LH28F640BFHE-PTTLH1A	70	30	25	20	-40 to 85	P-TSOP048-1220 (Normal bend)
		Parameter : 4 Kwords x 8 Main : 32 Kwords x 127	Bottom boot	LH28F640BFHE-PBTLHK	70	30	25	20	-40 to 85	
128 M	x 16	Parameter : 4 Kwords x 8 Main : 32 Kwords x 255	Top boot	LH28F128BFHT-PTTLT1A	75	25	35	40	-40 to 85	P-TSOP056-1420 (Normal bend)
		Parameter : 4 Kwords x 8 Main : 32 Kwords x 127	Top/ Bottom boot	LH28F128BFHED-PWTLT2	70	30	25	40	-40 to 85	P-TSOP048-1220 (Normal bend)
256 M	x 16	Parameter : 4 Kwords x 8 Main : 32 Kwords x 255	Top/ Top boot	LH28F256BFHTD-PTTLZ3	75	25	40	80	-40 to 85	P-TSOP056-1420 (Normal bend)

**■ System-Flash for Network Equipment**

Supply voltage		V <sub>CC</sub> = 2.7 to 3.6 V, V <sub>PP</sub> = 2.7 to 3.6 V or 9.0 to 10.0 V								
Capacity (bit)	Bit configuration	Erased block size		Model No.	Access time (ns) MAX.	Page mode access time (ns) MAX.	Read current (mA) MAX. f = 5 MHz (CMOS)	Standby current (μA) MAX. (CMOS)	Operating temp. (°C)	Package
64 M	x 8/ x 16	64 Kwords x 64 or 128 Kbytes x 64	Symmetrical block	LH28F640SPHT-PL12B	120	25	15	120	-40 to 85	P-TSOP056-1420
128 M	x 8/ x 16	64 Kwords x 128 or 128 Kbytes x 128	Symmetrical block	LH28F128SPHT-PTL12B	120	25	15	120	-40 to 85	P-TSOP056-1420



# COMBINATION MEMORIES

★Under development



## ■ Boot Block Type Flash Memory + Pseudo SRAM

### ● 1.8 V models with 1.8 V I/O voltage

Model No.	Flash memory block configuration	Capacity (bit) [Bit configuration]		Access time (ns) MAX.						Supply voltage (V)			Package
		Flash memory	Pseudo SRAM	Flash memory			Pseudo SRAM			Flash memory core voltage	Pseudo SRAM core voltage	I/O voltage	
				Random mode	Page mode	Synchronous burst mode	Random mode	Page mode	Synchronous burst mode				
LRS1890A	Bottom boot	256 M [x 16]	64 M [x 16]	85	25	-	70	20	-	1.7 to 1.95	1.7 to 1.95	1.7 to 1.95	LFBGA072-0811
LRS18A6			128 M [x 16]							1.7 to 1.9	2.7 to 3.1	1.7 to 1.9	LFBGA072-0811
LRS1897	Bottom/Top boot	512 M [x 16]	128 M [x 16]	85	25	-	70	20	-	1.7 to 1.9	2.7 to 3.1	1.7 to 1.9	LFBGA072-0811
LRS18CCA	Bottom/Top/Bottom boot	740 M [x 16]	256 M [x 16]	93	25	52 MHz	70	20	83 MHz	1.7 to 1.95	1.7 to 1.95	1.7 to 1.95	LFBGA088-0912
LRS18CP	Bottom boot	128 M [x 16]	64 M [x 16]	85	25	-	70	20	-	1.7 to 1.95	1.7 to 1.95	1.7 to 1.95	LFBGA072-0811

### ● 1.8 V models with 3 V I/O voltage

Model No.	Flash memory block configuration	Capacity (bit) [Bit configuration]		Access time (ns) MAX.						Supply voltage (V)			Package		
		Flash memory	Pseudo SRAM	Flash memory			Pseudo SRAM			Flash memory core voltage	Pseudo SRAM core voltage	I/O voltage			
				Random mode	Page mode	Synchronous burst mode	Random mode	Page mode	Synchronous burst mode						
LRS18CJ	Top boot	64 M [x 16]	16 M [x 16]	85	25	-	65	20	-	1.7 to 1.95	2.7 to 3.1	2.7 to 3.1	LFBGA072-0811		
LRS18CK	Bottom boot														
LRS18BK	Top boot	128 M [x 16]	32 M [x 16]	85	25	54 MHz	65	20	-	1.7 to 1.95	2.7 to 3.1	2.7 to 3.1	LFBGA088-0811		
LRS18BL	Bottom boot												64 M [x 16]	54 MHz	LFBGA072-0811
★LRS18C8C															-
LRS18BN			54 MHz			LFBGA088-0811									
LRS18AZ*			256 M [x 16]			64 M [x 16]								54 MHz	LFBGA088-0811
LRS18B0*														-	LFBGA072-0811

\* This flash memory is divided into two banks, each including an enable signal.

### ● 3 V models with 3 V I/O voltage

Model No.	Flash memory block configuration	Capacity (bit) [Bit configuration]		Access time (ns) MAX.						Supply voltage (V)			Package
		Flash memory	Pseudo SRAM	Flash memory			Pseudo SRAM			Flash memory core voltage	Pseudo SRAM core voltage	I/O voltage	
				Random mode	Page mode	Synchronous burst mode	Random mode	Page mode	Synchronous burst mode				
LRS18BT	Bottom boot	32 M [x 16]	8 M [x 16]	85	-	-	85	-	-	2.7 to 3.1	2.7 to 3.1	2.7 to 3.1	LFBGA072-0811
LRS1871A	Top boot	64 M [x 16]	16 M [x 16]	85	35	-	85	-	-	2.7 to 3.3	2.7 to 3.1	2.7 to 3.1	LFBGA072-0811
LRS1872A	Bottom boot												
LRS18831	Top boot		32 M [x 16]	70	35	-	60	-	-	2.7 to 3.1	2.7 to 3.1	2.7 to 3.1	LFBGA072-0811
LRS18841	Bottom boot												



Low Power-Loss Voltage Regulators

TO-220 type

(Ta = 25°C)

Model No.	Features	Absolute maximum ratings				Electrical characteristics			Built-in functions							Package Package shape type <sup>*7</sup>									
		Output current I <sub>o</sub> (A)	Input voltage V <sub>in</sub> (V)	Power dissipation (W)		Output voltage V <sub>o</sub> <sup>*3</sup> (V) TYP.	Output voltage precision (%)	Dropout voltage V <sub>i-o</sub> <sup>*5</sup> (V)	Overheat protection	Overcurrent protection	ON/OFF control	Low dissipation current at OFF state	Variable output voltage	Lead forming available											
				Pd <sup>*1</sup>	Pd <sup>*2</sup>																				
PQxxRD08J00H series	ASO protection function	0.8	20	1.25	10	5, 9, 12	±3	0.5	○	○	○	○	○	○	○	○	TO-220	A							
PQ3RD083J00H						3.3												A							
PQ6RD083J00H						6.3												A							
PQxxRA11J00H series	Low dissipation current at OFF state (I <sub>qs</sub> : 1μA (MAX.))	1	35	1.5	15	5, 9, 12	±2.5	0.5	○	○	○	○	○	○	○	○	TO-220	B							
PQxxRD11J00H series	ASO protection function		20	1.4		5, 9, 12												±3	○	○	○	○	○	○	A
PQxxxRDA1SZH series	ASO protection function, low dissipation current at OFF state (I <sub>qs</sub> : 5μA (MAX.))		24	5, 8, 9, 12		±2.5												○	○	○	○	○	○	A	
PQxxxRDA2SZH series	ASO protection function	2	20	–	–	3.3, 5, 9, 12	±2.5	0.5	○	○	○	○	○	○	○	○	TO-220	A							
PQ3RD13J000H	ASO protection function	1	10	1.4	15	3.3	±3											○	○	○	○	○	○	A	
PQxxEF01SZH series	Minimum operating input voltage : 2.35 V (4 terminals)					1.5, 1.8, 2.5, 3.3	±2.5											○	○	○	○	○	○	A	
PQxxEF02SZH series	2					○	○	○	○	○	○	○	A												
PQxxRF11J00H series	General purpose	1	35	1.5	18	5, 9, 12	±2.5	0.5	○	○	○	○	○	○	○	○	TO-220	B							
PQxxRH11J00H series		1.5	○	○		○												○	○	○	○	B			
PQ3RD23J000H	ASO protection function	2	20	1.4	15	3.3	±3											○	○	○	○	○	○	○	○
PQxxRD21J00H series			35	5, 9, 12	○	○	○	○	○	A															
PQxxRF21J00H series	General purpose	3.5	10	1.5	18	3.3	±2.5	0.5	○	○	○	○	○	○	○	○	TO-220	B							
PQ3RF23J000H	High output current																	1.8	○	○	○	○	○	B	
PQ3RF33J000H	1																	○	○	○	○	○	○	A	
PQ070XF01SZH	Minimum operating input voltage : 2.35 V (4 terminals)	1	10	1.4	15	1.5 to 7	±2 <sup>*4</sup>	0.5	○	○	○	○	○	○	○	○	TO-220	A							
PQ070XF02SZH		2																○	○	○	○	○	A		
PQ070VK01FZH	Minimum operating input voltage : 2.35 V (5 terminals)	1	17	1.5	12.5	1.5 to 15	±2 <sup>*4</sup>											0.5	○	○	○	○	○	○	○
PQ070VK02FZH		2						○	○	○	○	○	E												
PQ15RW08J00H	ASO protection function, minimum operating input voltage : 3.5 V	0.8	20	1.25	10	3.0 to 15	±2.5 <sup>*4</sup>	0.5	○	○	○	○	○	○	○	○	TO-220								
PQ15RW11J00H		1		1.4	15													○	○	○	A				
PQ15RW21J00H		2		–	–													○	○	○	A				
PQ150RWA2SZH	ASO protection function	0.5	24	1.25	10	3.0 to 20	±2.5 <sup>*4</sup>	0.5	○	○	○	○	○	○	○	○	TO-220	C							
PQ20RX05J00H	Variable output voltage, output ON/OFF control																	○	○	○	○	○	C		
PQ20RX11J00H	1																	○	○	○	○	○	C		
PQ150VB01FZH	Overheat shutdown circuit, minimum operating input voltage : 2.35 V (5 terminals)	1	17	1.5	12.5	1.5 to 15	±2 <sup>*4</sup>	0.5	○	○	○	○	○	○	○	○	TO-220	E							
PQ150VB02FZH		2																○	○	○	○	○	E		
PQ30RV11J00H	Variable output voltage	1	35	1.5	15	1.5 to 30	±2 <sup>*4</sup>											0.5	○	○	△ <sup>*6</sup>	○	○	○	○
PQ30RV21J00H		2						○	○	△ <sup>*6</sup>	○	○	B												
PQ30RV31J00H		3						○	○	△ <sup>*6</sup>	○	○	B												
PQ7RV4J0000H		4.6						10	1.8	18	1.5 to 7	○	○	△ <sup>*6</sup>	○	○	B								

\*1 At self-cooling  
 \*2 With infinite heat sink attached  
 \*3 The xx/xxx in the model No. refer to the output voltage values of the model (e.g. 05/050 for 5 V, 12/120 for 12 V, 015 for 1.5 V).  
 \*4 Reference voltage accuracy  
 \*5 Current ratings are defined individually.  
 \*6 △ : Available by adding circuit  
 \*7 Refer to page 65



## ●High output current type [TO-220 high heat radiation type, TO-3P type]

(Ta = 25°C)

Model No.	Features	Absolute maximum ratings				Electrical characteristics			Built-in functions				Package
		Output current I <sub>o</sub> (A)	Input voltage V <sub>in</sub> (V)	Power dissipation (W)		Output voltage V <sub>o</sub> (V)	Output voltage precision (%)	Dropout voltage V <sub>i-o</sub> *4 (V)	Overheat protection	Overcurrent protection	ON/OFF control	Variable output voltage	
				Pd*1	Pd*2								
PQ5EV3J0000H	High output current, minimum operating input voltage : 2.35 V	3.5	7	1.6	45	1.5 to 5	±1*3	0.5	○	○	○	○	TO-220 (heat sink exposure)
PQ5EV5J0000H		5							○	○	○	○	
PQ5EV7J0000H		7.5							○	○	○	○	

\*1 At self-cooling

\*2 With infinite heat sink attached

\*3 Reference voltage accuracy

\*4 Current ratings are defined individually.

## ●Low output current type [TO-92 type]

(Ta = 25°C)

Model No.	Features	Absolute maximum ratings			Electrical characteristics			Built-in functions		Package
		Output current I <sub>o</sub> (A)	Input voltage V <sub>in</sub> (V)	Power dissipation Pd*1 (W)	Output voltage V <sub>o</sub> (V) TYP.	Output voltage precision (%)	Dropout voltage V <sub>i-o</sub> (V)	Overheat protection	Overcurrent protection	
PQ033ES1MXPQ	Low output current type with general purpose TO-92 package (for auxiliary power supply)	0.15	16	0.52	3.3	±2	0.4 (I <sub>o</sub> = 150 mA)	○	○	TO-92
PQ050ES1MXPQ					5			○	○	
PQ033ES3MXPQ		0.3	9		3.3		0.7 (I <sub>o</sub> = 300 mA)	○	○	
PQ050ES3MXPQ					5			○	○	

\*1 At self-cooling

## ■ Surface Mount Type Low Power-Loss Voltage Regulators

### ● SOT-23-5 type

(Ta = 25°C)

Model No.	Features	Absolute maximum ratings			Electrical characteristics				Built-in functions				Package
		Input voltage Vin (V)	Power dissipation Pd*1 (W)	Output current Io (A)	Output voltage Vo*2 (V) TYP.	Output voltage precision (%)	Dropout voltage Vi-o (V)	Overheat protection	Overcurrent protection	ON/OFF control	Low dissipation current at OFF state		
PQ1Uxx1M2ZPH series	Compact, low output current	16	0.35	0.18	1.8, 2.5, 2.8, 3.0, 3.3, 3.5, 5.0	± 2.0 (3.0 V output)	0.26 (Io = 60 mA)	○	○	○	○	SOT-23-5	
PQ1Xxx1M2ZPH series	Compact, ceramic capacitor compatible	9			*3			○	○	○	○		
PQ1AXxx1M2ZPH series	Compact, ceramic capacitor compatible, high reliability				*4	± 2.0		○	○	○	○		

\*1 When mounted on a board

\*2 The xx in the model No. refer to the output voltage values of the model (e.g. 50 for 5.0 V, 18 for 1.8 V).

\*3 1.5, 1.8, 2.5, 2.6, 2.7, 2.8, 2.9, 3.0, 3.3, 3.5, 3.7, 4.0, 4.5, 5.0 \*4 1.5, 1.8, 2.5, 3.0, 3.3, 5.0

### ● SOT-23L type

(Ta = 25°C)

Model No.	Features	Absolute maximum ratings			Electrical characteristics				Built-in functions				Package
		Output current Io (A)	Input voltage Vin (V)	Power dissipation Pd*1 (W)	Output current Io (A)	Output voltage Vo*2 (V) TYP.	Output voltage precision (%)	Dropout voltage Vi-o (V)	Overheat protection	Overcurrent protection	ON/OFF control	Low dissipation current at OFF state	
PQ1RxxJ0000H series	Compact, surface mount type, low dissipation current at OFF state (Iqs : 0.1 μA (MAX.))	–	16	0.4	0.18	*3	± 2.7 (3.0 V output)	0.26 (Io = 60 mA)	○	○	○	○	SOT-23L
PQ1Kxx3M2ZPH series	Compact, surface mount type, high ripple rejection, output current of up to 300 mA	0.3	9		–	1.8, 2.5, 3.0, 3.3, 3.6, 5.0	± 2.0 (3.0 V output)	0.7 (Io = 300 mA)	○	○	○	○	
PQ1KAXxx3M2ZPH series	Compact, surface mount type, output current of up to 300 mA, ceramic capacitor compatible		15		1.5, 1.8, 2.5, 3.3, 5.0, 9.0	○	○	○	○				

\*1 When mounted on a board

\*2 The xx in the model No. refer to the output voltage values of the model (e.g. 25 for 2.5 V, 47 for 4.7 V, 50 for 5.0 V).

\*3 1.8, 2.0, 2.3, 2.5, 2.7, 2.8, 2.9, 3.0, 3.2, 3.3, 3.4, 3.5, 3.7, 3.8, 4.0, 4.2, 4.4, 4.7, 4.9, 5.0, 5.2

### ● SOT-89 type

(Ta = 25°C)

Model No.	Features	Absolute maximum ratings			Electrical characteristics				Built-in functions				Package
		Output current Io (A)	Input voltage Vin (V)	Power dissipation Pd*1 (W)	Output voltage Vo*2 (V) TYP.	Output voltage precision (%)	Dropout voltage Vi-o*3 (V)	Overheat protection	Overcurrent protection	ON/OFF control	Low dissipation current at OFF state	Variable output voltage	
PQ1Lxx3M2SPQ	Compact, high radiation package, low dissipation current at OFF state (Iqs : 1 μA (MAX.))	0.3	16	0.9	1.5, 1.8, 2.5, 3.0, 3.2, 3.3, 5.0	± 2.0 (3.0 V output)	0.7	○	○	○	○	SOT-89	
PQ1LAXxx3MSPQ	Compact, high radiation package, low dissipation current at OFF state (Iqs : 1 μA (MAX.)), ceramic capacitor compatible		15		1.5, 1.8, 2.5, 3.3, 5.0, 9.0			○	○	○	○		
PQ1LAXxx5MSP series	Compact, high radiation package, ceramic capacitor compatible		0.5		9	1.5, 1.8, 2.5, 3.3, 5.0		± 2.0	○	○	○		○
PQ1LAX95MSPQ	Ceramic capacitor compatible, variable output voltage	1.5 to 9.0		± 2.0*6		○	○	○	○				
PQ1Mxx5M2SPQ	Compact, high output current, ceramic capacitor compatible	0.35	6	1.8, 2.5, 3.3, 5.0	± 2.0 (5.0 V output)	0.7	○	○	○	○	SOT-89		
PQ1MX55M2SPQ	Ceramic capacitor compatible, variable output voltage			1.3 to 5.0	± 2.0*6		○	○	○	○			
PQ1Nxx3MxSPQ	Reset signal output function*4, ceramic capacitor compatible			2.5, 3.3	± 2.0	○	○	○	○				
☆PQ1MGxx8MSPQ	Compact, ceramic capacitor compatible	0.8	6	0.8, 1.0, 1.2	± 2.0	–	○	○	○	○	SOT-89		
☆PQ1MGX38MSPQ	Compact, ceramic capacitor compatible, variable output type			0.5 to 3.5	± 2.0	–	○	○	○	○			
PQ2Lxxx2MSPQ	Compact, high radiation package, 2 outputs	0.25/ch	9	*5	–	0.4	○	○	○	○	SOT-89		

\*1 When mounted on a board

\*2 The xx in the model No. refer to the output voltage values of the model (e.g. 25 for 2.5 V, 50 for 5.0 V). [Except PQ2Lxxx2MSPQ]

\*3 Current ratings are defined individually.

\*4 Reset detection voltage : 4.2 V, 3.8 V

\*5 Output voltage combination : 3.3/3.3 V, 3.3/2.5 V, 3.3/1.8 V, 3.3/1.5 V, 2.5/1.8 V, 2.5/1.5 V

\*6 Reference voltage accuracy

●SC-63 type

(Ta = 25°C)

Model No.	Features	Absolute maximum ratings				Electrical characteristics				Built-in functions						Package Package shape type <sup>6</sup>			
		Output current I <sub>o</sub> (A)			Input voltage V <sub>in</sub> (V)	Power dissipation P <sub>d</sub> <sup>*1</sup> (W)	Output voltage V <sub>o</sub> <sup>*2</sup> (V) TYP.	Output voltage precision (%)	Dropout voltage V <sub>1-o</sub> <sup>*5</sup> (V)	Overheat protection	Overcurrent protection	ON/OFF control	Low dissipation current at OFF state	Variable output voltage	Taped package				
		0.5	1	1.5															
PQ07VR5MAPH series	Reset signal generation function (input voltage drop detection)	○			10	1.5 to 7	±2.0 <sup>*3</sup>		○	○			○	○	F				
PQ3DZ53J000H	ASO protection function, low dissipation current at OFF state (I <sub>qs</sub> : 5 mA (MAX.))	○			24	3.3	±3.0	0.5	○	○					F				
PQ3DZ13J000H			○							○	○							F	
PQxxDZ51J00H series		○							5, 9, 12			○	○					F	
PQxxDZ11J00H series			○									○	○					F	
PQxxxDNA1ZPH series		Ceramic capacitor compatible, ASO protection function, low dissipation current at OFF state (I <sub>qs</sub> : 5 mA (MAX.)), solder dip compatible lead shape		○						3.3, 5, 8, 9, 12			○	○					G
PQxxxDZ01ZPH series	Low dissipation current at OFF state (I <sub>qs</sub> : 5 μA (MAX.))		○		9, 10	3.3, 5			○	○					F				
PQxxxEZ5MZPH series	Minimum operating input voltage: 2.35 V	○				1.5, 1.8, 2.5, 3.0, 3.3	±2.5 <sup>*4</sup>		○	○					F				
PQxxxEZ01ZPH series			○							○	○							F	
PQxxxEN01ZPH series	Minimum operating input voltage: 2.35 V, solder dip compatible lead shape		○		10	1.5, 1.8, 2.5, 3.3	±2.5		○	○					G				
PQxxxENA1ZPH series	Minimum operating input voltage: 2.35 V, ceramic capacitor compatible, solder dip compatible lead shape		○							1.2, 1.5, 1.8, 2.5, 3.3	±2.0		○	○					G
★PQxxxENA1ZPH series			○								1.5, 1.8, 2.5, 3.3	-		○	○				G
PQxxxENAHZPH series				○		1.5, 1.8, 2.5, 3.0, 3.3	±2.5 <sup>*4</sup>	1.0	○	○					F				
PQxxxEZ1HZPH series	Minimum operating input voltage: 2.35 V			○		1.5, 1.8, 2.5, 3.0, 3.3	±2.5 <sup>*4</sup>	0.5	○	○					F				
PQxxxEZ02ZPH series				○ (2 A)						○	○							F	
PQxxxFZ5MZPH series	Minimum operating input voltage: 1.7 V (Dual power supply type)	○			3.7	1.0, 1.2	±30 mV		○	○					F				
PQxxxFZ01ZPH series				○						○	○							F	
PQxxxGN01ZPH series	Minimum operating input voltage: 1.7 V (Dual power supply type), ceramic capacitor compatible, solder dip compatible lead shape		○		5.5	0.8, 1.0, 1.2	-		○	○					G				
PQxxxGN1HZPH series				○						○	○							G	
★PQxxxGM02ZPH	Minimum operating input voltage: 1.1 V (Dual power supply type), ceramic capacitor compatible, solder dip compatible lead shape			○ (2 A)			±2.0	0.3	○	○					G				
PQ070XZ5MZPH series	Minimum operating input voltage: 2.35 V	○				1.5 to 7	±2.0 <sup>*3</sup>	0.5	○	○					F				
PQ070XZ01ZPH				○						○	○							F	
PQ070XN01ZPH	Minimum operating input voltage: 2.35 V, solder dip compatible lead shape		○		10	1.5 to 7	±2.0 <sup>*3</sup>	0.5	○	○					G				
PQ070XNA1ZPH	Minimum operating input voltage: 2.35 V, ceramic capacitor compatible, solder dip compatible lead shape		○										○	○				G	
PQ070XNAHZPH				○									○	○				G	
★PQ070XNB1ZPH			○				±2.0	-	○	○					G				

\*1 With infinite heat sink attached

\*2 The xx/xxx in the model No. refer to the output voltage values of the model (e.g. 033 for 3.3 V, 05/050 for 5 V, 12/120 for 12 V).

\*3 Reference voltage accuracy \*4 The value is defined as ± 50 mV in some models. \*5 Current ratings are defined individually. \*6 Refer to page 65

★Under development



●SC-63 type (cont'd)

(Ta = 25°C)

Model No.	Features	Absolute maximum ratings				Electrical characteristics			Built-in functions						Package Package shape type <sup>6</sup>	
		Output current I <sub>o</sub> (A)			Input voltage V <sub>in</sub> (V)	Power dissipation P <sub>d</sub> <sup>*1</sup> (W)	Output voltage V <sub>o</sub> <sup>*2</sup> (V) TYP.	Output voltage precision (%)	Dropout voltage V <sub>i-o</sub> <sup>*5</sup> (V)	Overheat protection	Overcurrent protection	ON/OFF control	Low dissipation current at OFF state	Variable output voltage		Taped package
		0.5	1	1.5												
PQ070XZ1HZPH	Minimum operating input voltage: 2.35 V			○	10	1.5 to 7	±2.0 <sup>*3</sup>	1.0	○	○	○	○	○	○	SC-63	F
PQ070XZ02ZPH				○ (2 A)				0.5	○	○	○	○	○	○		F
PQ015YZ5MZPH	Reference voltage (Vref): 1.0 V, minimum operating input voltage: 1.7 V (Dual power supply type)	○			3.7	1.0 to 1.5	±3.0 <sup>*3</sup>	-	○	○			○	○	F	
PQ015YZ01ZPH			○						○	○			○	○	F	
PQ035ZN01ZPH	Reference voltage (Vref): 0.6 V, minimum operating input voltage: 1.7 V (Dual power supply type), ceramic capacitor compatible, solder dip compatible lead shape		○		5.5	0.8 to 3.5	±30 mV	-	○	○			○	○	G	
PQ035ZN1HZPH				○					○	○			○	○	G	
★PQ035ZM02ZPH	Minimum operating input voltage: 1.1 V (Dual power supply type), ceramic capacitor compatible, solder dip compatible lead shape			○ (2 A)	8	1.5 to 20	±2.0 <sup>*3</sup>	±2.0	0.3	○	○			○	G	
PQ20VZ51J00H	Minimum operating input voltage: 4.5 V	○						24	3.0 to 20	±2.5 <sup>*3</sup>	0.5	○	○	○	○	○
PQ20VZ11J00H			○		○	○	○					○	○	○	F	
PQ20WZ51J00H	Minimum operating input voltage: 3.5 V, ASO protection function, low dissipation current at OFF state (I <sub>qs</sub> : 5 μA (MAX.))	○			24	3.0 to 20	±2.5 <sup>*3</sup>	0.5	○	○	○	○	○	○	F	
PQ20WZ11J00H			○						○	○	○	○	○	○	F	
PQ200WNA1ZPH	Minimum operating input voltage: 3.5 V, ASO protection function, low dissipation current at OFF state (I <sub>qs</sub> : 5 μA (MAX.)) ceramic capacitor compatible, solder dip compatible lead shape			○	24	3.0 to 20	±2.5 <sup>*3</sup>	0.5	○	○	○	○	○	○	G	
PQ200WN3MZPH	Minimum operating input voltage: 3.5 V, low dissipation current at OFF state (I <sub>qs</sub> : 5 μA (MAX.)), ceramic capacitor compatible, current limit: 800 mA	○ (0.3)							6.8	5.0 to 20			○	○		○

\*1 With infinite heat sink attached

\*2 The xx/xxx in the model No. refer to the output voltage values of the model (e.g. 033 for 3.3 V, 05/050 for 5 V, 12/120 for 12 V).

\*3 Reference voltage accuracy \*4 The value is defined as ± 50 mV in some models. \*5 Current ratings are defined individually. \*6 Refer to page 65



## ●TO-263 type

(Ta = 25°C)

Model No.	Features	Absolute maximum ratings			Electrical characteristics			Built-in functions					Taped package	Package	
		Output current I <sub>o</sub> (A)	Input voltage V <sub>in</sub> (V)	Power dissipation P <sub>d</sub> * <sup>1</sup> (W)	Output voltage V <sub>o</sub> * <sup>2</sup> (V) TYP.	Output voltage precision (%)	Dropout voltage V <sub>i-o</sub> * <sup>4</sup> (V)	Overheat protection	Overcurrent protection	ON/OFF control	Low dissipation current at OFF state	Variable output voltage			
PQxxY053ZPH	High output current (minimum operating input voltage : 2.35 V)	5.0	7	35	1.5, 2.5, 3.3	1.0	0.5	○	○	○	○	○	○	TO-263	
PQ05VY053ZPH					1.5 to 5	1.0* <sup>3</sup>		○	○	○	○	○			
PQxxY3H3ZPH		3.5			1.5, 2.5, 3.3	1.0		○	○	○	○	○			
PQ05VY3H3ZPH					1.5 to 5	1.0* <sup>3</sup>		○	○	○	○	○			
PQxxEH02ZPH	2 A output (minimum operating input voltage : 2.35 V)	2.0	10		1.5, 1.8, 2.5	±2.5		○	○	○	○	○	○		○
PQ070XH02ZPH					1.5 to 7	±2.0* <sup>3</sup>		○	○	○	○	○			
PQxxEH01ZPH	1 A output (minimum operating input voltage : 2.35 V)	1.0			1.5, 1.8, 2.5	±2.5		○	○	○	○	○	○		○
PQ070XH01ZPH					1.5 to 7	±2.0* <sup>3</sup>		○	○	○	○	○			

\*1 With infinite heat sink attached

\*2 The xxx in the model No. refer to the output voltage values of the model (e.g. 015 for 1.5 V, 025 for 2.5 V, 033 for 3.3 V).

\*3 Reference voltage accuracy

\*4 Current ratings are defined individually.

## ●SOP-8 type

(Ta = 25°C)

Model No.	Features	Absolute maximum ratings			Electrical characteristics		Built-in functions		Taped package	Package
		Output current I <sub>o</sub> (A)	Input voltage V <sub>in</sub> (V)	Power dissipation P <sub>d</sub> * (W)	Output voltage V <sub>o</sub> (V) TYP.	Output voltage precision (mV)	Overheat protection	Overcurrent protection		
PQ1DX095MZPQ	Built-in sink source function (For DDR II memory)	±0.8	6	0.6	V <sub>DD</sub> x 1/2 (V <sub>DDQ</sub> : 1.5 V (MIN.))	-	○	○	SOP-8	
PQ1DX125MZPQ	Built-in sink source function (For DDR memory)				V <sub>DD</sub> x 1/2 (V <sub>DDQ</sub> : 2.3 V (MIN.))	±35	○	○		○

\* When mounted on a board



★Under development



## ■ Surface Mount Type Chopper Regulators (DC-DC Converters)

(Ta = 25°C)

Model No.	Features	No. of output circuits	Output type			Built-in SW Tr	Input voltage range Vin (V)	Switch current Isw (A)	Output voltage Vo (V)	Oscillation frequency (Hz) TYP.	Package
			Step down	Step up	Inversion						
PQ6CU11X1APQ	<ul style="list-style-type: none"> <li>High voltage CMOS output : 30 V (MAX.)</li> <li>White LED driver for back light</li> <li>Output ON/OFF control function</li> <li>Overvoltage/overcurrent protection circuits</li> <li>Soft start function</li> </ul>			○	○	up to 5.5	0.25*1	—	1.2 M	SOT-23-6	
PQ6CB11X1AP	<ul style="list-style-type: none"> <li>High voltage CMOS output : 30 V (MAX.)</li> <li>White LED driver for back light (Capable of driving up to 4 LEDs in series connection)</li> <li>Output ON/OFF control function</li> <li>Overvoltage/overcurrent protection circuits</li> <li>Soft start function</li> </ul>			○	○	2.7 to 5.5		up to 30		USB-6	
PQ6CB11X1CP	<ul style="list-style-type: none"> <li>High voltage CMOS output : 30 V (MAX.)</li> <li>White LED driver for back light (Capable of driving up to 6 LEDs in series connection)</li> <li>Output ON/OFF control function</li> <li>Overvoltage/overcurrent protection circuits</li> <li>Soft start function</li> </ul>			○	○	2.7 to 5.5		up to 36	300 k to 800 k*7	SOT-23-6W	
PQ6CU12X2APQ	<ul style="list-style-type: none"> <li>High switching voltage : 40 V (MAX.)</li> <li>For tuner power supply</li> <li>Output ON/OFF control function</li> </ul>			○	○	3.0 to 5.5		up to 30	2 M	USB-10	
PQ7L2010BP	<ul style="list-style-type: none"> <li>Possible to correspond also to operation in the minute lighting mode</li> <li>High frequency PWM control for brightness adjustment</li> <li>Output ON/OFF control function</li> </ul>			○	○	2.7 to 5.5	0.8*1	from 0.8	Switchable between 2.0 M and 1.2 M	USB-6	
★PQ5CB11X1AP	<ul style="list-style-type: none"> <li>PWM chopper regulator</li> <li>Sleep mode function (by switching between PWM and PFM)</li> <li>Overvoltage/overcurrent protection circuits</li> <li>Soft start function</li> </ul>			○	○	2.7 to 5.5		VREF*2 to 35*5 (step-down type)/ -VREF*2 to -30*5 (inverting type)	300 k	100 k	SC-63
PQ1CZ38M2ZPH series	<ul style="list-style-type: none"> <li>PWM chopper regulator (high oscillation frequency)</li> <li>Output ON/OFF control function</li> <li>Overcurrent/overheat protection circuits</li> <li>For light load</li> </ul>			○	○	○	up to 40	1.5*1	300 k		
PQ1CZ21H2ZPH	<ul style="list-style-type: none"> <li>PWM chopper regulator</li> <li>Output ON/OFF control function</li> <li>Overcurrent/overheat protection circuits</li> <li>Low dissipation current at OFF state (Standby current &lt;I<sub>SD</sub>&gt; : 1 μA (MAX.))</li> </ul>	1		○	○	○	up to 33	2.5*1	150 k	SOP-8	
PQ1CZ41H2ZPH	<ul style="list-style-type: none"> <li>PWM chopper regulator (high oscillation frequency)</li> <li>Output ON/OFF control function</li> <li>Overcurrent/overheat protection circuits</li> </ul>			○	○	○	up to 28				1.5*1
PQ1CX12H2ZPQ	<ul style="list-style-type: none"> <li>Bootstrap system for high efficiency (Efficiency 90% (TYP.))</li> <li>Low dissipation current</li> </ul>			○	○	○	up to 40	3.5*1	150 k	TO-263	
PQ1CX22H2ZPQ	<ul style="list-style-type: none"> <li>Bootstrap system for high efficiency (Efficiency 90% (TYP.))</li> <li>Low dissipation current</li> <li>Low voltage output : 1.2 V (MIN.)</li> </ul>			○	○	○					VREF*2 to 35*5 (step-down type)/ -VREF*2 to -30*5 (inverting type)
★PQ1CX41H2ZPQ	<ul style="list-style-type: none"> <li>Bootstrap system for high efficiency (Efficiency 91% (TYP.))</li> <li>Low voltage output : 0.8 V (MIN.)</li> <li>Ceramic capacitor compatible</li> </ul>			○	○	○	up to 40	3.5*1	150 k	TO-263	
PQ1CY1032ZPH	<ul style="list-style-type: none"> <li>PWM chopper regulator</li> <li>Output ON/OFF control function</li> <li>Overheat protection/overcurrent shutdown circuits</li> <li>High output current type</li> </ul>			○	○	○	up to 40	3.5*1	150 k	TO-263	
PQ1CYxx3HZPH series PQ1CYxx3LZPH series	<ul style="list-style-type: none"> <li>PWM chopper regulator</li> <li>Fixed output voltage : 3.3 V or 5 V</li> <li>Output ON/OFF control function</li> <li>Overheat protection circuit</li> </ul>			○	○	○					3.3, 5.0*6 (TYP.)
IR3M18N	<ul style="list-style-type: none"> <li>Soft start function</li> <li>Undervoltage protection circuit</li> <li>Timer latch short-circuit protection circuit</li> <li>Standby function</li> </ul>			○			2.2 to 6.0	(Determined by external Tr)	100 k to 1 M*7	P-SSOP008-0150	
IR3M19N	<ul style="list-style-type: none"> <li>High transient load characteristics from built-in current control circuit</li> <li>Soft start function</li> <li>Overcurrent/overvoltage/undervoltage protection circuits</li> <li>Internal reference voltage accuracy (±1%)</li> </ul>			○	External		4.5 to 22	(Determined by external Tr)	1.24 to input voltage		220 k

\*1 Peak current (absolute maximum ratings) \*2 VREF nearly equal to 1.26 V (TYP.) \*3 VREF nearly equal to 1 V (TYP.) \*4 VREF nearly equal to 0.8 V (TYP.)  
 \*5 Output voltage variable range \*6 The xx in the model No. refer to the output voltage values of the model (e.g. 33 for 3.3 V, 50 for 5.0 V). \*7 Selectable oscillation frequency range

## ■ Surface Mount Type Chopper Regulators (DC-DC Converters) (cont'd)

(Ta = 25°C)

Model No.	Features	No. of output circuits	Output type			Built-in SW Tr	Input voltage range Vin (V)	Switch current Isw (A)	Output voltage Vo (V)	Oscillation frequency fo (Hz) TYP.	Package
			Step down	Step up	Inversion						
★IR3M56N	<ul style="list-style-type: none"> <li>High efficiency synchronous rectified step-down converter</li> <li>Current mode control</li> <li>Soft start function</li> <li>Overcurrent/overvoltage/undervoltage/overheat protection circuits</li> </ul>	1	○			External	4.5 to 36	(Determined by external Tr)	0.8 to 6.3	200 k/300 k/400 k/500 k/external sync.	P-TSSOP16-0225
IR3M17U	<ul style="list-style-type: none"> <li>Standby function (output ON/OFF control function for each channel)</li> <li>Soft start function</li> <li>Undervoltage protection circuit</li> </ul>	2	○	○		External	2.2 to 6.5	(Determined by external Tr)	0.8 to 6.3	100 k to 500 k*3/external sync.	P-HQFN020-0404
★IR3M57N	<ul style="list-style-type: none"> <li>High efficiency two channel synchronous rectified step-down converter</li> <li>Current mode control</li> <li>Soft start function</li> <li>Overcurrent/overvoltage/undervoltage/overheat protection circuits</li> </ul>		○				4.5 to 36			200 k/300 k/400 k/500 k/external sync.	
IR3M30M/U	<ul style="list-style-type: none"> <li>ON/OFF sequence setting</li> <li>Timer latch short-circuit protection circuit</li> <li>Soft start function</li> <li>Overcurrent/undervoltage/overheat protection circuits</li> </ul>	3	○	○		External	2.7 to 5.5	1*2 (when using internal Tr)	External setting	70 k to 1M*3	P-QFP048-0707/ P-VQFN036-0505
IR3M58M/U	<ul style="list-style-type: none"> <li>ON/OFF sequence setting without external control</li> <li>Timer latch phase fault protection circuit</li> <li>Soft start function</li> <li>Overcurrent/undervoltage/overheat protection circuits</li> </ul>		○	○	○						
			○	○	○	External setting					

\*1 Built-in SW Tr can be used in step-up mode ; external SW Tr is required in step-down or inverting mode.

\*2 Constant current (MAX.)

\*3 Selectable oscillation frequency range

## ■ Chopper Regulators (DC-DC Converters)

### ●TO-220 type

(Ta = 25°C)

Model No.	Features	Absolute maximum ratings			Electrical characteristics			Package	
		Switch current Isw (A)	Input voltage Vin (V)	Power dissipation Pd*1 (W)	Output voltage Vo*2 (V)	Oscillation frequency fo (kHz) TYP.	Output saturation voltage Vsat (V) TYP.		
PQ1CG38M2FZH	<ul style="list-style-type: none"> <li>PWM chopper regulator (high oscillation frequency)</li> <li>Built-in overcurrent/overheat protection circuits</li> <li>Output ON/OFF control function</li> <li>For light load</li> </ul>	0.8*3	40	14	VREF*4 to 35 (step-down type)/ -VREF*4 to -30 (inverting type)	300	0.9	TO-220	E
PQ1CG38M2RZH									D
PQ1CG21H2FZH	<ul style="list-style-type: none"> <li>PWM chopper regulator</li> <li>Built-in overcurrent/overheat protection circuits</li> <li>Output ON/OFF control function</li> </ul>	1.5*3	40	14	VREF*4 to 35 (step-down type)/ -VREF*4 to -30 (inverting type)	100	1.0		E
PQ1CG21H2RZH									D
PQ1CG41H2FZH	<ul style="list-style-type: none"> <li>PWM chopper regulator (high oscillation frequency)</li> <li>Built-in overcurrent/overheat protection circuits</li> <li>Output ON/OFF control function</li> </ul>	1.5*3	40	14	VREF*4 to 35 (step-down type)/ -VREF*4 to -30 (inverting type)	300	0.9		E
PQ1CG41H2RZH									D
PQ1CG2032FZH	<ul style="list-style-type: none"> <li>PWM chopper regulator</li> <li>Built-in overcurrent/overheat protection circuits</li> <li>Output ON/OFF control function</li> </ul>	3.5*3	40	14	VREF*4 to 35 (step-down type)/ -VREF*4 to -30 (inverting type)	70	1.4		E
PQ1CG2032RZH									D
PQ1CG3032FZH	<ul style="list-style-type: none"> <li>PWM chopper regulator (high oscillation frequency)</li> <li>Built-in overcurrent/overheat protection circuits</li> <li>Output ON/OFF control function</li> </ul>	3.5*3	40	14	VREF*4 to 35 (step-down type)/ -VREF*4 to -30 (inverting type)	150	1.4		E
PQ1CG3032RZH									D
PQ2CF1J0000H	<ul style="list-style-type: none"> <li>PWM chopper regulator</li> <li>Built-in overcurrent/overheat protection circuits</li> </ul>	2.5*3	35	15	4.5 to 35 (step-up type)	50	0.6	E	

\*1 With infinite heat sink attached \*2 Output voltage variable range \*3 Peak current \*4 VREF nearly equal to 1.26 V (TYP.) \*5 Refer to page 65

**Power Supply ICs for CCDs/CCD Camera Modules**

Model No.	No. of output circuits	Input voltage range (V)	Output voltage (V)	System	Switching frequency (Hz)	SW Tr	Switching current (mA) [Built-in SW Tr]	Drive capacity (pF) [External SW Tr]	Package
IR3M52Y7	5	2.7 to 5.5	15	Step-up type PWM + REG	1 M	Built-in	20 (DC)	–	41WL-CSP*2
			–8	Inverting type PWM		External	–	1 000	
			2.5 to 3.3	REG	–	–	100 (DC)	–	
			2.5 to 3.3	REG			100 (DC)	–	
			1.8/1.2	REG			100 (DC)	–	
IR3M61U*1/63U	4	4.5 to 10	15	Charge pump	200 k	–	1.2 (DC)	–	P-VQFN032-0505
			–8	Negative charge pump			2.5 (DC)	–	
			3.3	Step-down type PWM + REG	1 M	Built-in	120 (DC)	–	
			1.8	Step-down type PWM + REG			50 (DC)	–	
IR3M49U6	4	2.7 to 5.5	15	Step-up type PWM + REG	1 M	Built-in	600 (DC)	–	P-VQFN036-0505
			External setting	Step-up, step-down, step-up/down type PWM		External	–	1 000	
				Inverting type PWM	External	–	1 000		
IR3M55U*1/59U	3	4.5 to 16	15/12	Charge pump	200 k	–	10/20 (DC)	–	P-VQFN032-0505
			–8/–5	Negative charge pump			2/5 (DC)	–	
			3.3	Step-down type PWM + REG	1 M	Built-in	150 (DC)	–	
IR3M48U6	3	2.7 to 3.2	15	Charge pump + REG	300 k	–	6 (DC)	–	P-VQFN032-0505
			–8	Negative charge pump + REG			7 (DC)	–	
			1.8	REG	–	50 (DC)	–		

\*1 For automotive use

\*2 3.97 mm x 3.97 mm x 0.82 mm (TYP.)

**Power Supply ICs for TFT-LCDs**

Model No.	No. of output circuits	Input voltage range (V)	Output voltage (V)	System	Switching frequency (Hz)	SW Tr	Switching current (mA) [Built-in SW Tr]	Drive capacity (pF) [External SW Tr]	Package	
IR3M58M/U	3	4.5 to 28	External setting	Step-up (20 V (MAX.) ) / step-down type PWM	70 k to 500 k	Built-in (Step-up type)	400	1 000	P-QFP048-0707/ P-VQFN036-0505	
				Step-down type PWM		External	–			
				Step-down, inverting type PWM		External	–			
IR3M30M/U	3	2.7 to 5.5	External setting	Step-up, step-down, step-up/down type PWM	70 k to 1 M	Built-in (Step-up type)	1 000	–	P-HQFN020-0404	
				Step-up, step-down, step-up/down, inverting type PWM		Built-in (Step-up type)	1 000	–		
				Step-up, step-down, step-up/down, inverting type PWM		External	–	1 000		
IR3M16U	3	2.6 to 3.6	External setting	15.3	100 k	–	0.1 (DC)	–	P-HQFN020-0404	
				5.1		Charge pump + REG	–	5 (DC)		–
				–10.2		Negative charge pump	–	0.1 (DC)		–



■ Fail Safe IC

Model No.	Features	Operating voltage			Dissipation current (μA)	Operating temp. (°C)
		VBAT (V)	VBAC (V)	VIO (V)		
IR3T46U/46U6*	<ul style="list-style-type: none"> <li>Malfunction detection</li> <li>Built-in 8-bit ADC</li> <li>Built-in timer circuit</li> <li>Built-in key detection output OR gate</li> </ul>	3.2 to 4.5	3.0 to 3.3	2.6 to 3.0	TYP. 10	-20 to +85

\* 46U: Tray package  
46U6: Taped package

■ LED Drivers

● Built-in step up circuit

Model No.	Function	Features	No. of output circuits	Number of LEDs	Booster method	Built-in constant current circuit	Built-in SW Tr	Input voltage range (V)	Output current*1 (mA) MAX.	Oscillation frequency (Hz) TYP.	Package
PQ6CU11X1APQ	White LED driver for back light (for small panels)	<ul style="list-style-type: none"> <li>High voltage CMOS output: 30 V (MAX.)</li> <li>Output ON/OFF control function</li> <li>Overshoot/overcurrent protection circuits</li> <li>Softstart function</li> </ul>	1	3 (Series connection)	PWM	*1	○	to 5.5	250*2	1.2 M	SOT-23-6
PQ6CB11X1AP				4 (Series connection)		*1	○	2.7 to 5.5			USB-6
PQ6CB11X1CP				6 (Series connection)		*1	○				
PQ7L2010BP		<ul style="list-style-type: none"> <li>Possible to correspond also to operation in the minute lighting mode</li> <li>High frequency PWM control for brightness adjustment</li> <li>Output ON/OFF control function</li> </ul>		4 (Series connection)		*1	○	2.0 M		USB-10	
IR2E46Y6	RGB LED driver for picture lights and illuminations	<ul style="list-style-type: none"> <li>I<sup>2</sup>C bus control</li> <li>Illumination mode (64 levels/ch)</li> <li>Picture light mode (32 levels/ch)</li> <li>Brightness adjustment</li> <li>Standby function/soft start function</li> <li>Overcurrent/undervoltage/overheat protection circuits</li> </ul>	3	3	PWM	○	○	2.7 to 4.5	155/ch (in picture light mode)	1.2 M	33WL-CSP*4
IR2E47U6	White LED driver for back light (for small panels)	<ul style="list-style-type: none"> <li>Independent current control for two systems (4 outputs and 2 outputs)</li> <li>LED non-connected judging function</li> <li>Brightness adjustment</li> <li>Undervoltage/overheat protection circuits</li> </ul>	6	4 + 2	Charge pump	○	-	2.7 to 5.5	20/ch	1 M	P-HQFN024-0404
IR2E49U	White LED driver for back light (for medium panels)	<ul style="list-style-type: none"> <li>Built-in 150 mA driver for each channel</li> <li>Step-up DC-DC output short-circuit protection function</li> <li>Current driver output open detection</li> <li>Capable of external brightness adjustment using PWM input signal</li> <li>Overcurrent/overvoltage/undervoltage/overheat protection circuits</li> </ul>	5	40	PWM	○	External	6 to 28	150/ch*2	100 k to 1 M*3	P-VQFN036-0606
IR2E51Y6	LED driver for back light and call alert display LED driver (auto brightness adjustment)	<ul style="list-style-type: none"> <li>Capable of direct connection of ambient light sensor</li> <li>Brightness adjustment by ambient illuminance feedback (16-step ambient illuminance/128-level illuminance) (for main LCDs)</li> <li>Non-external coil thanks to charge pump drive</li> <li>Capable of driving 4 main-LEDs, 2 sub-LEDs, and 3 call alert LEDs with a single device.</li> <li>I<sup>2</sup>C interface</li> <li>Standby function/power on reset function/soft start function</li> </ul>	9	4 + 2 + 3	Charge pump	○	-	3.0 to 4.5 (for drive)/ 2.3 to 3.2 (for control)	25/ch	660 k	35WL-CSP*4

\*1 Constant current (MAX.)

\*2 Use this IC within the range of power dissipation.

\*3 Selectable oscillation frequency range

\*4 3.57 mm x 3.57 mm x 0.82 mm (TYP.)



● External power supply for LEDs

Model No.	Function	Features	Supply voltage (V)	Package
IR2D20U	24-dot LED panel driver with constant-current sink outputs	<ul style="list-style-type: none"> <li>• Output current (constant current sink output) : 30 mA (MAX.) (setup by external resistor)</li> <li>• Gradation function (clock cycle setting or external synchronization)</li> <li>• Independent current control for three systems (for RGB LED)</li> <li>• LED drive voltage : 15 V</li> <li>• Rated output voltage : 20 V (MAX.)</li> <li>• f<sub>CLK</sub> : 20 MHz (MAX.)/16.6 MHz (MAX.) (at cascade connection)</li> </ul>	4.5 to 5.5	P-HQFN052-0707
IR2D071	16-dot LED panel driver with constant current sink outputs	<ul style="list-style-type: none"> <li>• Output current (constant-current sink output) : 60 mA (MAX.) (setup by external resistor)</li> <li>• Rated output voltage : 7 V (MAX.)</li> <li>• f<sub>CLK</sub> : 20 MHz (MAX.)/16.6 MHz (MAX.) (at cascade connection)</li> </ul>	3.0 to 5.5	P-SDIP028-0400

■ Laser Diode Drivers

Model No.	Application	Function	Drive mode	Maximum output current (mA) MIN.	Applicable SHARP diode type	Supply voltage (V)	Package
IR3C14N1	For Mini Disc players	Built-in 100 mA driver, APC function	DC mode	100	—	2.4 to 3.5	P-SSOP008-0150
IR3C22N	For CD/DVD players	Built-in APC function, with inhibit input pin	—	150	P (Single power supply)	4.5 to 5.5	

☆New product  
★Under development



## Video Interface ICs for TFT-LCDs

Model No.	Input signal				Color decode	LCD panel				Serial data control	Supply voltage (V) TYP.	Power consumption (mW) TYP.	Package
	Composite video	Y/color difference	Analog RGB	OSD (Digital)		± power source	+ power source	Low voltage source	Digital input				
IR3Y18A1	○				NTSC/PAL	○	○				4.5/12 or 4.5/-7.5	130	P-QFP048-0707
IR3Y26A2/A6			○*3		-			○			5/7.5	140	P-QFP048-1010/ P-QFP048-0707
IR3Y29A1/B1	○		○		NTSC/PAL			○				190	
IR3Y31M1	○		○		NTSC/PAL	○	○				4.5/12 or 4.5/-7.5	160	
IR3Y34M1		○	○	○	-		○				3/12	88	
IR3Y37A1		○(Common terminal)		○	-			○			3/6.5	106/88*5	P-QFP048-0707
RB5P0010M2			○*3	○	-	○	○			○	3/12 or 3/4.5/-7.5	92	
RB5P0020M2		○(Common terminal)		○	-			○			3/5	70/57*5	
RB5P0050M2		○(Common terminal)		○	-			○		○		95/80*5	
RB5P0060M2	○		○		NTSC/PAL			○		○	3/5/13	120	P-QFP048-1010
RB5P006AM2	○		○		NTSC/PAL			○		○			
RB5P0070M*1	○		○	○	NTSC/PAL				○	○	3/7	330	P-QFP072-1010
RB5P0090M	○		○*3		NTSC/PAL (automatic identification)			○		○	5/13	250	P-QFP048-1010
LRS5751*2	○		○		NTSC/PAL			○			3.3/5/7.5	197	P-LQFP100-1414
LRS5752*2	○		○*3		NTSC/PAL (automatic identification)			○		○	3.3/5/13	257	
☆IR3Y63M	○	○	○*4	○ (Built-in)	NTSC/PAL/SECAM			○		○	3.3/5	300	P-TQFP100-1414

\*1 For digital signal input panels \*2 Built-in timing generator \*3 Two inputs \*4 Digital RGB input is also available. \*5 At analog input for RGB

## Power Amplifiers for Wireless LAN

Model No.	Application	Operating frequency (GHz)	Supply voltage (V) TYP.	Output power (dBm) TYP.	Supply current (mA) TYP.	Gain (dB) TYP.	Detection function	Matching circuit	Package
IRM046U7	For 2.4 GHz wireless LAN (IEEE 802.11b/g)	2.4 to 2.5	3.3	18 (at EVM 3%)	105	30	○	-	P-HQFN024-0404
	For 5 GHz wireless LAN (IEEE 802.11a)	4.9 to 5.9		18 (at EVM 2%)	140	25	○	-	
★IRM065U7	For 2.4 GHz wireless LAN (IEEE 802.11b/g)	2.4 to 2.5		18 (at EVM 3%)	130	29	○	Built-in (IN/OUT)	P-HQFN016-0303
	For 5 GHz wireless LAN (IEEE 802.11a)	4.9 to 5.9		18 (at EVM 3%)	160	30	○	Built-in (IN/OUT)	
IRM047U7	For 2.4 GHz wireless LAN* (IEEE 802.11b/g)	2.4 to 2.5		18 (at EVM 3%)	105	30	○	-	P-HQFN024-0404
★IRM060U7	For 2.4 GHz wireless LAN (IEEE 802.11b/g)			16 (at EVM 2%)	75	28	○	Built-in (IN/OUT)	P-HQFN010-0202A
IRM063U7				18 (at EVM 3%)	120	30	○	Built-in (IN/OUT)	
IRM048U7				140	25	○	-	P-HQFN024-0404	
★IRM053U7	For 5 GHz wireless LAN (IEEE 802.11a)	4.9 to 5.9		18 (at EVM 2%)	150	31	○	Built-in (IN/OUT)	P-HQFN010-0202A

\* Can be used as a power amp for PHS and DECT (1.9 GHz band), or as a driver amp for FWA (1.9 to 2.6 GHz band).



### ■ ICs for Audio Equipment

Model No.	Description	Function	Supply voltage (V)	Package
IR3R55M1	RF amp IC for Mini Disc players	Built-in RF amp, ADIP detection circuit, connectable to hologram pickup	2.4 to 3.3	P-TQFP048-0707
IR3R58M1		Built-in 2x speed RF amp, ADIP detection circuit, connectable to hologram pickup		
IR3R59N1	Audio amp IC	Built-in serial control input ATT and filter amp	$\pm 1.2$ to $\pm 3.25$	P-SSOP024-0275
IR3C14N1	Laser diode driver for Mini Disc players	Built-in 100 mA driver, APC function	2.4 to 3.5	P-SSOP008-0150





■ CSP

● CSP (Chip Size Package)

The FBGA (commonly known as CSP) has an area array terminal structure with solder balls on the bottom, to give it a near chip-size footprint. This high-density, compact and low-profile package technology will greatly help in the design of compact mobile equipment, such as mobile phones and digital cameras.



FBGA (CSP)

Features

- **Compact and lightweight**  
Ability to create a near-chip size and lighter-weight package in comparison with conventional plastic packages.
- **High reliability**  
Comparable high reliability with that of conventional plastic packages.
- **Mountability**  
Conventional mounting system is available for CSP. SOP and QFP can be mounted together with CSP.

Terminal pitch	0.8 mm	0.65 mm	0.5 mm	0.4 mm
Maximum terminal counts	288 (16 mm x 16 mm)	352 (16 mm x 16 mm)	424 (14 mm x 14 mm)	264 (10 mm x 10 mm)
Nominal dimensions	6 mm x 6 mm to 16 mm x 16 mm			5 mm x 5 mm to 10 mm x 10 mm

Cross section example

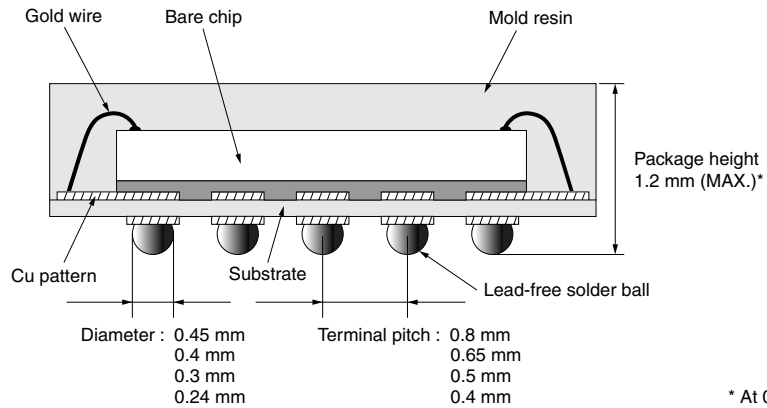

\* At 0.8 mm terminal pitch

● Wafer-level CSP

The wafer-level CSP (WL-CSP) is a kind of chip-size package which is manufactured by assembling directly onto the finished wafer.

Features

- **Compact and thinner size**  
It makes it possible to create an almost bare-chip-size and lighter-weight package.
- **Mountability**  
The conventional CSP mounting system can be also used in that of wafer-level CSP, which facilitates chip mounting more than bare-chip mounting does. It can be mounted together with other existing packages and passive components. (The use of underfill is recommended to improve the reliability of assembly.)

Chip size*	4 mm x 4 mm		3.5 mm x 3.5 mm		3 mm x 3 mm		2.5 mm x 2.5 mm	
Pad pitch	0.5 mm	0.4 mm	0.5 mm	0.4 mm	0.5 mm	0.4 mm	0.5 mm	0.4 mm
Maximum terminal counts	49 (7 x 7)	81 (9 x 9)	36 (6 x 6)	49 (7 x 7)	25 (5 x 5)	36 (6 x 6)	16 (4 x 4)	25 (5 x 5)

\* Rectangular chip form is also available.

Cross section example

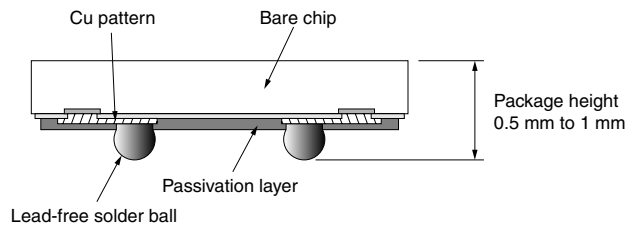



■ LGA

● LGA (Land Grid Array Package)

The LGA package has basically the same structure as the CSP, enabling a thin package by removing the solder balls from the bottom of the package. The LGA package contributes to the compact and thinner design of applications, such as mobile phones and digital cameras.

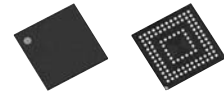

<b>Features</b>	<ul style="list-style-type: none"> <li>● <b>Lower package height</b> Achieves 0.5 mm Max. in package height.</li> <li>● <b>High reliability</b> Comparable high reliability with that of conventional plastic package.</li> <li>● <b>Excellent mountability</b> Conventional mounting system is available for LGA. SOP and QFP can be mounted together with LGA.</li> </ul>					
	<table border="1"> <tr> <td>Terminal pitch</td> <td>0.5 mm</td> </tr> <tr> <td>Maximum terminal count</td> <td>216 (10 mm x 10 mm)</td> </tr> <tr> <td>Nominal dimensions</td> <td>6 mm x 6 mm ~ 10 mm x 10 mm</td> </tr> </table>	Terminal pitch	0.5 mm	Maximum terminal count	216 (10 mm x 10 mm)	Nominal dimensions
Terminal pitch	0.5 mm					
Maximum terminal count	216 (10 mm x 10 mm)					
Nominal dimensions	6 mm x 6 mm ~ 10 mm x 10 mm					

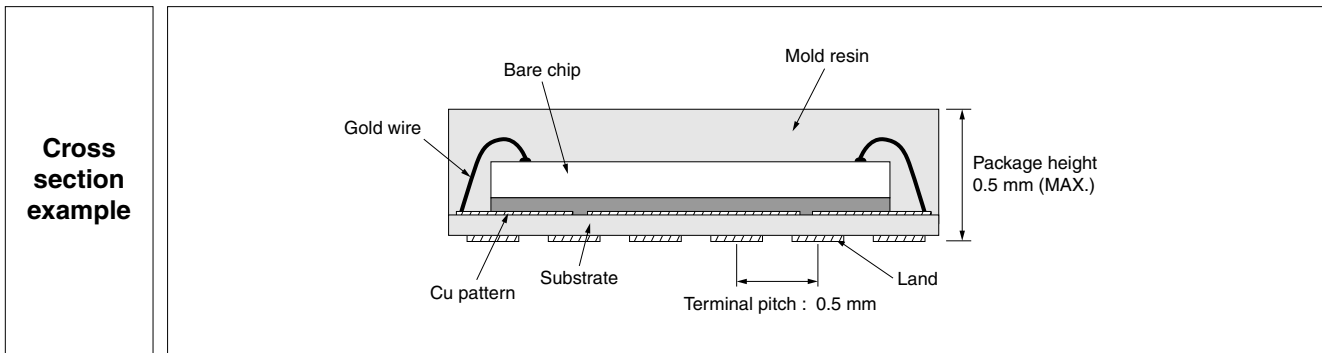



## ■ SiP (System in Package)

System in Package is an original SHARP high-density mounting technology that achieves high-density memory capacity and multiple functions by stacking multiple bare chips or multiple packages. This technology has two major streams. One method refers to a chip-stacked package technology that can achieve up to 5-chip mounting by stacking chips in a single package. The other method refers to a package stack technology with which it is possible to stack a package of over 5 chips, by stacking multiple packages in which 1 to 2 chips are stacked. The System in Package technology contributes to higher functionality of applications, such as mobile phones and digital cameras, as well as to reduction in size and weight.

### ● Chip Stacked CSP

<p><b>Features</b></p>	<ul style="list-style-type: none"> <li>● <b>Wide variety of lineup</b> It is possible to provide a wide lineup of stacked CSPs, including 2-chip, 3-chip, 4-chip and 5-chip stacked CSPs, to respond to customer needs.</li> <li>● <b>Compact and thinner size</b> Encapsulating multiple bare chips into an existing plastic package contributes to decreasing the mounting area. In addition, SHARP's wafer thinning technology makes it possible to achieve 1.4 mm package height.</li> <li>● <b>Multiple functions</b> Multiple bare chips of different sizes and functions, such as logic LSIs and memories, can be incorporated in a single package, making possible multiple functions.</li> <li>● <b>Same-size chip stacking technology</b> SHARP's stacking technology enables stacking of multiple same-size bare chips, contributing to higher memory density.</li> </ul> <p><b>(4-chip stacked CSP)</b> When using a SHARP four-chip stacked CSP, the mounting area and weight of a package can be decreased by half in comparison with using two 2-chip stacked CSPs, or a 3-chip stacked CSP and a conventional CSP.</p>
<p><b>Cross section example</b></p>	<p>(5-chip stacked CSP)</p> <p style="text-align: right;">* At 0.8 mm terminal pitch</p>

### ● Chip Stacked TSOP/QFP\*/VQFN/HQFN

<p><b>Features</b></p>	<ul style="list-style-type: none"> <li>● <b>Decreased mounting area</b> By encapsulating two identical or different types of bare chips into a single conventional plastic package, the mounting area of the package can be decreased.</li> <li>● <b>Multiple functions</b> Thanks to the incorporation of different sizes and functions of multiple bare chips, such as logic LSIs and memories, the functionality increases.</li> <li>● <b>Higher memory density</b> When incorporating two identical memory bare chips into a single package, memory density doubles on the same mounting area.</li> </ul>
<p><b>Cross section example</b></p>	

\* Including TQFP and LQFP.



## ● Package Stacked

### Features

- **Multi stacking**

The package stacking technology makes it possible to increase the memory capacity and create a combined system with memory and logic LSI. In the case of combination memories, memory capacity can be increased by stacking multiple 0.5 mm height packages in which 1 to 2 chips are stacked.

- **Decreased mounting area and height**

The package stacked technology makes it possible to decrease the mounting area by stacking multiple packages in which 1 to 2 chips are stacked, also achieving 1.5 mm height when six chips are stacked.

- **Multiple functions**

Thanks to the combination of packages in which various kinds of LSIs are mounted, such as a memory and ASIC, achieving an increase in and enhancement of functionality is easy.

### Cross section example

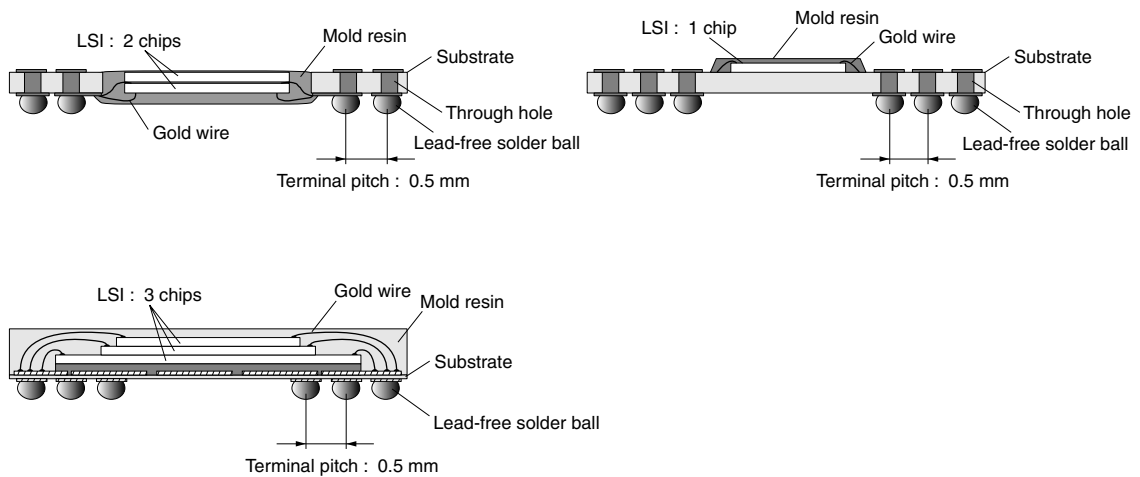

#### Examples of 3D-SiP composition

- High-density combination memory (3-package stacking)

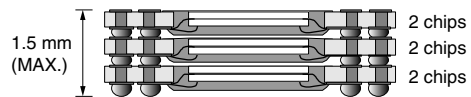
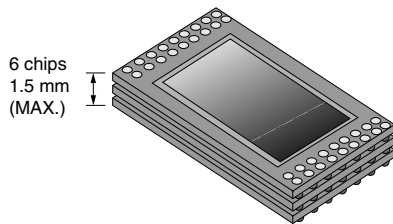

- System LSI (Logic LSI + Memory) (2-package stacking)

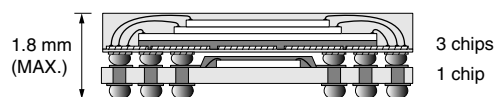
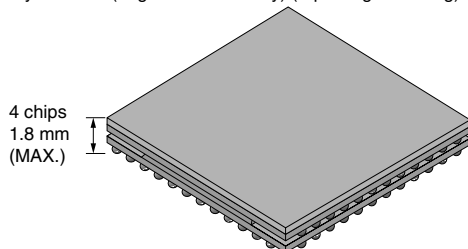



## ■ SOF

### ● SOF (System On Film)

SOF is a highly flexible thin film package, created from SHARP's TCP technologies. It can be easily bent, and contributes to thin and compact design of products. Peripheral circuit components can also be mounted.

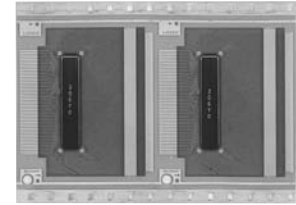

<p><b>Features</b></p>	<ul style="list-style-type: none"> <li>● <b>Highly flexible and thin film package</b> By using highly flexible and thin film, SOF contributes to creating thin and compact products. It can also achieve finer terminal pitches and multiple outputs easily, and pattern layout on a film under the chip makes it possible to improve the flexibility of the pattern layout.</li> <li>● <b>Multiple chip mounting</b> Plural bare chip mounting and incorporation of peripheral components contribute to the higher functionality of products.</li> </ul>																																				
<p><b>Cross section example</b></p>	<p>Thickness 0.6 mm (MIN.) 1.0 mm (TYP.)</p>																																				
<p><b>Film specifications</b></p>	<table border="1"> <tr> <td>Film width : <math>W_1</math></td> <td>35 mm super wide</td> <td>48 mm super wide</td> <td>70 mm wide</td> </tr> <tr> <td>Maximum pattern layout area : <math>W_2</math></td> <td>28.6 mm</td> <td>41.6 mm</td> <td>59.0 mm</td> </tr> <tr> <td>Maximum device pitch : L</td> <td colspan="3">15 sprockets</td> </tr> <tr> <td>Copper foil thickness</td> <td colspan="3">8 <math>\mu</math>m</td> </tr> <tr> <td>Copper foil type</td> <td colspan="3">Rolled or electrolytic</td> </tr> <tr> <td>Copper foil plating</td> <td colspan="3">Tin (Sn)</td> </tr> <tr> <td>Minimum pattern pitch</td> <td colspan="3">0.029 mm</td> </tr> <tr> <td>Sprocket hole : A</td> <td colspan="3">1.981 mm (wide) / 1.42 mm (super wide)</td> </tr> <tr> <td>Sprocket hole : B</td> <td colspan="3">1.981 mm (wide) / 1.42 mm (super wide)</td> </tr> </table> 	Film width : $W_1$	35 mm super wide	48 mm super wide	70 mm wide	Maximum pattern layout area : $W_2$	28.6 mm	41.6 mm	59.0 mm	Maximum device pitch : L	15 sprockets			Copper foil thickness	8 $\mu$ m			Copper foil type	Rolled or electrolytic			Copper foil plating	Tin (Sn)			Minimum pattern pitch	0.029 mm			Sprocket hole : A	1.981 mm (wide) / 1.42 mm (super wide)			Sprocket hole : B	1.981 mm (wide) / 1.42 mm (super wide)		
Film width : $W_1$	35 mm super wide	48 mm super wide	70 mm wide																																		
Maximum pattern layout area : $W_2$	28.6 mm	41.6 mm	59.0 mm																																		
Maximum device pitch : L	15 sprockets																																				
Copper foil thickness	8 $\mu$ m																																				
Copper foil type	Rolled or electrolytic																																				
Copper foil plating	Tin (Sn)																																				
Minimum pattern pitch	0.029 mm																																				
Sprocket hole : A	1.981 mm (wide) / 1.42 mm (super wide)																																				
Sprocket hole : B	1.981 mm (wide) / 1.42 mm (super wide)																																				
<p><b>Other components</b></p>	<p>Bare chips and peripheral circuit components can be mounted on the film.</p>																																				

In addition to the SOF described above, a conventional TCP (Tape Carrier Package) is also available.

## ■ Package Lineup

### ● Surface-mount Type

Package type	Appearance (Package material)	Package code	No. of terminals	Terminal pitch mm	Nominal dimensions mm	Package width & length x (seated height [MAX.]) mm		
FBGA (CSP)		LFBGA048-0606		0.8	6 x 6	6.0 x 6.0 x (1.4)		
		TFBGA048-0608	48		6 x 8	6.0 x 8.0 x (1.2)		
		TFBGA048-0808			8 x 8	8.0 x 8.0 x (1.2)		
		TFBGA056-0808	56					
		TFBGA060-0811	60 (48)*					
		TFBGA064-0811	64			8 x 11	8.0 x 11.0 x (1.2)	
		TFBGA072-0811						
		LFBGA072-0811	72 (64)*				8.0 x 11.0 x (1.4) / (1.6)	
		TFBGA081-0808	81			8 x 8	8.0 x 8.0 x (1.2)	
		LFBGA085-0811	85					
		LFBGA087-0811	87			8 x 11	8.0 x 11.0 x (1.4) / (1.6)	
		LFBGA088-0811						
		LFBGA088-0912	88			9 x 12	9.0 x 12.0 x (1.4) / (1.6)	
		LFBGA090-0811	90			8 x 11	8.0 x 11.0 x (1.4) / (1.6)	
		TFBGA096-1010	96			10 x 10	10.0 x 10.0 x (1.2)	
		LFBGA107-0912	107			9 x 12	9.0 x 12.0 x (1.4) / (1.6)	
		TFBGA111-1010	111					
		TFBGA112-1010	112			10 x 10	10.0 x 10.0 x (1.2)	
		LFBGA115-0914	115			9 x 14	9.0 x 14.0 x (1.4) / (1.6)	
		LFBGA116-1010	116			10 x 10	10.0 x 10.0 x (1.4) / (1.6)	
		LFBGA130-1013	130			10 x 13	10.0 x 13.0 x (1.4) / (1.6)	
		TFBGA144-1111	144			11 x 11	11.0 x 11.0 x (1.2)	
		TFBGA160-1212	160				12.0 x 12.0 x (1.2)	
		LFBGA168-1212	168				12.0 x 12.0 x (1.4) / (1.6)	
		TFBGA180-1212	180			12 x 12	12.0 x 12.0 x (1.2)	
		TFBGA184-1212	184					
		TFBGA240-1414	240			14 x 14	14.0 x 14.0 x (1.2)	
		LFBGA280-1616	280					
		★LFBGA352-1616	352			16 x 16	16.0 x 16.0 x (1.5)	
		TFBGA064-0606	64			0.65	6 x 6	6.0 x 6.0 x (1.2)
		LFBGA144-0909	140				9 x 9	9.0 x 9.0 x (1.4)
		LFBGA160-1010	160				10 x 10	10.0 x 10.0 x (1.4) / (1.6)
TFBGA180-1313	180		13 x 13	13.0 x 13.0 x (1.2)				
LFBGA192-1010	192		10 x 10	10.0 x 10.0 x (1.4) / (1.6)				
LFBGA208-1212	208		12 x 12	12.0 x 12.0 x (1.4) / (1.6)				
LFBGA224-1313	224			13.0 x 13.0 x (1.4) / (1.6)				
TFBGA260-1313	260		13 x 13	13.0 x 13.0 x (1.2)				

\* Figures in brackets indicate available terminal counts.

★Under development



## ●Surface-mount Type (cont'd)



Package type	Appearance (Package material)	Package code	No. of terminals	Terminal pitch mm	Nominal dimensions mm	Package width & length x (seated height [MAX.]) mm
FBGA (CSP)		LFBGA064-0606	64	0.5	6 x 6	6.0 x 6.0 x (1.1)
		TFBGA068-0606	68			6.0 x 6.0 x (0.9)
		VFBGA081-0606	81			6.0 x 6.0 x (1.1)
		TFBGA084-0606	84			6.0 x 6.0 x (0.9)
		VFBGA100-0606	100			7.0 x 7.0 x (0.9)
		VFBGA100-0707				7.0 x 7.0 x (1.1)
		TFBGA100-0707	108		7.0 x 7.0 x (0.9)	
		VFBGA108-0707			7.0 x 7.0 x (1.1)	
		TFBGA108-0707	120		7.0 x 7.0 x (0.9)	
		VFBGA120-0707			7.0 x 7.0 x (1.1)	
		TFBGA120-0707	144		8.0 x 8.0 x (0.9)	
		VFBGA144-0808			8.0 x 8.0 x (1.3) / (1.5)	
		LFBGA144-0808	152		8 x 11	8.0 x 11.0 x (1.3)
		TFBGA152-0808			8.0 x 8.0 x (1.1)	
		VFBGA171-0811	171		8 x 11	8.0 x 11.0 x (0.9)
		LFBGA171-0811				8.0 x 11.0 x (1.3) / (1.5)
		VFBGA176-0909	176		9 x 9	9.0 x 9.0 x (0.9)
		TFBGA176-0909	180			9.0 x 9.0 x (1.1)
		TFBGA180-0909	188		11 x 11	11.0 x 11.0 x (0.9)
		VFBGA188-1111			9 x 9	9.0 x 9.0 x (1.1)
		TFBGA188-0909	208		10 x 10	10.0 x 10.0 x (0.9)
		VFBGA208-1010				10.0 x 10.0 x (1.1)
		TFBGA208-1010	245		10 x 10	10.0 x 10.0 x (1.3)
		TFBGA245-1010				14.0 x 14.0 x (1.8)
		LFBGA245-1010	424		14 x 14	6.0 x 6.0 x (0.75)
		FBGA424-1414				6 x 6
WFBGA144-0606	144	0.4	7 x 7	7.0 x 7.0 x (1.0)		
★WFBGA121-0606	121		8 x 8	8.0 x 8.0 x (1.0)		
TFBGA168-0707	168					
TFBGA204-0808	204					

(Plastic)

★Under development



## ●Surface-mount Type (cont'd)

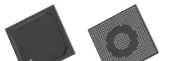





Package type	Appearance (Package material)	Package code	No. of terminals	Terminal pitch mm	Nominal dimensions mm	Package width & length x (seated height [MAX.] mm)	
FBGA (CSP)		TFBGAXXX-0606	to 36	0.8	6 x 6	6.0 x 6.0 x (1.2)	
		TFBGAXXX-0707	to 49		7 x 7	7.0 x 7.0 x (1.2)	
		TFBGAXXX-0808	to 81		8 x 8	8.0 x 8.0 x (1.2)	
		TFBGAXXX-0909	to 100		9 x 9	9.0 x 9.0 x (1.2)	
		TFBGAXXX-1010	to 121		10 x 10	10.0 x 10.0 x (1.2)	
		TFBGAXXX-1111	to 144		11 x 11	11.0 x 11.0 x (1.2)	
		TFBGAXXX-1212	to 196		12 x 12	12.0 x 12.0 x (1.2)	
		TFBGAXXX-1313	to 216		13 x 13	13.0 x 13.0 x (1.2)	
		TFBGAXXX-1414	to 240		14 x 14	14.0 x 14.0 x (1.2)	
		TFBGAXXX-1515	to 280		15 x 15	15.0 x 15.0 x (1.2)	
		TFBGAXXX-1616	to 280		16 x 16	16.0 x 16.0 x (1.2)	
		TFBGAXXX-0606	to 49		0.65	6 x 6	6.0 x 6.0 x (1.2)
		TFBGAXXX-0707	to 81			7 x 7	7.0 x 7.0 x (1.2)
		TFBGAXXX-0808	to 121			8 x 8	8.0 x 8.0 x (1.2)
		TFBGAXXX-0909	to 144			9 x 9	9.0 x 9.0 x (1.2)
		TFBGAXXX-1010	to 196			10 x 10	10.0 x 10.0 x (1.2)
		TFBGAXXX-1111	to 224	11 x 11		11.0 x 11.0 x (1.2)	
		TFBGAXXX-1212	to 256	12 x 12		12.0 x 12.0 x (1.2)	
		TFBGAXXX-1313	to 272	13 x 13		13.0 x 13.0 x (1.2)	
		TFBGAXXX-1414	to 304	14 x 14		14.0 x 14.0 x (1.2)	
		TFBGAXXX-1515	to 320	15 x 15		15.0 x 15.0 x (1.2)	
		TFBGAXXX-1616	to 352	16 x 16		16.0 x 16.0 x (1.2)	
		TFBGAXXX-0606	to 100	0.5		6 x 6	6.0 x 6.0 x (1.1)
		TFBGAXXX-0707	to 132			7 x 7	7.0 x 7.0 x (1.1)
		TFBGAXXX-0808	to 164			8 x 8	8.0 x 8.0 x (1.1)
		TFBGAXXX-0909	to 192			9 x 9	9.0 x 9.0 x (1.1)
		TFBGAXXX-1010	to 216			10 x 10	10.0 x 10.0 x (1.1)
		TFBGAXXX-1111	to 244		11 x 11	11.0 x 11.0 x (1.1)	
		TFBGAXXX-1212	to 268		12 x 12	12.0 x 12.0 x (1.1)	
		TFBGAXXX-1313	to 296		13 x 13	13.0 x 13.0 x (1.1)	
		TFBGAXXX-1414	to 320		14 x 14	14.0 x 14.0 x (1.1)	
		TFBGAXXX-1515	to 348		15 x 15	15.0 x 15.0 x (1.1)	
		TFBGAXXX-1616	to 372		16 x 16	16.0 x 16.0 x (1.1)	
		TFBGAXXX-0505	to 100		0.4	5 x 5	5.0 x 5.0 x (1.0)
		TFBGAXXX-0606	to 144			6 x 6	6.0 x 6.0 x (1.0)
		TFBGAXXX-0707	to 168			7 x 7	7.0 x 7.0 x (1.0)
TFBGAXXX-0808	to 204	8 x 8	8.0 x 8.0 x (1.0)				
TFBGAXXX-0909	to 228	9 x 9	9.0 x 9.0 x (1.0)				
TFBGAXXX-1010	to 264	10 x 10	10.0 x 10.0 x (1.0)				
FLGA (LGA)	 (Plastic)	XFLGA100-0707	100	0.5		7 x 7	7.0 x 7.0 x (0.5)
PBGA (BGA)		★PBGA0356-2121	356	1.0		21 x 21	21.0 x 21.0 x (2.2)
		PBGA0476-3535	476	1.27		35 x 35	35.0 x 35.0 x (2.63)
		PBGA0528-3535	528				

XXX: Terminal counts





## ●Surface-mount Type (cont'd)



Package type	Appearance (Package material)	Package code	No. of terminals	Terminal pitch mm (mil)	Nominal dimensions mm (mil)	Package width & length x (seated height [MAX.]) mm	Lead frame material	
							Alloy42	Copper alloy
SOP		P-SOP044-0600	44	1.27 (50)	15.2 (600)	13.2 x 28.2 x (3.1)	○	○
SSOP		P-SSOP008-0150	8	0.65	4.5 (150)	3.0 x 3.0 x (1.1)	-	○
		P-SSOP012-0225	12	0.75	5.7 (225)	4.4 x 5.0 x (1.8)	○	-
		P-SSOP024-0275	24	0.65	7.0 (275)	6.0 x 7.8 x (1.27)	-	○
		P-SSOP040-0300	40		7.6 (300)	6.3 x 13.5 x (1.8)	-	○
		P-SSOP070-0500	70	0.8	12.7 (500)	12.7 x 28.6 x (3.05)	-	○
MFP	P-MFP018	18	0.8	-	6.0 x 7.5 x (1.8)	○	-	
	P-MFP020	20	0.75	-	6.0 x 7.5 x (1.8)	○	-	
TSOP	 (Plastic)	P-TSOP040-1020	40	0.5	10 x 20	10.0 x 18.4 x (1.2)	○	○
		P-TSOP048-1220	48		12 x 20	12.0 x 18.4 x (1.2)	○	○
		P-TSOP056-1420	56		14 x 20	14.0 x 18.4 x (1.2)	○	○
QFP		P-QFP048-0707	48	0.5	7 x 7	7.0 x 7.0 x (1.65)	○	-
		P-QFP048-1010		0.75	-	10.0 x 10.0 x (1.82)	○	-
		P-QFP064-1010	64	0.5	10 x 10	10.0 x 10.0 x (1.8)	○	-
		P-QFP072-1010					72	○
		P-QFP128-1420	128	0.4	14 x 20	14.0 x 20.0 x (2.3)	○	-
		P-QFP156-1420	156				○	-
LQFP		P-LQFP080-1212	80	0.5	12 x 12	12.0 x 12.0 x (1.7)	○	-
		P-LQFP100-1414	100		14 x 14	14.0 x 14.0 x (1.7)	○	-
		P-LQFP144-2020	144		20 x 20	20.0 x 20.0 x (1.7)	-	○
		P-LQFP176-2424	176		24 x 24	24.0 x 24.0 x (1.7)	-	○
		★P-LQFP256-2828	256		28 x 28	28.0 x 28.0 x (1.7)	-	○
TQFP	 (Plastic)	P-TQFP048-0707	48	0.5	7 x 7	7.0 x 7.0 x (1.2)	○	-
		P-TQFP100-1414	100	0.4	14 x 14	14.0 x 14.0 x (1.2)	○	-
		P-TQFP128-1414	128				○	-
VQFN		P-VQFN020-0404	20	0.5	4 x 4	4.2 x 4.2 x (1.0)	-	○
		P-VQFN028-0505	28		5 x 5	5.2 x 5.2 x (1.0)	-	○
		P-VQFN032-0505	32		6 x 6	6.2 x 6.2 x (1.0)	-	○
		P-VQFN036-0606	36		7 x 7	7.2 x 7.2 x (1.0)	-	○
		P-VQFN048-0707	48	0.4	5 x 5	5.2 x 5.2 x (1.0)	-	○
		P-VQFN036-0505	36		7 x 7	7.2 x 7.2 x (1.0)	-	○
		P-VQFN052-0707	52		8 x 8	8.2 x 8.2 x (1.0)	-	○
		P-VQFN064-0808	64		8 x 8	8.2 x 8.2 x (1.0)	-	○
HQFN*	 (Plastic)	P-HQFN010-0202A	10	0.4	2 x 2	2.0 x 2.0 x (0.35)	-	○
		★P-HQFN010-0202B				2.2 x 2.2 x (0.35)	-	○
		★P-HQFN014-0202				14	2.2 x 2.2 x (0.55)	-
		P-HQFN016-0303	16	0.5	3 x 3	3.0 x 3.0 x (0.85)	-	○
		P-HQFN016-0404		0.65	4.0 x 4.0 x (1.0)	-	○	
		P-HQFN020-0404	20	0.5	4 x 4	4.0 x 4.0 x (0.85)	-	○
		P-HQFN024-0404	24			4.2 x 4.2 x (1.0)	-	○
		P-HQFN028-0505	28			5 x 5	5.0 x 5.0 x (1.0)	-
		P-HQFN052-0707	52	0.4	7 x 7	7.2 x 7.2 x (1.0)	-	○

\* HQFN is a higher heat dissipation package of VQFN.

100 mil = 2.54 mm

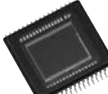
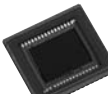

## ●For CCDs

Package type	Appearance (Package material)	Package code	No. of terminals	Terminal pitch mm	Nominal dimensions mm (mil)	Package width & length x (seated height) mm
DIP	 (Plastic)	P-DIP014-0400A	14	1.27	10.16 (400)	10.0 x 10.0
		P-DIP016-0500C	16	1.78	12.7 (500)	12.4 x 14.0
		P-DIP020-0400	20	1.00	10.16 (400)	10.0 x 10.0
	 (Ceramic)	N-DIP016-0450	16	1.27	11.43 (450)	11.4 x 12.2
		N-DIP016-0500C		1.78	12.7 (500)	12.4 x 14.0
SOP	 (Plastic)	P-SOP028-0400	28	0.69	10.16 (400)	10.0 x 10.0 x (3.5)
		P-SOP032-0525	32	0.78	13.3 (525)	12.0 x 13.8 x (3.9)
LCC	 (Ceramic)	N-LCC028-S450A	28	0.80	11.5	11.5 x 11.5 x (1.62)
		N-LCC032-R543	32	0.80	13.8	12.9 x 13.8 x (1.35)

100 mil = 2.54 mm

### Nominal dimensions

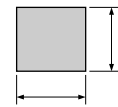

FBGA (CSP)  
FLGA (LGA)  
PBGA (BGA)

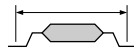

SOP  
SSOP  
MFP

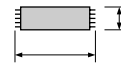

TSOP

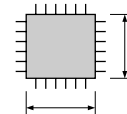

QFP  
LQFP  
TQFP

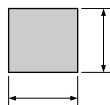

VQFN  
HQFN

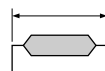

DIP









LCC

FBGA : fine-pitch ball grid array package  
FLGA : fine-pitch land grid array package  
PBGA : plastic ball grid array package  
SOP : small outline package  
SSOP : shrink small outline package  
MFP : mini flat package  
TSOP : thin small outline package

QFP : quad flat package  
LQFP : low profile quad flat package  
TQFP : thin quad flat package  
VQFN : very thin quad flat non-leaded package  
HQFN : heat sink quad flat non-leaded package  
DIP : dual inline package  
LCC : leadless chip carrier







## ●Lead-inserting Type Packages [For regulators: PQ series]

Package type	Appearance (Package material)	No. of terminals	Terminal pitch mm	Outline dimensions (Width x Thickness x Height) mm	Lead frame material
TO-220 (Heat sink exposure) [Lead forming type]	 (Plastic)	5	(1.7)* <sup>1</sup>	10.2 (MAX.) x 3.5 x 25.2* <sup>2</sup>	Cu
TO-220	 (Plastic)	4	2.54	10.2 (MAX.) x 4.5 x 29.1* <sup>2</sup>	Cu
TO-220 (Full mold)	 (Plastic)	4	2.54	10.2 (MAX.) x 4.5 x 29.1* <sup>2</sup>	Cu
TO-220 (Full mold) [Lead forming type]	 (Plastic)	5	(1.7)* <sup>1</sup>	10.2 (MAX.) x 4.5 x 24.6* <sup>2</sup>	Cu
TO-220 [Lead forming type]	 (Plastic)	5	(1.7)* <sup>1</sup>	10.2 (MAX.) x 4.5 x 24.6* <sup>2</sup>	Cu
TO-220 [Lead forming type]	 (Plastic)	5	(1.7)* <sup>1</sup>	10.2 (MAX.) x 4.5 x 24.6* <sup>2</sup>	Cu
TO-92	 (Plastic)	3	2.5	5.2 (MAX.) x 4.2 (MAX.) x 18.2 (MAX.)* <sup>2</sup>	Cu

\*1 The figure in parentheses indicates reference value.

\*2 Including lead length

## ●Surface-mount Type Packages [For regulators/LED drivers: PQ series]







Package type	Appearance (Package material)	No. of terminals	Terminal pitch mm	Outline dimensions (Width x Height x Thickness) mm	Lead frame material
TO-263	 (Plastic)	5 (Heat sink not included)	(1.7)* <sup>1</sup>	10.6 (MAX.) x 13.7 (MAX.)* <sup>2</sup> x 3.5	Cu
SC-63	 (Plastic)	5 (Heat sink not included)	(1.27)* <sup>1</sup>	6.6 (MAX.) x 9.7 (MAX.)* <sup>2</sup> x 2.3	Cu
SC-63	 (Plastic)	5 (Heat sink included)	(1.27)* <sup>1</sup>	6.6(MAX.) x 9.7 (MAX.)* <sup>2</sup> x 2.1	Cu
SOP-8	 (Plastic)	8	1.27	5 x 6.2* <sup>2</sup> x 1.55* <sup>2</sup>	Cu

\*1 The figure in parentheses indicates reference value.

\*2 Including lead length

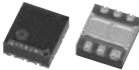

### ●Surface-mount Type Packages [For regulators/LED drivers: PQ series] (cont'd)

Package type	Appearance (Package material)	No. of terminals	Terminal pitch mm	Outline dimensions (Width x Height x Thickness) mm	Lead frame material
SOT-89	 (Plastic)	6	1.5	4.5 x 4.3 <sup>*2</sup> x 1.5	Cu
SOT-23-6	 (Plastic)	6	0.95	2.9 x 2.8 <sup>*2</sup> x 1.3	Cu
SOT-23-6W	 (Plastic)	6	0.95	2.9 x 2.8 <sup>*2</sup> x 1.3	Cu
SOT-23-L	 (Plastic)	6	(0.95) <sup>*1</sup>	(3.4) <sup>*1</sup> x 3.3 <sup>*2</sup> x 1.4 (MAX.)	Cu
SOT-23-5	 (Plastic)	5	(0.95) <sup>*1</sup>	(2.9) <sup>*1</sup> x 2.8 <sup>*2</sup> x 1.3 (MAX.)	Cu
USB-6		6	0.5	2.0 x 1.8 x 0.8	Cu (Terminal material)/ Au plating (Terminal finish)
USB-10		10	0.5	2.8 x 2.0 x 0.8	—

\*1 The figure in parentheses indicates reference value.

\*2 Including lead length

The companies listed below own the trademarks of the relevant LSIs.

ARM, ARM7TDMI, ARM720T, ARM922T, ARM946E-S, ARM926EJ-S and Developer Suite are trademarks of ARM Ltd.  
 Windows is a trademark of Microsoft Corporation.  
 Ball Grid Array and BGA are trademarks of Motorola Nippon Ltd.  
 RSDS is a trademark of National Semiconductor Corporation.  
 Java and Java Card are trademarks of Sun Microsystems, Inc.  
 SmartMedia is a trademark of Toshiba Corporation.  
 Z80 is a trademark of ZILOG, Inc.  
 CompactFlash is a trademark of SanDisk Corporation.  
 MIPS, MIPS32, 4Ksd are trademarks of MIPS Technologies, Inc.  
 QUALCOMM and MSM are trademarks of QUALCOMM Incorporated.  
 IrSS and IrSimple are trademarks of Infrared Data Association®.  
 Bluetooth is a trademark of Bluetooth SIG, Inc.  
 All other product or company names are trademarks of their respective holders.



#### Notice

In the absence of confirmation by device specification sheets, SHARP takes no responsibility for any defects that may occur in equipment using any SHARP devices shown in catalogs, data books, etc. Contact SHARP in order to obtain the latest device specification sheets before using any SHARP device.



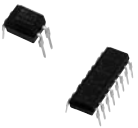

## ■ Photocoupler Lineup

### <Phototransistor output type>

Package type	Output type	Features	Model No. (series)	Page			
4-pin SOP Compact, SMT type 	Single phototransistor	General purpose, High collector-emitter voltage, etc.	PC35x series/PC451J0000F	68			
		AC input response	Low input current PC367NJ0000F	68			
		High sensitivity, High collector-emitter voltage	Low input current PC354NJ0000F	68			
	Darlington phototransistor	Single phototransistor	High collector-emitter voltage	PC364NJ0000F	68		
			AC input response	Low input current PC355NJ0000F	68		
			General purpose, High collector-emitter voltage, etc.	Low input current PC365NJ0000F	68		
Compact, Half pitch (lead space), SMT type 	Single phototransistor	General purpose, High collector-emitter voltage, etc.	PC3Hx series	69			
		AC input response	Low input current PC3H71xNIP0F	69			
		High collector-emitter voltage	PC4H510NIP0F	69			
		AC input response	PC3H3J00000F/PC3H4J00000F	69			
		4-channel output	Low input current PC3H41xNIP0F	69			
		AC input response	PC3Q62J0000F▲/PC3Q67QJ000F▲	69			
	Darlington phototransistor	Single phototransistor	AC input response	Low input current PC3Q71xNIP0F▲	69		
			4-channel output	PC3Q63J0000F▲/PC3Q64QJ000F▲	69		
			AC input response	Low input current PC3Q41xNIP0F▲	69		
		Darlington phototransistor	Single phototransistor	General purpose	PC3H5J00000F	69	
				High collector-emitter voltage	Low input current PC3H510NIP0F	69	
				4-channel output	PC4H520NIP0F▲	69	
			Darlington phototransistor	Single phototransistor	4-channel output	PC3Q65J0000F▲	69
					AC input response	Low input current PC3Q510NIP0F▲	69
					Isolation thickness: 0.4 mm or more Creepage distance: 6.4 mm or more	PC123J00000F series	70
DIP type (4/16-pin) 	Single phototransistor	Approved by safety standards other than UL	Low input current PC1231xNSZ0F	70			
		General purpose, High collector-emitter voltage, etc.	PC817XJ0000F/PC847XJ0000F/ PC851XJ0000F	70			
		AC input response	Low input current PC817xxNSZ0F	70			
		AC input response	PC814XJ0000F/PC844XJ0000F	70			
		Built-in SBD/High response speed	Low input current PC8141xNSZ0F	70			
	Darlington phototransistor	Single phototransistor	General purpose, High collector-emitter voltage	PC81100NSZ0F	70		
			General purpose, High collector-emitter voltage	PC815XJ0000F/PC845XJ0000F/ PC852XJ0000F/PC853XJ0000F	70		
			AC input response	Low input current PC81510NSZ0F	70		
			General purpose, High collector-emitter voltage, etc.	PC7xxV0NSZXF	71		
			Darlington phototransistor	General purpose, High collector-emitter voltage, etc.	PC7x5V0NSZXF	71	

### <OPIC output type>

Package type	Output type	Features	Model No. (series)	Page
Compact, SMT type 	Digital output	General purpose, High response speed, 2ch, etc.	PC4xxJ00000F/PC456L0NIP0F/ PC41xS0NIP0F/PC410L0NIP0F/ PC411L0NIP0F/PC4D10SNIP0F	72
	Analog/Digital output	High CMR	PC457S0NIP0F/PC457L0NIP0F	73
DIP type, SMT type 	Digital output	General purpose, High response speed, etc.	PC9xxV0NSZXF/PC956L0NSZ0F/ PC910L0NSZ0F/PC911L0NSZ0F/ PC912L0NSZ0F▲	73
	Built-in base amplifier	For inverter control/For inverter control, Built-in short-circuit protection circuit	PC928J00000F▲/PC929J00000F▲/ PC942J00000F/PC92xL0NSZ0F series	74
	Analog/Digital output	High speed, High CMR, etc.	PC957L0NSZ0F	74

The model marked with ▲ may not be available in the near future. Contact with SHARP for details before use.



## ■ Photocouplers

### ◆ Phototransistor Output

#### <Compact, SMT type>

○: Approved, △: Under application

(Ta = 25°C)

Output Type	Model No.	Internal connection diagram	Features	Approved by safety standards*2	Package	Absolute maximum ratings			Electro-optical characteristics						
				UL		Forward current I <sub>F</sub> (mA)	Isolation voltage (AC) Viso (rms) (kV)	Collector-emitter voltage V <sub>CEO</sub> (V)	Current transfer ratio			Response time			
									CTR (%) MIN.	I <sub>F</sub> (mA)	V <sub>CE</sub> (V)	t <sub>r</sub> (μs) TYP.	I <sub>C</sub> (mA)	R <sub>L</sub> (Ω)	V <sub>CE</sub> (V)
Single phototransistor output	PC357NJ0000F		General purpose	○*	Mini-flat 4-pin	50	3.75	80	50	5	5	4	2	100	2
	PC352NJ0000F		General purpose, high resistance to noise*1	○		50	3.75	80	90	5	5	4	2	100	2
	PC451J00000F		High collector-emitter voltage	○*		50	3.75	350	40	5	5	4	2	100	2
	PC367NJ00000F		Low input current, high CMR (MIN. 10kV/μs)	○		10	3.75	80	100	0.5	5	4	2	100	2
	PC354NJ00000F		AC input response	○*		±50	3.75	80	20	±1	5	4	2	100	2
	PC364NJ00000F		Low input current, high resistance to noise*1, AC input response	○		±10	3.75	70	50	±0.5	5	4	2	100	2
Darlington photo-transistor output	PC355NJ0000F		High sensitivity	○*	50	3.75	35	600	1	2	60	2	100	2	
	PC365NJ0000F		High sensitivity, low input current	○	10	3.75	35	600	0.5	2	60	2	100	2	

\*1 CMR: MIN.10 kV/μs

\*2 Please refer to Specification Sheets for model numbers approved by safety standards.

\* A VDE approved type is optionally available.

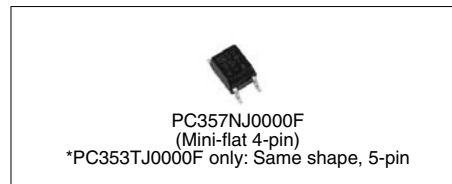

#### Notice

In the absence of confirmation by device specification sheets, SHARP takes no responsibility for any defects that may occur in equipment using any SHARP devices shown in catalogs, data books, etc. Except where specially indicated, models listed on this page comply with the RoHS Directive\*. For details, please contact SHARP. \*RoHS Directive: Prohibits use of lead, cadmium, hexavalent chromium, mercury and specific brominated flame retardants (PBBs and PBDEs), with certain exceptions. Contact SHARP in order to obtain the latest device specification sheets before using any SHARP device.

## ◆ Phototransistor Output <Compact, half pitch (lead space) SMT type>

○: Approved, △: Under application

(Ta = 25°C)

Type	Model No.	Internal connection diagram	Features	Approved by safety standards*3 UL	Package	Absolute maximum ratings			Electro-optical characteristics							
						Forward current I <sub>F</sub> (mA)	Isolation voltage (AC) V <sub>iso</sub> (rms) (kV)	Collector-emitter voltage V <sub>CEO</sub> (V)	Current transfer ratio			Response time				
									CTR (%) MIN.	I <sub>F</sub> (mA)	V <sub>CE</sub> (V)	t <sub>r</sub> (μs) TYP.	I <sub>C</sub> (mA)	R <sub>L</sub> (Ω)	V <sub>CE</sub> (V)	
Single phototransistor output	★PC3HU7NYIP0F		Reinforced insulation (internal insulation distance: MIN. 0.4 mm), low-profile package	○*4, 5	Low-profile mini-flat 4-pin	50	3.75	80	50	5	5	4	2	100	2	
	PC3H2J00000F		High resistance to noise*1	○	Mini-flat 4-pin	50	2.5	80	20	1	5	4	2	100	2	
	PC3H7J00000F		Standard	○*2		50	2.5	80	20	1	5	4	2	100	2	
	PC3H71xNIP0F		High resistance to noise*1, low input current	○		10	2.5	80	100	0.5	5	4	2	100	2	
	PC3H3J00000F	AC input response, high resistance to noise*1	○	±50		2.5	80	20	±1	5	4	2	100	2		
	PC3H4J00000F	AC input response	○*2	±50		2.5	80	20	±1	5	4	2	100	2		
	PC3H41xNIP0F	AC input response, high resistance to noise*1, low input current	○	±10		2.5	80	50	±0.5	5	4	2	100	2		
	PC4H510NIP0F	High collector-emitter voltage	○	50		2.5	350	40	5	5	4	2	100	2		
	PC3Q67QJ000F▲	4-ch type	○*2	50		2.5	80	50	5	5	4	2	100	2		
	PC3Q62J0000F▲	High resistance to noise*1, 4-ch type	○	50		2.5	80	20	1	5	4	2	100	2		
	PC3Q71xNIP0F▲	High resistance to noise*1, 4-ch type, low input current	○	10		2.5	80	100	0.5	5	4	2	100	2		
	Darlington photo-transistor output	PC3Q63J0000F▲		AC input response, high resistance to noise*1, 4-ch type		○	Mini-flat 16-pin	±50	2.5	80	20	±1	5	4	2	100
PC3Q64QJ000F▲		AC input response, 4-ch type		○*2		±50		2.5	80	20	±1	5	4	2	100	2
PC3Q41xNIP0F▲		AC input response, high resistance to noise*1, low input current, 4-ch type	○	±10	2.5	80		50	±0.5	5	4	2	100	2		
PC3H5J00000F		High sensitivity	○*2	50	2.5	35		600	1	2	60	2	100	2		
PC3H510NIP0F		High sensitivity, low input current	○	10	2.5	35		600	0.5	2	60	2	100	2		
PC4H520NIP0F▲		High collector-emitter voltage	○	50	2.5	350		1 000	1	2	100	2	100	2		
PC3Q65J0000F▲		4-ch type, high sensitivity	○*2	50	2.5	35		600	1	2	60	2	100	2		
PC3Q510NIP0F▲		4-ch type, high sensitivity, low input current	○	10	2.5	35		600	0.5	2	60	2	100	2		

\*1 CMR: MIN.10 kV/μs

\*2 A VDE approved type is optionally available.

\*3 Please refer to Specification Sheets for model numbers approved by safety standards.

\*4 VDE, CSA approved

\*5 In conformance with BSI, SEMKO, DEMKO, NEMKO, and FIMKO

The model marked with ▲ may not be available in the near future. Contact with SHARP for details before use.

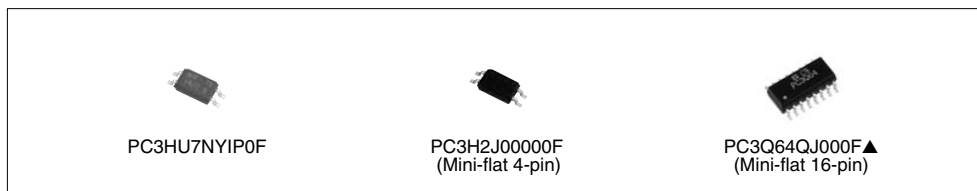

### Notice

In the absence of confirmation by device specification sheets, SHARP takes no responsibility for any defects that may occur in equipment using any SHARP devices shown in catalogs, data books, etc.

Except where specially indicated, models listed on this page comply with the RoHS Directive\*. For details, please contact SHARP. \*RoHS Directive: Prohibits use of lead, cadmium, hexavalent chromium, mercury and specific brominated flame retardants (PBBs and PBDEs), with certain exceptions.

Contact SHARP in order to obtain the latest device specification sheets before using any SHARP device.



## ◆ Phototransistor Output <DIP type (4/16-pin)>

○: Approved, △: Under application

(Ta = 25°C)

Output Type	Model No.	Internal connection diagram	Features	Approved by safety standards*8			Package	Absolute maximum ratings			Electro-optical characteristics				
				UL	VDE *2	Others *3		Forward current I <sub>F</sub> (mA)	Isolation voltage (AC) V <sub>iso</sub> (rms) (kV)	Collector-emitter voltage V <sub>CEO</sub> (V)	Current transfer ratio CTR (%) MIN.	I <sub>F</sub> (mA)	t <sub>r</sub> (μs) TYP.	R <sub>L</sub> (Ω)	
Single phototransistor output	PC123J0000F*1		High isolation voltage, long creepage distance	○	○	○	4-pin DIP	50	5.0	70	50	5	4	100	
	PC1231xNSZ0F		High isolation voltage, long creepage distance, low input current, high resistance to noise*4	○	○	-		10	5.0	70	50	0.5	4	100	
	PC817XJ0000F*5, *6, *7		High isolation voltage	○	○	-		50	5.0	80	50	5	4	100	
	PC847XJ0000F*5, *9		High isolation voltage (4-ch)	○	○	-	16-pin DIP	50	5.0	80	50	5	4	100	
	PC8171xNSZ0F		High isolation voltage, low input current, high resistance to noise*4	○	-	-	4-pin DIP	10	5.0	70	100	0.5	4	100	
	PC851XJ0000F		High isolation voltage, high collector-emitter voltage	○	-	-		50	5.0	350	40	5	4	100	
	PC814XJ0000F*5, *6		High isolation voltage, AC input response	○	○	-	4-pin DIP	±50	5.0	80	20	±1	4	100	
	PC844XJ0000F		High isolation voltage, AC input response (4-ch)	○	○	-		16-pin DIP	±50	5.0	80	20	±1	4	100
	PC8141xNSZ0F		High isolation voltage, AC input response, low input current, high resistance to noise*4	○	-	-		4-pin DIP	±10	5.0	80	50	±0.5	4	100
PC81100NSZ0F		Built-in schottky barrier diode, toff: 35μs TYP. (In saturation, R <sub>L</sub> = 100kΩ)	○	-	-	4-pin DIP	50	5.0	70	50	5	ton: TYP. 9	100		
Darlington phototransistor output	PC815XJ0000F		High isolation voltage, high sensitivity	○	-	-	4-pin DIP	50	5.0	35	600	1	60	100	
	PC845XJ0000F		High isolation voltage, high sensitivity (4-ch)	○	-	-	16-pin DIP	50	5.0	35	600	1	60	100	
	PC81510NSZ0F		High isolation voltage, high sensitivity, low input current	○	-	-	4-pin DIP	10	5.0	35	600	0.5	60	100	
	PC852XJ0000F*5, *6		High isolation voltage, high collector-emitter voltage	○	○	-		50	5.0	350	1 000	1	100	100	
	PC853XJ0000F*5, *6		High isolation voltage, high collector-emitter voltage	○	○	-		50	5.0	350	1 000	1	100	100	

\*1 Wide lead spacing type (F type) is also available. Creepage distance PC123: 6.4 mm or more, PC123F: 8 mm or more

\*2 Optionally available.

\*3 BSI, SEMKO, DEMKO, NEMKO, FIMKO, CSA

\*4 CMR: 10 kV/μs MIN.

\*5 Lead forming type (I type) is also available for surface mounting.

\*6 Taped package of lead forming type for surface mounting is also available.

\*7 Wide lead spacing type (F type) is also available. Lead forming type (FI type) of F type is also available. Taped package is also available for I and FI type of lead forming type.

\*8 Please refer to Specification Sheets for model numbers approved by safety standards.

\*9 Approved by UL as multi-channel type of PC817.



PC817XJ0000F  
(4-pin DIP)

PC847XJ0000F  
(16-pin DIP)

### Notice

In the absence of confirmation by device specification sheets, SHARP takes no responsibility for any defects that may occur in equipment using any SHARP devices shown in catalogs, data books, etc.

Except where specially indicated, models listed on this page comply with the RoHS Directive\*. For details, please contact SHARP. \*RoHS Directive: Prohibits use of lead, cadmium, hexavalent chromium, mercury and specific brominated flame retardants (PBBs and PBDEs), with certain exceptions.

Contact SHARP in order to obtain the latest device specification sheets before using any SHARP device.





## ◆ Phototransistor Output <DIP type (6-pin)>

○: Approved, △: Under application

(Ta = 25°C)

Output Type	Model No.	Internal connection diagram	Features	Approved by safety standards*2		Package	Absolute maximum ratings			Electro-optical characteristics			
				UL	VDE*1		Forward current I <sub>F</sub> (mA)	Isolation voltage (AC) V <sub>iso</sub> (rms) (kV)	Collector-emitter voltage V <sub>CEO</sub> (V)	Current transfer ratio		Response time	
										CTR (%) MIN.	I <sub>F</sub> (mA)	t <sub>r</sub> (μs) TYP.	R <sub>L</sub> (Ω)
Darlington phototransistor output (Single phototransistor output)	PC714V0NSZXF		High isolation voltage	○	○	6-pin DIP	50	5.0	80	50	5	4	100
	PC724V0NSZXF		High isolation voltage, large input current	○	—		150	5.0	35	20	100	4	100
	PC713V0NSZXF	High isolation voltage, with base terminal	○	○	50		5.0	80	50	5	4	100	
	PC715V0NSZXF	High isolation voltage, high sensitivity	○	○	50		5.0	35	600	1	60	100	
	PC725V0NSZXF	High isolation voltage, high sensitivity, high collector-emitter voltage, high power	○	○	50		5.0	300	1 000	1	100	100	

\*1 Optionally available.

\*2 Please refer to Specification Sheets for model numbers approved by safety standards.

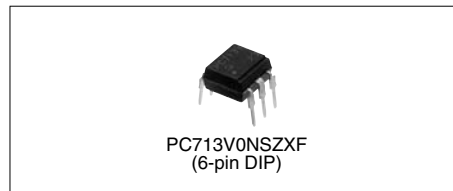

### Notice

In the absence of confirmation by device specification sheets, SHARP takes no responsibility for any defects that may occur in equipment using any SHARP devices shown in catalogs, data books, etc. Except where specially indicated, models listed on this page comply with the RoHS Directive\*. For details, please contact SHARP. \*RoHS Directive: Prohibits use of lead, cadmium, hexavalent chromium, mercury and specific brominated flame retardants (PBBs and PBDEs), with certain exceptions. Contact SHARP in order to obtain the latest device specification sheets before using any SHARP device.



## ◆OPIC\* Output <Compact, SMT type> (1-1)

\* "OPIC" (Optical IC) is a trademark of SHARP Corporation. An OPIC consists of a light-detecting element and a signal-processing circuit integrated onto a single chip.

○: Approved, △: Under application

(Ta = 25°C)

Model No.	Internal connection diagram	Features	Approved by safety standards*2		Package	Absolute maximum ratings		Electro-optical characteristics*1						
			UL	VDE*3		Forward current IF (mA)	Isolation voltage (AC) Viso (rms) (kV)	Low level output voltage			Threshold input current			
								VOL (V) MAX.	Ta (°C)	IOI (mA)	IF (mA)	IFHL (mA) MAX.	IFLH (mA) MAX.	RL (Ω)
PC400J00000F		Digital output, normal-off operation	○	-	Mini-flat 5-pin	50	3.75	0.4	0 to +70	16	4	2.0	-	280
PC401J00000F		Digital output, normal-on operation	○	-		50	3.75	0.4	0 to +70	16	0	-	2.0	280
PC456L0NIP0F		Built-in preamplifier, high speed transmission (2 Mb/s), For flow soldering	○	○		25	3.75	0.6	-40 to +85	4.4	10	5.0	-	20 k
PC410L0NIP0F		High speed (10 Mb/s), High CMR (10 kV/μs), For flow soldering	○	○		20	3.75	0.6	-40 to +85	13	5	5.0	-	350
PC410S0NIP0F		High speed (10 Mb/s), High CMR (10 kV/μs), For flow soldering, Solder heat resistance: 270°C	○	○	SOP 8-pin	20	3.75	0.6	-40 to +85	13	5	5.0	-	350
PC412S0NIP0F		High speed (25 Mb/s), High CMR (10 kV/μs), For flow soldering, Solder heat resistance: 270°C	○	-		-*4	3.75	1	-40 to +85	4	VIN = VIL	-	-	-
PC411L0NIP0F		High speed (15 Mb/s), High CMR (10 kV/μs), For flow soldering	○	○	Mini-flat 5-pin	20	3.75	0.1	-40 to +85	0.02	12	6.0	-	-
PC411S0NIP0F		High speed (15 Mb/s), High CMR (10 kV/μs), For flow soldering, Solder heat resistance: 270°C	○	○	SOP 8-pin	20	3.75	0.1	-40 to +85	0.02	12	6.0	-	-
PC4D10SNIP0F		High speed (10 Mb/s), For flow soldering, Solder heat resistance: 270°C 2ch output	○	-		20	3.75	0.6	-40 to +85	13	5	5.0	-	-

A: Rated voltage circuit

\*1 Each item is measured at Vcc=5V. (PC400, PC401)

\*2 Please refer to Specification Sheets for model numbers approved by safety standards.

\*3 Optionally available.

\*4 No forward current rating for voltage input (rated input voltage: -0.5 to 6.0 V).

### Notice

In the absence of confirmation by device specification sheets, SHARP takes no responsibility for any defects that may occur in equipment using any SHARP devices shown in catalogs, data books, etc.  
 Except where specially indicated, models listed on this page comply with the RoHS Directive\*. For details, please contact SHARP.  
 \*RoHS Directive: Prohibits use of lead, cadmium, hexavalent chromium, mercury and specific brominated flame retardants (PBBs and PBDEs), with certain exceptions.  
 Contact SHARP in order to obtain the latest device specification sheets before using any SHARP device.



## <Compact, SMT type> (1-2)

○: Approved, △: Under application

(Ta = 25°C)

Model No.	Internal connection diagram	Features	Approved by safety standards*1		Package	Absolute maximum ratings		Electro-optical characteristics							
			UL	VDE*2		Forward current I <sub>F</sub> (mA)	Isolation voltage (AC) Viso (rms) (kV)	Current transfer ratio				Propagation delay time			
								CTR (%) MIN.	I <sub>F</sub> (mA)	V <sub>O</sub> (V)	V <sub>CC</sub> (V)	t <sub>PHL</sub> (μs) TYP.	t <sub>PLH</sub> (μs) TYP.	R <sub>L</sub> (Ω)	I <sub>F</sub> (mA)
PC457L0NIP0F		High speed (1 Mb/s), high CMR (15 kV/μs), For flow soldering	○	○	Mini-flat 5-pin	25	3.75	19	16	0.4	4.5	0.2	0.6	1 900	16
PC457S0NIP0F		High speed (1 Mb/s), high CMR (15 kV/μs), For flow soldering, Solder heat resistance: 270°C	○	○	SOP 8-pin	25	3.75	19	16	0.4	4.5	0.2	0.6	1 900	16

\*1 Please refer to Specification Sheets for model numbers approved by safety standards.

\*2 Optionally available.



## ◆OPIC Output

### <DIP type, digital output>

○: Approved, △: Under application

(Ta = 25°C)

Model No.	Internal connection diagram	Features	Approved by safety standards*6		Package	Absolute maximum ratings		Electro-optical characteristics*1						
			UL	VDE*4		Forward current I <sub>F</sub> (mA)	Isolation voltage (AC) Viso (rms) (kV)	Low level output voltage			Threshold input current			
								V <sub>OL</sub> (V) MAX.	T <sub>a</sub> (°C)	I <sub>OL</sub> (mA)	I <sub>F</sub> (mA)	I <sub>FHL</sub> (mA) MAX.	I <sub>FLH</sub> (mA) MAX.	R <sub>L</sub> (Ω)
PC900V0NSZXF*2, *3		Digital output, normal-off operation	○	○	6-pin DIP	50	5.0	0.4	0 to +70	16	4	2.0	-	280
PC901V0NSZXF		Digital output, normal-on operation	○	○		50	5.0	0.4	0 to +70	16	0	-	2.0	280
PC956L0NSZ0F		Built-in preamplifier, high speed transmission (2 Mb/s) For soldering flow	○	○	8-pin DIP	25	5.0	0.6	-40 to +85	2.4	10	5.0	-	20 k
PC910L0NSZ0F		Digital output, High speed (10 Mb/s), high CMR (20 kV/μs) For soldering flow	○	○		20	5.0	0.6	-40 to +85	13	5	5.0	-	350
PC911L0NSZ0F		High speed (15 Mb/s), high CMR (10 kV/μs), For soldering flow	○	○		20	5.0	0.1	-40 to +85	0.02	12	6.0	-	-
PC912L0NSZ0F▲		Digital output, High speed (25 Mb/s), high CMR (20 kV/μs)	○	○		-*5	5.0	1.0	-40 to +85	4	V <sub>IN</sub> = V <sub>IL</sub>	-	-	-

A: Rated voltage circuit

\*1 Each item is measured at V<sub>CC</sub>=5V.

\*3 Taped package of lead forming type for surface mounting is also available.

\*5 No forward current rating due to voltage input. (rated input voltage: -0.5 to 6.0 V)

\*6 Please refer to Specification Sheets for model numbers approved by safety standards.

The model marked with ▲ may not be available in the near future. Contact with SHARP for details before use.

\*2 Lead forming type (I type) is also available for surface mounting.

\*4 Optionally available.

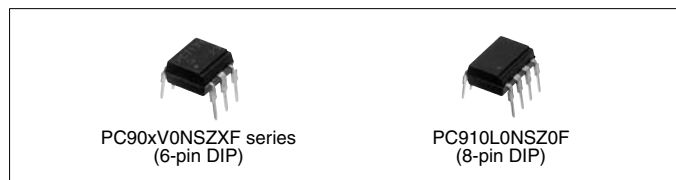

#### Notice

In the absence of confirmation by device specification sheets, SHARP takes no responsibility for any defects that may occur in equipment using any SHARP devices shown in catalogs, data books, etc.

Except where specially indicated, models listed on this page comply with the RoHS Directive\*. For details, please contact SHARP. \*RoHS Directive: Prohibits use of lead, cadmium, hexavalent chromium, mercury and specific brominated flame retardants (PBBs and PBDEs), with certain exceptions.

Contact SHARP in order to obtain the latest device specification sheets before using any SHARP device.



### ◆OPIC Output <DIP type, Gate drive type>

○: Approved, △: Under application

(Ta = 25°C)

Model No.	Internal connection diagram	Features	Approved by safety standards*3		Package	Absolute maximum ratings			Electro-optical characteristics					
			UL	VDE*2		Forward current I <sub>F</sub> (mA)	Isolation voltage (AC) Viso (rms) (kV)	Output current I <sub>O1</sub> (A)	Propagation delay time					
						t <sub>PHL</sub> (μs) TYP.	t <sub>PLH</sub> (μs) TYP.	V <sub>CC</sub> (V)	I <sub>F</sub> (mA)	R <sub>L1</sub> (Ω)	R <sub>L2</sub> (Ω)			
PC942J00000F		For controlling inverter-controlled air-conditioner	○	○	8-pin DIP	25	5.0	0.5	2.0	2.0	6	5	5	10
PC923L0NSZ0F*1		<ul style="list-style-type: none"> <li>Built-in drive circuit directly connectable to MOS-FET and IGBT</li> <li>Low dissipation current (I<sub>CC</sub> = TYP. 1.3 mA)</li> <li>High resistance to noise (CMR: MIN. 15 kV/μs)</li> </ul>	○	○		20	5.0	0.1	0.3	0.3	24	5	R <sub>G</sub> = 47	-
PC924L0NSZ0F*1		<ul style="list-style-type: none"> <li>Built-in drive circuit directly connectable to MOS-FET and IGBT</li> <li>Low dissipation current (I<sub>CC</sub> = TYP. 1.3 mA)</li> <li>High resistance to noise (CMR: MIN. 15 kV/μs)</li> </ul>	○	○		25	5.0	0.1	1.0	1.0	24	10	R <sub>G</sub> = 47	-
PC925L0NSZ0F		<ul style="list-style-type: none"> <li>Built-in drive circuit directly connectable to MOS-FET and IGBT</li> <li>Peak output current: 2.5 A</li> <li>Low dissipation current (I<sub>CC</sub> = TYP. 5 mA)</li> <li>High resistance to noise (CMR: MIN. 15 kV/μs)</li> </ul>	-	-		-	5.0	2.5	MAX. 0.5	MAX. 0.5	24	10	R <sub>G</sub> = 10	-
PC928J00000F▲		For driving inverter IGBT, built-in short protection circuit	○	○	14-pin SMT (Half pitch lead)	25	4.0	0.1	1.0	1.0	24	10	R <sub>G</sub> = 47	-
PC929J00000F▲		For driving inverter IGBT, high speed, built-in short protection circuit	○	○		20	4.0	0.1	0.3	0.3	24	5	R <sub>G</sub> = 47	-

\*1 Lead forming type (I type) is also available for surface mounting. Taped package of lead forming type for surface mounting is also available.

\*2 A VDE approved type is optionally available.

\*3 Please refer to Specification Sheets for model numbers approved by safety standards.

The model marked with ▲ may not be available in the near future. Contact with SHARP for details before use.

### ◆OPIC Output <DIP type, analog/digital output>

○: Approved, △: Under application

(Ta = 25°C)

Model No.	Internal connection diagram	Features	Approved by safety standards*3		Package	Absolute maximum ratings			Electro-optical characteristics						
			UL	VDE*2		Forward current I <sub>F</sub> (mA)	Isolation voltage (AC) Viso (rms) (kV)	Current transfer ratio			Propagation delay time*1				
						CTR (%) MIN	I <sub>F</sub> (mA)	V <sub>O</sub> (V)	V <sub>CC</sub> (V)	t <sub>PHL</sub> (μs) TYP.	t <sub>PLH</sub> (μs) TYP.	R <sub>L</sub> (Ω)	I <sub>F</sub> (mA)		
PC957L0NSZ0F		High speed (1 Mb/s), high CMR (15 kV/μs), for flow soldering	○	○	8-pin DIP	25	5.0	19	16	0.4	4.5	0.2	0.6	1 900	16

\*1 V<sub>CC</sub> = 5V

\*2 Optionally available.

\*3 Please refer to Specification Sheets for title(s) of safety standards.

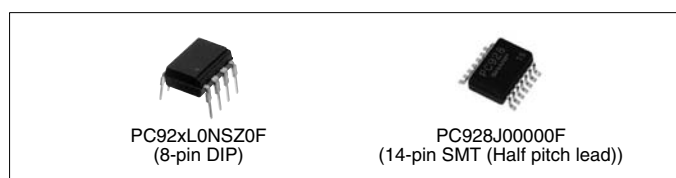

PC92xL0NSZ0F  
(8-pin DIP)

PC928J00000F  
(14-pin SMT (Half pitch lead))

#### Notice



In the absence of confirmation by device specification sheets, SHARP takes no responsibility for any defects that may occur in equipment using any SHARP devices shown in catalogs, data books, etc.

Except where specially indicated, models listed on this page comply with the RoHS Directive\*. For details, please contact SHARP. \*RoHS Directive: Prohibits use of lead, cadmium, hexavalent chromium, mercury and specific brominated flame retardants (PBBs and PBDEs), with certain exceptions.

Contact SHARP in order to obtain the latest device specification sheets before using any SHARP device.

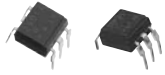

## ■ Phototriac Coupler Lineup

Package	Applied voltage	ON-state current (rms)	Features	Model No.	Page
Mini-flat (SMD) 	AC 200 V lines (V <sub>DRM</sub> = 600V)	0.05 A	General purpose	S2S3000F* <sup>4</sup> / S2S5A00F* <sup>4</sup>	76
			Built-in zero-cross circuit	S2S4000F* <sup>4</sup>	76
			Reinforced isolation	PC3SG11YIZ0F▲* <sup>4</sup>	76
			Built-in zero-cross circuit	PC3SG21YIZ0F▲* <sup>4</sup>	76
DIP type (4-pin) 	AC 200 V lines (V <sub>DRM</sub> = 600V)	0.1 A	General purpose	PC3ST11NSZAF	76
			Built-in zero-cross circuit	PC3ST21NSZBF* <sup>3</sup>	77
			Reinforced isolation	PC3SH11YFZAF* <sup>4</sup> / PC3SH13YFZAF* <sup>4</sup>	76
			Built-in zero-cross circuit	PC3SH21YFZBF* <sup>3</sup>	77
DIP type (6-pin) 	AC 100 V lines (V <sub>DRM</sub> = 400V)	0.1 A	General purpose (5th-pin cut)	PC2SD11NTZAF* <sup>4</sup>	76
	AC 200 V lines (V <sub>DRM</sub> = 600V)	0.1 A	General purpose (5th-pin cut)	PC3SD12NTZAF* <sup>4</sup> / PC3SD11NTZAF▲* <sup>4</sup> / PC3SD11NTZBF* <sup>3</sup> / PC3SD11NTZCF* <sup>2</sup> / PC3SD11YTZDF* <sup>1</sup> / PC3SD21YTZEF* <sup>5</sup>	76/77
			Built-in zero-cross circuit	PC3SD21NTZBF* <sup>3</sup> / PC3SD21NTZCF* <sup>2</sup> / PC3SD21NTZDF* <sup>1</sup> / PC3SD23YTZCF* <sup>2</sup>	77
			Reinforced isolation (5th-pin cut)	PC3SF11YVZAF* <sup>4</sup> / PC3SF11YVZBF* <sup>3</sup>	76
			Built-in zero-cross circuit	PC3SF21YVZAF* <sup>4</sup> / PC3SF21YVZBF* <sup>3</sup> / PC3SF23YVZSF* <sup>3</sup>	77
			General purpose	PC4SD11NTZBF* <sup>3</sup> / PC4SD11NTZCF* <sup>2</sup>	76
			Built-in zero-cross circuit	PC4SD21NTZCF* <sup>2</sup> / PC4SD21NTZDF* <sup>1</sup>	77
			Reinforced isolation	PC4SF11YVZAF* <sup>4</sup> / PC4SF11YVZBF* <sup>3</sup>	76
			Built-in zero-cross circuit	PC4SF21YVZBF* <sup>3</sup> / PC4SF21YVZCF* <sup>2</sup>	77

Minimum trigger current: \*1 I<sub>FT</sub> ≤ 3 mA, \*2 I<sub>FT</sub> ≤ 5 mA, \*3 I<sub>FT</sub> ≤ 7 mA, \*4 I<sub>FT</sub> ≤ 10 mA, \*5 I<sub>FT</sub> ≤ 2 mA  
 The model marked with ▲ may not be available in the near future. Contact with SHARP for details before use.



## Phototriac Couplers

○: Approved, △: Under application

(Ta = 25°C)

Type	Model No.	Internal connection diagram	Features	Approved by safety standards*4			Package	Absolute maximum ratings			Electro-optical characteristics			
				UL	VDE	Others*5		ON-state current I <sub>T</sub> (rms) (A)	Repetitive peak OFF-state voltage V <sub>DRM</sub> (V)	Isolation voltage (AC) V <sub>iso</sub> (rms) (kV)	Min. trigger current I <sub>FT</sub> (mA) MAX.	V <sub>D</sub> (V)	R <sub>L</sub> (Ω)	
For triggering	S2S3000F		200 V lines, compact	○	○*6	○	Mini-flat 4-pin	0.05	600	3.75	10	6	100	
	S2S5A00F		200 V lines, compact	○	○*6	○					10	6	100	
	PC3SG11YZ0F▲		200 V lines, reinforced insulation (isolation thickness: 0.4 mm)	○	○	—					10	6	100	
	PC3ST11NSZAF		200 V lines, compact	○	○*6	○	4-pin DIP	0.1	600	5.0	10	6	100	
	PC3SH11YFZAF		200 V lines, compact, reinforced isolation	○	○	○*2					10	6	100	
	PC3SH13YFZAF		200 V lines, compact, reinforced isolation, High noise resistance	○	○	○*2					10	6	100	
	PC2SD11NTZAF*7		100 V lines	○	—	○	6-pin DIP*1,3	0.1	400	5.0	10	6	100	
	PC3SD12NTZAF*8		200 V lines	○	○*6	○					600	10	6	100
	PC3SD11NTZAF		200 V lines	○	○*6	○						10	6	100
	PC3SD11NTZBF		200 V lines	○	○*6	○					800	7	6	100
	PC4SD11NTZBF		200 V lines, repetitive peak-OFF-state voltage	○	○*6	○						7	6	100
	PC3SD11NTZCF		200 V lines	○	○*6	○					600	5	6	100
	PC3SD11YTZDF		200 V lines, low input drive	○	○	○						3	6	100
	PC4SD11NTZCF		200 V lines, repetitive peak-OFF-state voltage	○	○*6	○					800	5	6	100
	PC3SF11YVZAF		200 V lines, reinforced isolation	○	○	○*2						600	10	6
	PC3SF11YVZBF		200 V lines, reinforced isolation	○	○	○*2					7		6	100
	PC4SF11YVZAF		200 V lines, reinforced isolation, repetitive peak-OFF-state voltage	○	○	○*2					800	10	6	100
	PC4SF11YVZBF		200 V lines, reinforced isolation, repetitive peak-OFF-state voltage	○	○	○*2						7	6	100

For the note \*1 to \*9, see next page.

The model marked with ▲ may not be available in the near future. Contact with SHARP for details before use.

### Notice

In the absence of confirmation by device specification sheets, SHARP takes no responsibility for any defects that may occur in equipment using any SHARP devices shown in catalogs, data books, etc. Except where specially indicated, models listed on this page comply with the RoHS Directive\*. For details, please contact SHARP. \*RoHS Directive: Prohibits use of lead, cadmium, hexavalent chromium, mercury and specific brominated flame retardants (PBBs and PBDEs), with certain exceptions. Contact SHARP in order to obtain the latest device specification sheets before using any SHARP device.

# PHOTOTRIAC COUPLERS



## Phototriac Couplers (cont'd)

○: Approved, △: Under application

(Ta = 25°C)

Type	Model No.	Internal connection diagram	Features	Approved by safety standards*4			Package	Absolute maximum ratings			Electro-optical characteristics		
				UL	VDE	Others*5		ON-state current I <sub>T</sub> (rms) (A)	Repetitive peak OFF-state V <sub>DRM</sub> (V)	Isolation voltage (AC) V <sub>iso</sub> (rms) (kV)	Min. trigger current I <sub>FT</sub> (mA) MAX.	V <sub>D</sub> (V)	R <sub>L</sub> (Ω)
For triggering	S2S4000F		200 V lines, compact, built-in zero-cross circuit	○	○*6	○	Mini-flat 4-pin	0.05	600	3.75	10	6	100
	PC3SG21YZ0F▲		200 V lines, reinforced insulation (isolation thickness: 0.4 mm), built-in zero-cross circuit	○	○	—		0.05	600	3.75	10	6	100
	PC3ST21NSZBF		200 V lines, compact, built-in zero-cross circuit	○	○*6	○	4-pin DIP	0.1	600	5.0	7	4	100
	PC3SH21YFZBF		200 V lines, compact, reinforced isolation, built-in zero-cross circuit	○	○	○*2		0.1	600	5.0	7	4	100
	PC3SD21NTZBF		200 V lines, low zero-cross voltage: MAX. 20 V, built-in zero-cross circuit	○	○*6	○	6-pin DIP*1,3	0.1	600	5.0	7	4	100
	PC3SD21NTZCF*9		200 V lines, low zero-cross voltage: MAX. 20 V, built-in zero-cross circuit	○	○*6	○		0.1	600	5.0	5	4	100
	PC3SD23YTZCF		200 V lines, built-in zero-cross circuit, High pulse/noise resistance (TYP. 2 kV)	○	○	○		0.1	600	5.0	5	4	100
	PC3SD21NTZDF		200 V lines, low zero-cross voltage: MAX. 20 V, built-in zero-cross circuit	○	○*6	○		0.1	600	5.0	3	4	100
	PC3SD21YTZEF		200 V lines, built-in zero-cross circuit, Low input drive	○	○	○		0.1	600	5.0	2	4	100
	PC4SD21NTZCF		200 V lines, built-in zero-cross circuit, repetitive peak-OFF-state voltage	○	○*6	○		0.1	800	5.0	5	4	100
	PC4SD21NTZDF		200 V lines, built-in zero-cross circuit, repetitive peak-OFF-state voltage	○	○*6	○		0.1	800	5.0	3	4	100
	PC3SF21YVZAF		200 V lines, reinforced isolation built-in zero-cross circuit	○	○	○*2		0.1	600	5.0	10	4	100
	PC3SF21YVZBF		200 V lines, reinforced isolation built-in zero-cross circuit	○	○	○*2		0.1	600	5.0	7	4	100
	PC3SF23YVZSF		200 V lines, reinforced isolation, built-in zero-cross circuit, High pulse/noise resistance (TYP. 2 kV)	○	○	○*2		0.1	600	5.0	7	4	100
	PC4SF21YVZBF		200 V lines, reinforced isolation, built-in zero-cross circuit, repetitive peak-OFF-state voltage	○	○	○*2		0.1	800	5.0	7	4	100
	PC4SF21YVZCF		200 V lines, reinforced isolation, built-in zero-cross circuit, repetitive peak-OFF-state voltage	○	○	○*2		0.1	800	5.0	5	4	100

\*1 Lead forming type for surface mounting is also available.

\*2 In conformance with BSI, SEMKO, DEMKO, NEMKO, and FIMKO

\*3 These are molded pin No. 5.

\*4 Please refer to Specification Sheets for model numbers approved by safety standards.

\*5 CSA approval

\*6 Optionally available

\*7 An equivalent model (I<sub>FT</sub> MAX.: 15 mA) with overseas brand compatibility is also available. (PC1S3021NTZF)

\*8 An equivalent model with overseas brand compatibility is also available. (PC1S3052NTZF)

\*9 An equivalent model with overseas brand compatibility is also available. (PC1S3063NTZF)

The model marked with ▲ may not be available in the near future. Contact with SHARP for details before use.

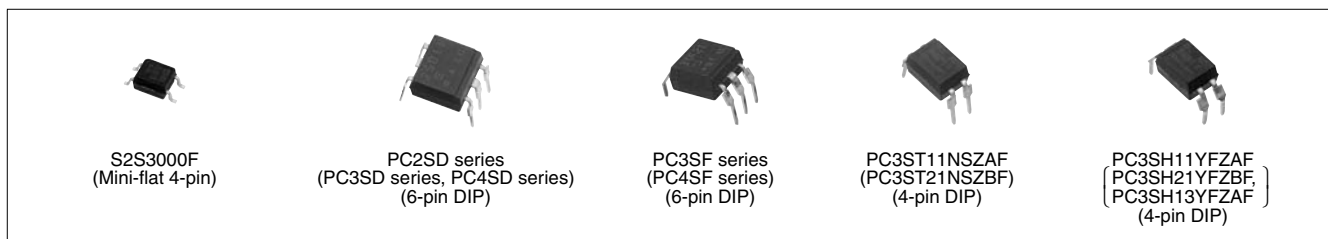

### Notice





In the absence of confirmation by device specification sheets, SHARP takes no responsibility for any defects that may occur in equipment using any SHARP devices shown in catalogs, data books, etc.

Except where specially indicated, models listed on this page comply with the RoHS Directive\*. For details, please contact SHARP. \*RoHS Directive: Prohibits use of lead, cadmium, hexavalent chromium, mercury and specific brominated flame retardants (PBBs and PBDEs), with certain exceptions.

Contact SHARP in order to obtain the latest device specification sheets before using any SHARP device.



## ■ Solid State Relay Lineup

Package	Applied voltage	Features	Model No.	Page
 DIP 6-pin	AC 100 V lines	General purpose	PR22MA11NTZF	79
	AC 200 V lines	General purpose	PR31MA11NTZF / PR32MA11NTZF	79
 DIP 8-pin	AC 100 V lines	General purpose	PR23MF11NSZF / PR26MF series / PR29MF series	79
		Built-in zero-cross circuit	PR26MF21NSZF / PR29MF21NSZF	79
	AC 200 V lines	General purpose	PR33MF51NSZF / PR36MF series / PR39MF series / PR3BMF11NSZF▲	79
		Built-in zero-cross circuit	PR36MF series / PR39MF series / PR3BMF21NSZF	79
  Sx0xT0xF series SIP 4-pin	AC 100 V lines	General purpose	S102T01F▲ / S108T01F▲ / S101S05F▲ / S102S01F▲ / S112S01F▲ / S116S01F▲	80
		Built-in zero-cross circuit	S102T02F▲ / S108T02F▲ / S101S06F▲ / S102S02F▲ / S116S02F▲	80
		Built-in snubber circuit	S102S11F▲	80
		Built-in zero-cross/snubber circuit	S101S16F▲ / S102S12F▲	80
	AC 200 V lines	General purpose	S202T01F▲ / S208T01F▲ / S202S01F▲ / S212S01F▲ / S216S01F▲	80
		Built-in zero-cross circuit	S202T02F▲ / S208T02F▲ / S201S06F▲ / S202S02F▲ / S216S02F▲	80/81
		Built-in snubber circuit	S202S15F▲ / S202S11F▲	80/81
		Built-in zero-cross/snubber circuit	S202S12F▲	81
		Reinforced isolation	S202SE1F▲ / S216SE1F▲	81
		Built-in zero-cross circuit	S202SE2F▲ / S216SE2F▲	81

The model marked with ▲ may not be available in the near future. Contact with SHARP for details before use.





## Solid State Relays

<DIP type>

○: Approved, △: Under application

(Ta = 25°C)

Model No.	Internal connection diagram	Features	Approved by safety standards*1			Package	Absolute maximum ratings			Electrical characteristics			
			UL	CSA	VDE*2		ON-state current I <sub>T</sub> (rms) (A)	Repetitive peak OFF-state voltage V <sub>DRM</sub> (V)	Isolation voltage (AC) V <sub>iso</sub> (rms) (kV)	Min. trigger current I <sub>FT</sub> (mA) MAX.	V <sub>D</sub> (V)	R <sub>L</sub> (Ω)	
PR31MA11NTZF		200 V lines, compact	○	○	○	6-pin DIP	0.06	600	5.0	10	6	100	
PR22MA11NTZF		100 V lines, 150 mA output in a small package	○	○	○								
PR32MA11NTZF		200 V lines, 150 mA output in a small package	○	○	○								
PR23MF11NSZF		100 V lines, compact	○	○	-	8-pin DIP	0.3	400	4.0	10	6	100	
PR33MF51NSZF		200 V lines, compact	○	○	○		0.3	600	4.0	10	6	100	
PR26MF11NSZF		100 V lines, compact	○	○	-		0.6	400	4.0	10	6	100	
PR26MF12NSZF		100 V lines, compact, low input current	○	○	-		0.6	400	4.0	5	6	100	
PR29MF11NSZF		100 V lines, compact	○	○	-		0.9	400	4.0	10	6	100	
PR29MF12NSZF		100 V lines, compact, low input current	○	○	-		0.9	400	4.0	5	6	100	
PR26MF21NSZF		100 V lines, compact (built-in zero-cross circuit)	○	○	-		0.6	400	4.0	10	6	100	
PR29MF21NSZF		100 V lines, compact (built-in zero-cross circuit)	○	○	-		0.9	400	4.0	10	6	100	
PR36MF51NSZF			200 V lines, compact	○	○		○	0.6	600	4.0	10	6	100
PR36MF12NSZF			200 V lines, compact, low input current	○	○		○	0.6	600	4.0	5	6	100
PR39MF11NSZF▲	200 V lines, compact		○	○	○	0.9	600	4.0	10	6	100		
PR39MF12NSZF	200 V lines, compact, low input current		○	○	○	0.9	600	4.0	5	6	100		
PR39MF51NSZF	200 V lines, compact		○	○	○	0.9	800	4.0	10	6	100		
PR3BMF11NSZF▲	200 V lines, compact, High-temperature operation		○	○	○	1.2	600	4.0	10	6	100		
PR36MF22NSZF		200 V lines, compact (built-in zero-cross circuit), low input current	○	○	○	8-pin DIP	0.6	600	4.0	5	6	100	
PR39MF22NSZF		200 V lines, compact (built-in zero-cross circuit), low input current	○	○	○		0.9	600	4.0	5	6	100	
PR36MF21NSZF		200 V lines, compact (built-in zero-cross circuit)	○	○	○		0.6	600	4.0	10	6	100	
PR39MF21NSZF		200 V lines, compact (built-in zero-cross circuit)	○	○	○		0.9	600	4.0	10	6	100	
PR3BMF21NSZF		200 V lines, compact (built-in zero-cross circuit)	○	○	○		1.2	600	4.0	10	6	100	

\*1 Please refer to Specification Sheets for model numbers approved by safety standards.

\*2 Optionally available.

The model marked with ▲ may not be available in the near future. Contact with SHARP for details before use.

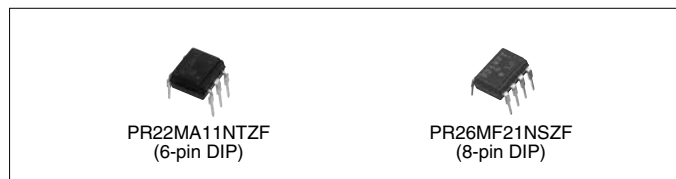

PR22MA11NTZF  
(6-pin DIP)

PR26MF21NSZF  
(8-pin DIP)

### Notice

In the absence of confirmation by device specification sheets, SHARP takes no responsibility for any defects that may occur in equipment using any SHARP devices shown in catalogs, data books, etc. Except where specially indicated, models listed on this page comply with the RoHS Directive\*. For details, please contact SHARP. \*RoHS Directive: Prohibits use of lead, cadmium, hexavalent chromium, mercury and specific brominated flame retardants (PBBs and PBDEs), with certain exceptions. Contact SHARP in order to obtain the latest device specification sheets before using any SHARP device.



### <SIP type> (1)

○: Approved, △: Under application

(Ta = 25°C)

Model No.	Internal connection diagram	Features	Approved by safety standards*6			Package	Absolute maximum ratings			Electrical characteristics										
			UL	CSA	TÜV EN 60950		ON-state current I <sub>T</sub> (rms) (A)	Repetitive peak OFF-state voltage V <sub>DRM</sub> (V)	Isolation voltage (AC) V <sub>iso</sub> (rms) (kV)	I <sub>FT</sub> (mA) MAX.	V <sub>D</sub> (V)	R <sub>L</sub> (Ω)								
S102T01F▲		100 V lines, low profile	○	○	-	Low profile 4-pin SIP	2	400	3.0	8	12	30								
S108T01F▲		100 V lines, low profile	-	-	-		8 <sup>*2</sup>						8	12	30					
S101S05F▲		100 V lines	○	○	-	4-pin SIP	3 <sup>*3</sup>	400	3.0	15	12	30								
S102S01F▲		100 V lines	○	○	-		8 <sup>*2</sup>						8	12	30					
S112S01F▲		100 V lines	○	○	-		12 <sup>*4</sup>		8	12	30									
S116S01F▲		100 V lines	○	○	-		16 <sup>*5</sup>		8	12	30									
S102T02F▲		100 V lines, low profile (built-in zero-cross circuit)	○	○	-	Low profile 4-pin SIP	2	400	3.0	8	12	30								
S108T02F▲		100 V lines, low profile (built-in zero-cross circuit)	-	-	-		8 <sup>*2</sup>						8	12	30					
S101S06F▲		100 V lines (built-in zero-cross circuit)	○	○	-	4-pin SIP	3 <sup>*3</sup>	400	3.0	15	6	30								
S102S02F▲		100 V lines (built-in zero-cross circuit)	○	○	-		8 <sup>*2</sup>						8	6	30					
S116S02F▲		100 V lines (built-in zero-cross circuit)	○	○	-		16 <sup>*5</sup>		8	6	30									
S102S11F▲		100 V lines (built-in snubber circuit)	○	○	-	4-pin SIP	8 <sup>*1</sup>	400	4.0	8	12	30								
S101S16F▲		100 V lines (built-in snubber circuit, built-in zero-cross circuit)	○	○	-		3 <sup>*3</sup>						400	3.0	15	6	30			
S102S12F▲		100 V lines (built-in snubber circuit, built-in zero-cross circuit)	○	○	-		8 <sup>*1</sup>											8	6	30
S202T01F▲		200 V lines, low profile	○	○	-	Low profile 4-pin SIP	2	600	3.0	8	12	30								
S208T01F▲		200 V lines, low profile	-	-	-		8 <sup>*2</sup>						8	12	30					
S202S01F▲		200 V lines	○	○	-	4-pin SIP	8 <sup>*2</sup>	600	4.0	8	12	30								
S212S01F▲		200 V lines	-	-	-		12 <sup>*4</sup>						8	12	30					
S216S01F▲		200 V lines	-	-	-		16 <sup>*5</sup>						8	12	30					
S202S15F▲		200 V lines, built-in snubber circuit	-	-	-	4-pin SIP	8 <sup>*6</sup>	600	3.0	10	12	30								
S202T02F▲		200 V lines, low profile (built-in zero-cross circuit)	○	○	-		2						3.0	8	12	30				
S208T02F▲		200 V lines, low profile (built-in zero-cross circuit)	-	-	-		8 <sup>*2</sup>										8	12	30	
S201S06F▲		200 V lines (built-in zero-cross circuit)	○	○	-		3 <sup>*3</sup>						600	4.0	15	6	30			
S202S02F▲		200 V lines (built-in zero-cross circuit)	○	○	-		8 <sup>*2</sup>											8	6	30
S216S02F▲		200 V lines (built-in zero-cross circuit)	-	-	-		16 <sup>*5</sup>											8	6	30

\*1 to \*6: Please refer to the next page.

The model marked with ▲ may not be available in the near future. Contact with SHARP for details before use.

#### Notice

In the absence of confirmation by device specification sheets, SHARP takes no responsibility for any defects that may occur in equipment using any SHARP devices shown in catalogs, data books, etc. Except where specially indicated, models listed on this page comply with the RoHS Directive\*. For details, please contact SHARP. \*RoHS Directive: Prohibits use of lead, cadmium, hexavalent chromium, mercury and specific brominated flame retardants (PBBs and PBDEs), with certain exceptions. Contact SHARP in order to obtain the latest device specification sheets before using any SHARP device.

# SOLID STATE RELAYS



## <SIP type> (2)

○: Approved, △: Under application

(Ta = 25°C)

Model No.	Internal connection diagram	Features	Approved by safety standards*6			Package	Absolute maximum ratings			Electrical characteristics		
			UL	CSA	TÜV EN 60950		ON-state current I <sub>T</sub> (rms) (A)	Repetitive peak OFF-state voltage V <sub>DRM</sub> (V)	Isolation voltage (AC) V <sub>iso</sub> (rms) (kV)	I <sub>FT</sub> (mA) MAX.	V <sub>D</sub> (V)	R <sub>L</sub> (Ω)
S202S11F▲		200 V lines (built-in snubber circuit)	○	○	-	4-pin SIP	8*1	600	4.0	8	12	30
S202S12F▲		200 V lines (built-in snubber circuit, built-in zero-cross circuit)	○	○	-		8*1	600	4.0	8	6	30
S202SE1F▲		200 V lines, reinforced isolation	○	○	○		8*2	600	3.0	8	12	30
S216SE1F▲			-	-	○		16*5			8	12	30
S202SE2F▲		200 V lines (built-in zero-cross circuit), reinforced isolation	○	○	○		8*2	600	3.0	8	6	30
S216SE2F▲			-	-	○		16*5			8	6	30

\*1 T<sub>c</sub> ≤ 88°C

\*2 T<sub>c</sub> ≤ 80°C

\*3 T<sub>c</sub> ≤ 100°C

\*4 T<sub>c</sub> ≤ 70°C

\*5 T<sub>c</sub> ≤ 60°C

\*6 Please refer to Specification Sheets for model numbers approved by safety standards.

The model marked with ▲ may not be available in the near future. Contact with SHARP for details before use.



### Notice

In the absence of confirmation by device specification sheets, SHARP takes no responsibility for any defects that may occur in equipment using any SHARP devices shown in catalogs, data books, etc. Except where specially indicated, models listed on this page comply with the RoHS Directive\*. For details, please contact SHARP. \*RoHS Directive: Prohibits use of lead, cadmium, hexavalent chromium, mercury and specific brominated flame retardants (PBBs and PBDEs), with certain exceptions. Contact SHARP in order to obtain the latest device specification sheets before using any SHARP device.



## ■ Photointerrupter Lineup

### <Transmissive type>

Output type	Package type	Outline	Mounting method	Model No. (series)	Page	
Single phototransistor	Compact	General purpose	PWB mounting type	GP1S2x series/GP1S37J0000F	83	
High response speed	Case type	High resolution	PWB mounting type/ Soldering reflow	GP1S2xJ0000F series/GP1S092HCPIF/ GP1S9xJ0000F series/ GP1S09xHCZ0F series/ GP1S19xHCZ0F/GP1S19xHCxSF	83	
				Two-phase PT output	PWB mounting type	GP1S39J0000F
		General purpose	Snap-in	GP1S566VJ00F	84	
	With connector	Case type	High resolution	PWB mounting type, etc.	GP1S5x series/GP1S5xVJ000F series/ GP1S56x series	84
			Horizontal slit, High resolution	PWB mounting type	GP1S59J0000F/GP1S525VJ00F	84
		General purpose	Snap-in	GP1S74PJ000F	84	
Darlington phototransistor	Case type	General purpose	PWB mounting type, etc.	GP1L5xJ series/GP1L5xV series	85	
High sensitivity		Wide gap	PWB mounting type	GP1L57J0000F	85	
Digital output	Compact	Low voltage operation	PWB mounting type	GP1A91 series/GP1A98HCZ0F	85	
(OPIC output)	Case type	High resolution	PWB mounting type	GP1A5x series	86	
		Wide gap	Both-side/PWB mounting type	GP1A5xHR series/GP1A52LRJ00F	86	
	With connector	General purpose	Screw mounting type/Snap-in	GP1A05 series/GP1A7x series/ GP1A07x series	87	

### <Reflective type>

Output type	Package type	Outline	Mounting method	Model No. (series)	Page
Single phototransistor	Compact, DIP	General purpose	PWB mounting type	GP2S2x series	87
High response speed	Leadless	Long focal distance	PWB mounting type	GP2S40J0000F	87
		Long focal distance	PWB mounting type	GP2S700HCP	87
	Compact, thin (leadless)	General purpose	PWB mounting type	GP2S60	87
Darlington phototransistor	Compact, DIP	General purpose	PWB mounting type	GP2L24J0000F	88
High sensitivity			Screw mounting type/ Compact snap-in/ Inverter light countermeasures	GP2A2x series, GP2A200LCS0F/ GP2A231LRSAF, GP2A240LCS0F	88
OPIC output	With connector	Light modulation type, Sensitivity adjusted			

### <Application-specific photointerrupter lineup>

Detection type	Outline (Output type etc.)	Mounting method	Model No. (series)	Page	
Transmissive type	With connector With actuator (Phototransistor output)	Snap-in	GP1S44S1J00F	89	
	With connector With actuator (OPIC output)	Snap-in	GP1A44E1J00F	89	
	Compact, [built-in ball]	(2-phase PT output) 3 direction detection	PWB mounting type	GP1S36J0000F	90
		(2-phase PT output) 4 direction detection	PWB mounting type	GP1S036HEZ	90
	Case type With encoder function	Resolution: Linear scale slit pitch: 0.7 mm	Side mounting type	GP1A3xR series	90
	Phase A (digital output) Phase B (digital output)	Resolution: Linear scale slit pitch: 0.17/0.14 mm	PWB mounting type	GP1A038RBK0F/GP1A046RBZLF/ GP1A047RBZLF/GP1A038RCK0F/ GP1A044RCKLF	90
		Resolution: Linear scale slit pitch: 0.085	PWB mounting type	GP1A037RDKJF/GP1A047RDZLF	90
Reflective type	Injection For prism system (Single phototransistor)	Screw mounting	GP2S29SJ000F	91	
	For amusement industry	-	GP2A221HRKA/GP2A222HCKA	91	



## ■ Photointerrupters

### <Transmissive type>

#### ◆ Single phototransistor output

### <Compact type>

(Ta = 25°C)

Model No.	Internal connection diagram	Features	Detecting and emitting gap (mm)	Slit width (mm)	Electro-optical characteristics						
					Current transfer ratio			Response time			
					CTR (%) MIN.	IF (mA)	VCE (V)	tr (μs) TYP.	Ic (mA)	RL (Ω)	VCE (V)
GP1S25J0000F▲		Side lead type, For soldering reflow	1.6	0.3	1.0	5	5	35	0.1	1 000	5
GP1S27J0000F▲		PWB mounting type	0.9	0.8	4.3	1.5	5	50	0.1	1 000	5
GP1S092HCPIF		Height: 2.9 mm, For soldering reflow, with positioning boss	2.0	0.3	2.0	5	5	50	0.1	1 000	5
GP1S37J0000F▲		PWB mounting type	2.0	0.8	1	3	5	50	0.1	1 000	5
GP1S93J0000F▲		Wide gap, low profile (3.1 mm)	2.0	0.3	2.0	5	5	50	0.1	1 000	5
GP1S093HCZ0F		Wide gap, low profile (2.9 mm)	2.0	0.3	2.0	5	5	50	0.1	1 000	5
GP1S94J0000F▲		Wide gap, with positioning pin	3.5	0.3	0.8	5	5	50	0.1	1 000	5
GP1S094HCZ0F		Wide gap, with positioning pin, PWB mounting type (5.5 × 2.6 × 4.8 mm)	3.0	0.3	0.8	5	5	50	0.1	1 000	5
GP1S95J0000F▲		High resolution, thin detector type	1.6	0.3	1.0	5	5	35	0.1	1 000	5
GP1S96J0000F▲		Low profile (3.5 × 2.6 × 3.1 mm)	1.0	0.3	2.0	5	5	50	0.1	1 000	5
GP1S096HCZ0F		Low profile (3.5 × 2.6 × 2.9 mm)	1.0	0.3	2.0	5	5	50	0.1	1 000	5
GP1S194HCZ0F		Compact, wide gap, size: 3.7 × 2.0 × 2.7 mm	1.7	0.3	1.0	5	5	–	–	–	–
GP1S195HCZSF GP1S195HCPSF		Compact, wide gap, surface mount compatible, size: 3.5 × 2.0 × 2.7 mm	1.5	0.3	1.0	5	5	–	–	–	–
GP1S196HCZ0F		Compact, Low profile (3.1 × 2.0 × 2.7 mm)	1.1	0.3	2.0	5	5	50	0.1	1 000	5
GP1S196HCZSF		Surface mount, for soldering reflow, compact, low profile (3.1 × 2.0 × 2.7 mm)	1.1	0.3	2.0	5	5	50	0.1	1 000	5
GP1S97J0000F▲		High resolution, wide gap, with mounting hole, PWB mounting type	2.2	0.3	1.6	5	5	50	0.1	1 000	5
GP1S097HCZ0F		High resolution, wide gap, with mounting hole (4.5 × 2.6 × 4.5 mm)	2.0	0.3	2.0	5	5	50	0.1	1 000	5
GP1S39J0000F▲		PWB mounting type, two-phase output type	1.5	0.6 <sup>*1</sup>	3.3	4	5	50	0.1	1 000	5

\* Topr: -25 to +85 °C

\*1 Reading pitch

The model marked with ▲ may not be available in the near future. Contact with SHARP for details before use.

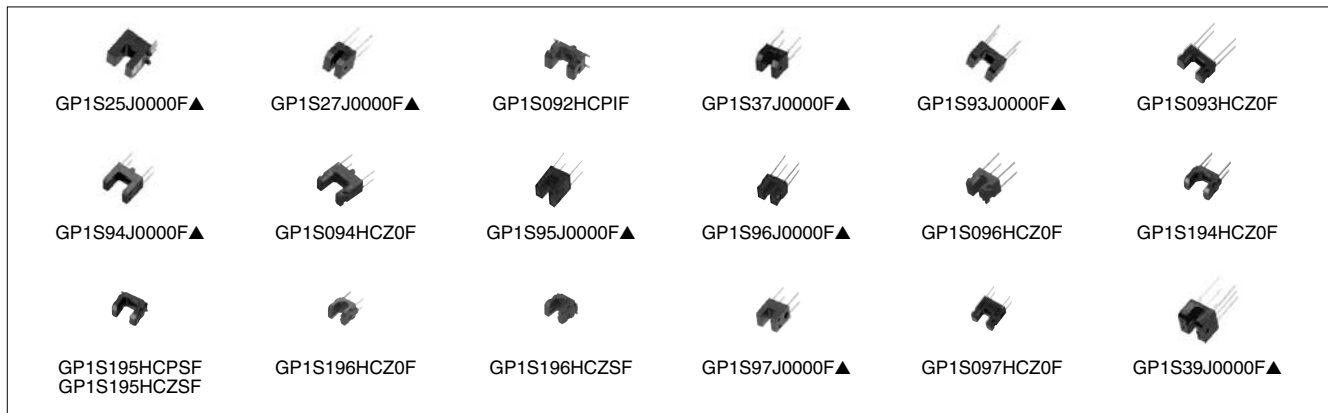

#### Notice

In the absence of confirmation by device specification sheets, SHARP takes no responsibility for any defects that may occur in equipment using any SHARP devices shown in catalogs, data books, etc. Except where specially indicated, models listed on this page comply with the RoHS Directive\*. For details, please contact SHARP. \*RoHS Directive: Prohibits use of lead, cadmium, hexavalent chromium, mercury and specific brominated flame retardants (PBBs and PBDEs), with certain exceptions. Contact SHARP in order to obtain the latest device specification sheets before using any SHARP device.



### <Case type>

(Ta = 25°C)

Model No.	Internal connection diagram	Features	Detecting and emitting gap (mm)	Slit width (mm)	Electro-optical characteristics						
					Current transfer ratio			Response time			
					CTR (%) MIN.	IF (mA)	VCE (V)	tr (μs) TYP.	IC (mA)	RL (Ω)	VCE (V)
GP1S566VJ00F		Long case, snap-in mounting type	3.0	0.5	2.5	20	5	3	2	100	2
GP1S50J0000F		High resolution, both-side mounting type	3.0	0.5	2.5	20	5	3	2	100	2
GP1S51VJ000F*1		High resolution, side mounting type	3.0	0.5	2.5	20	5	3	2	100	2
GP1S52VJ000F*1		High resolution, PWB mounting type	3.0	0.5	2.5	20	5	3	2	100	2
GP1S53VJ000F		High resolution, PWB mounting type	5.0	0.5	2.5	20	5	3	2	100	2
GP1S54J0000F		High resolution, with positioning pin, PWB mounting type	3.0	0.5	2.5	20	5	3	2	100	2
GP1S56TJ000F		High resolution, with positioning pin, PWB mounting type	2.0	0.15	2.0	20	5	38	0.5	1 000	2
GP1S58VJ000F		High resolution, with positioning pin, PWB mounting type	5.0	0.5	2.5	20	5	3	2	100	2
GP1S59J0000F		High resolution, horizontal slit, with positioning pin, PWB mounting type	4.2	0.5	2.5	20	5	3	2	100	2
GP1S525VJ00F		Short lead type with easy board mounting, horizontal slit, high precision positioning (lead: within ø1.2 mm)	5.0	0.5	3.25	20	10	3	2	100	2

\* Topr: -25 to +85 °C

\*1 High reliability types: GP1SQ51VJ00F, and GP1SQ52J000F are also available.

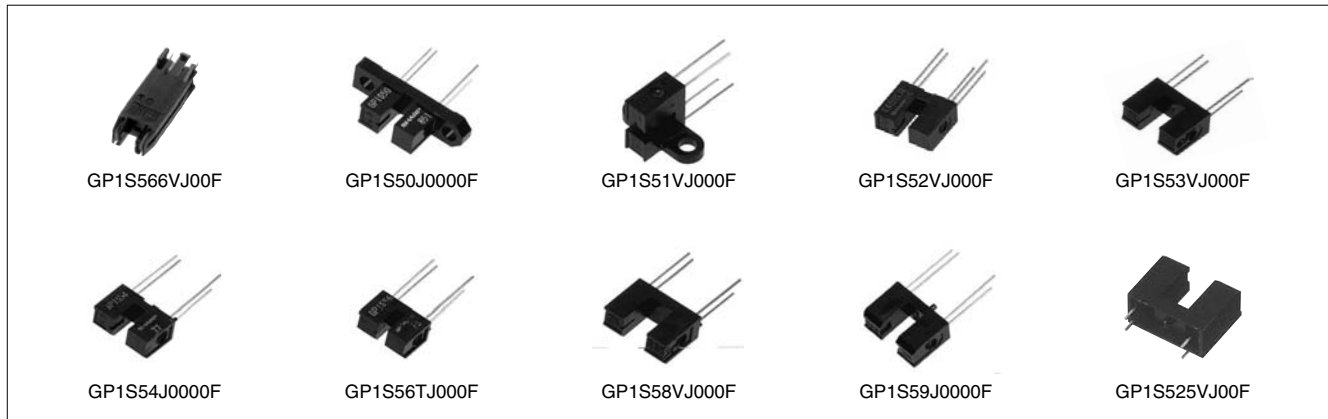

### <With connector type>

(Ta = 25°C)

Model No.	Internal connection diagram	Features	Detecting and emitting gap (mm)	Slit width (mm)	Electro-optical characteristics						
					Current transfer ratio			Response time			
					CTR (%) MIN.	IF (mA)	VCE (V)	tr (μs) TYP.	IC (mA)	RL (Ω)	VCE (V)
GP1S74PJ000F		Snap-in mounting type with connector Applicable to 3 kinds of thickness of mounting boards	5.0	0.5	2.5	20	5	3	2	100	2

\* Topr: -25 to +85 °C



#### Notice

In the absence of confirmation by device specification sheets, SHARP takes no responsibility for any defects that may occur in equipment using any SHARP devices shown in catalogs, data books, etc.  
 Except where specially indicated, models listed on this page comply with the RoHS Directive\*. For details, please contact SHARP.  
 \*RoHS Directive: Prohibits use of lead, cadmium, hexavalent chromium, mercury and specific brominated flame retardants (PBBs and PBDEs), with certain exceptions.  
 Contact SHARP in order to obtain the latest device specification sheets before using any SHARP device.

## ◆Darlington phototransistor output <Case type>

(Ta = 25°C)

Model No.	Internal connection diagram	Features	Detecting and emitting gap (mm)	Slit width (mm)	Electro-optical characteristics						
					Current transfer ratio			Response time			
					CTR (%) MIN.	IF (mA)	VCE (V)	tr (μs) TYP.	IC (mA)	RL (Ω)	VCE (V)
GP1L50J000F		High resolution, both-side mounting type	3.0	0.5	50	1	2	80	2	100	2
GP1L51J000F		High resolution, side mounting type	3.0	0.5	50	1	2	80	2	100	2
GP1L52VJ000F		High resolution, PWB mounting type	3.0	0.5	50	1	2	80	2	100	2
GP1L53VJ000F		High resolution, PWB mounting type	5.0	0.5	30	1	2	80	2	100	2
GP1L57J000F		Wide gap, PWB mounting type	10.0	1.8	70	1	2	130	2	100	2

\* Topr: -25 to +85 °C



## ◆OPIC type ( "OPIC" (Optical IC) is a trademark of SHARP Corporation. An OPIC consists of a light-detecting element and signal-processing circuit integrated onto a single chip. ) <Compact type>

(Ta = 25°C)

Model No.	Internal connection diagram	Features	Detecting and emitting gap (mm)	Slit width (mm)	Electro-optical characteristics							
					Threshold input current			Propagation delay time				
					IFLH (mA) MAX.	IFHL (mA) MAX.	VCC (V)	tPLH (μs) TYP.	tPHL (μs) TYP.	IF (mA)	RL (Ω)	VCC (V)
GP1A91LRJ00F▲		Compact, PWB mounting, low operating voltage (1.4 V to 7.0 V)	1.2	(0.23) *1	-	3.5	3	10.0	3.0	5	3 000	3
GP1A91LCJ00F▲		Compact, PWB mounting, low operating voltage (1.4 V to 7.0 V)	1.2	(0.23) *1	-	3.5	3	10.0	3.0	5	2 500	3
☆GP1A98HCZ0F		Compact, PWB mounting	3.0	0.5	8	-	3.3 to 24	10.0	2.0	10	3 900 to 20 000	3.3 to 24

\* Topr = -25 to +85°C

\*1 Resolution of detecting portion

The model marked with ▲ may not be available in the near future. Contact with SHARP for details before use.

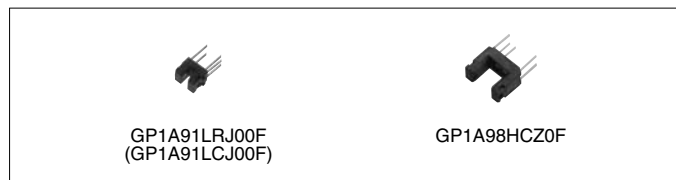

### Notice

In the absence of confirmation by device specification sheets, SHARP takes no responsibility for any defects that may occur in equipment using any SHARP devices shown in catalogs, data books, etc.  
 Except where specially indicated, models listed on this page comply with the RoHS Directive\*. For details, please contact SHARP.  
 \*RoHS Directive: Prohibits use of lead, cadmium, hexavalent chromium, mercury and specific brominated flame retardants (PBBs and PBDEs), with certain exceptions.  
 Contact SHARP in order to obtain the latest device specification sheets before using any SHARP device.





### <Case type>

(Ta = 25°C)

Model No.	Internal connection diagram	Features	Detecting and emitting gap (mm)	Slit width (mm)	Electro-optical characteristics							
					Threshold input current			Propagation delay time				
					IFLH (mA) MAX.	IFHL (mA) MAX.	VCC (V)	tPLH (μs) TYP.	tPHL (μs) TYP.	IF (mA)	RL (Ω)	VCC (V)
GP1A50HRJ00F		Both-side mounting type	3.0	0.5	5	–	5	3	5	5	280	5
GP1A51HRJ00F		Side mounting type	3.0	0.5	5	–	5	3	5	5	280	5
GP1A52HRJ00F		PWB mounting type	3.0	0.5	5	–	5	3	5	5	280	5
GP1A53HRJ00F		PWB mounting type	5.0	0.5	8	–	5	3	5	8	280	5
GP1A57HRJ00F		PWB mounting type, with positioning pin	10.0	1.8	7	–	5	3	5	7	280	5
GP1A58HRJ00F		PWB mounting type, with positioning pin	5.0	0.5	8	–	5	3	5	8	280	5
GP1A52LRJ00F		PWB mounting type	3.0	0.5	–	5	5	5	3	5	280	5

\* Topr = -25 to +85°C



GP1A50HRJ00F

GP1A51HRJ00F

GP1A52LRJ00F  
(GP1A52HRJ00F)

GP1A53HRJ00F  
(GP1A58HRJ00F with positioning pin)

GP1A57HRJ00F

#### Notice

In the absence of confirmation by device specification sheets, SHARP takes no responsibility for any defects that may occur in equipment using any SHARP devices shown in catalogs, data books, etc.  
 Except where specially indicated, models listed on this page comply with the RoHS Directive\*. For details, please contact SHARP.  
 \*RoHS Directive: Prohibits use of lead, cadmium, hexavalent chromium, mercury and specific brominated flame retardants (PBBs and PBDEs), with certain exceptions.  
 Contact SHARP in order to obtain the latest device specification sheets before using any SHARP device.





◆ **OPIC type** (“OPIC” (Optical IC) is a trademark of SHARP Corporation. An OPIC consists of a light-detecting element and signal-processing circuit integrated onto a single chip.)

<With 3-pin connector terminal>

(Ta = 25°C)

Model No.	Internal connection diagram	Features	Detecting and emitting gap (mm)	Slit width (mm)	Electro-optical characteristics					
					Supply voltage V <sub>CC</sub> (V)		V <sub>OL</sub> (V) MAX.	Low level output voltage		
					MIN.	MAX.		Light cut-off	I <sub>OL</sub> (mA)	V <sub>CC</sub> (V)
GP1A05AJ000F		Either-side mounting type	5.0	0.5	4.5	5.5	0.35	No	16	5
GP1A05A2J00F		Either-side mounting type	5.0	0.5	4.5	5.5	0.35	No	16	5
GP1A05A5J00F		Either-side mounting type	5.0	0.5	4.5	5.5	0.35	No	16	5
GP1A73AJ000F		Compact, snap-in mounting type	5.0	0.5	4.5	5.5	0.35	No	4	5
GP1A073LCS		Compact, snap-in mounting type, low voltage operation	5.0	0.5	2.7	5.5	0.35	No	4	5
GP1A75EJ000F		Either-side mounting type	5.0	0.5	4.5	5.5	0.35	Yes	16	5
GP1A05EJ000F		Either-side mounting type	5.0	0.5	4.5	5.5	0.4	Yes	16	5
GP1A05E2J00F		Screw mounting type	5.0	0.5	4.5	5.5	0.4	Yes	16	5

\* Topr: -20 to +75°C



## ■ Photointerrupters

<Reflective type>

◆ **Single Phototransistor output**

<Compact>

(Ta = 25°C)

Model No.	Internal connection diagram	Features	Focal distance (mm)	Electro-optical characteristics							
				Current transfer ratio			Response time				
				CTR (%) MIN.	I <sub>F</sub> (mA)	V <sub>CE</sub> (V)	t <sub>r</sub> (μs) TYP.	I <sub>C</sub> (mA)	R <sub>L</sub> (Ω)	V <sub>CE</sub> (V)	
GP2S24J0000F		Compact (DIP), visible light cut-off	0.7	0.5	4	2	20	0.1	1 000	2	
GP2S27J0000F		Compact, allow reflow soldering, visible light cut-off	0.7	0.5	4	2	20	0.1	1 000	2	
GP2S40J0000F		Compact, long focal distance, visible light cut-off	3	2.5	20	5	50	0.1	1 000	2	
GP2S700HCP		Compact, long focal distance, surface mounting leadless type	3	1.5	4	2	20	0.1	1 000	2	
GP2S60		Thin (3.2 × 1.7 × t: 1.1 mm), leadless type	(0.5)	1.75 <sup>*1</sup> TYP.	4	2	20	0.1	1 000	2	

\* Topr: -25 to +85°C

\*1 Detection area

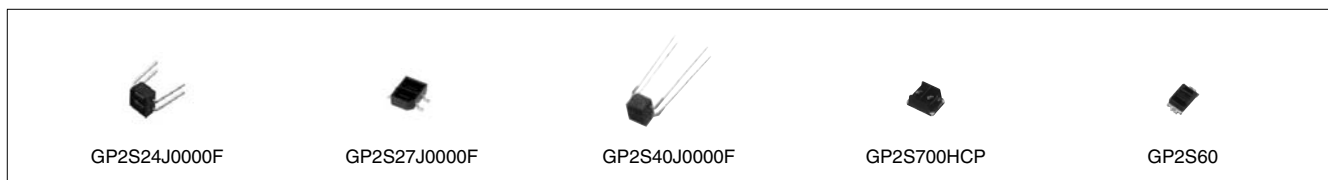

### Notice

In the absence of confirmation by device specification sheets, SHARP takes no responsibility for any defects that may occur in equipment using any SHARP devices shown in catalogs, data books, etc. Except where specially indicated, models listed on this page comply with the RoHS Directive\*. For details, please contact SHARP. \*RoHS Directive: Prohibits use of lead, cadmium, hexavalent chromium, mercury and specific brominated flame retardants (PBBs and PBDEs), with certain exceptions. Contact SHARP in order to obtain the latest device specification sheets before using any SHARP device.



## ◆Darlington Phototransistor output <Compact>

(Ta = 25°C)

Model No.	Internal connection diagram	Features	Focal distance (mm)	Electro-optical characteristics							
				Current transfer ratio			Response time				
				CTR (%) MIN.	IF (mA)	VCE (V)	tr (μs) TYP.	Ic (mA)	RL (Ω)	VCE (V)	
GP2L24J0000F		Compact (DIP), visible light cut-off	0.7	12.5	4	2	80	10	100	2	



## ◆OPIC output ( "OPIC" (Optical IC) is a trademark of SHARP Corporation. An OPIC consists of a light-detecting element and signal-processing circuit integrated onto a single chip. ) <With 3-pin connector terminal>

(Ta = 25°C)

Model No.	Internal connection diagram	Features	Optimum detecting distance (mm)	Electro-optical characteristics					
				Supply voltage Vcc (V)		Dissipation current Icc (mA) MAX.	Low level output voltage		
				MIN.	MAX.		Vcc (V)	VoL (V) MAX.	Vcc (V)
GP2A22J0000F▲		Multi types of paper detectable, light modulation type, with connector, sensitivity adjusted	9 to 15	4.75	5.25	30*1	5	0.4	5
GP2A200LCS0F		Multi types of paper detectable, light modulation type, with connector, sensitivity adjusted	5 to 15	4.75	5.25	30*1	5	0.4	5
GP2A240LCS0F		Improved light-resistance characteristic for inverter lighting (500 lx), light modulation type, connector output	5 to 15	4.75	5.25	30*1	5	0.4	5
GP2A250LCS0F		Static electricity resistant, improved light-resistance characteristic for inverter lighting (500 lx), light modulation type, connector output	5 to 15	4.75	5.25	30*1	5	0.4	5
GP2A25J0000F		Multi types of paper detectable, light modulation type, with connector, sensitivity adjusted	3 to 7	4.75	5.25	30*1	5	0.4	5
GP2A231LRS0F		Compact, Hook type, Multi types of paper detectable, light modulation type, with connector, sensitivity adjusted	3 to 7	4.75	5.25	20*1	5	0.4	5
GP2A25NJ000F		Multi types of paper detectable, light modulation type, sensitivity adjusted, applicable to inverter fluorescent lamp, built-in visible light cut filter	3 to 6	4.75	5.25	30*1	5	0.4	5
GP2A25BJ000F		Multi types of paper detectable, light modulation type, with connector, sensitivity adjusted	3 to 7	4.75	5.25	30*1	5	0.4	5
GP2A28AJ000F		Multi types of paper detectable, light modulation type, with connector, sensitivity adjusted, detecting portion with flat configuration	3 to 7	4.75	5.25	30*1	5	0.4	5

\* Top: -10 to +60°C (GP2A22J0000F, GP2A25J0000F, GP2A25BJ000F)

\*1 Smoothing value RL = ∞

The model marked with ▲ may not be available in the near future. Contact with SHARP for details before use.

[Internal connection diagram]

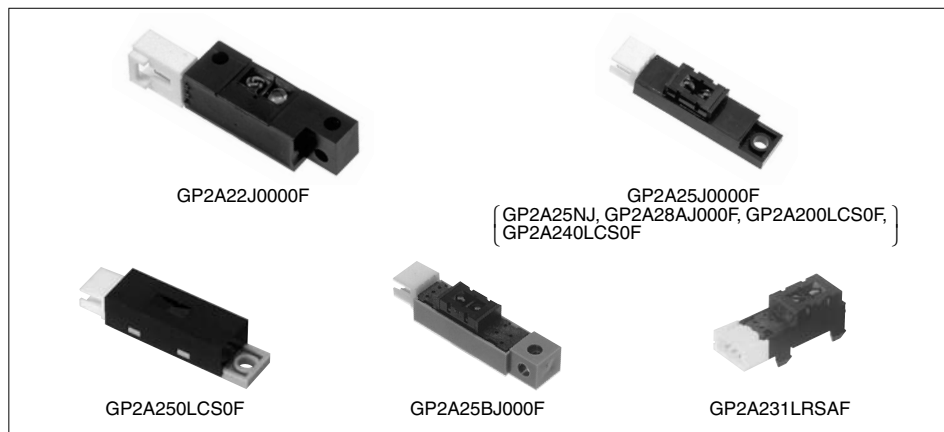
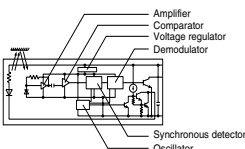

### Notice

In the absence of confirmation by device specification sheets, SHARP takes no responsibility for any defects that may occur in equipment using any SHARP devices shown in catalogs, data books, etc. Except where specially indicated, models listed on this page comply with the RoHS Directive\*. For details, please contact SHARP. \*RoHS Directive: Prohibits use of lead, cadmium, hexavalent chromium, mercury and specific brominated flame retardants (PBBs and PBDEs), with certain exceptions. Contact SHARP in order to obtain the latest device specification sheets before using any SHARP device.



## Photointerrupters for Specific Applications

### ◆ Transmissive type

#### <Single phototransistor output type with actuator and 3-pin connector terminal>

(Ta = 25°C)

Model No.	Internal connection diagram	Features	Actuator lever starting torque (Initial) MAX.	Electro-mechanical characteristics*1									
				Light beam interrupted					Light beam uninterrupted				
				Dissipation current		Collector current			Dissipation current		Collector current		
				Icc1 (mA)	Vcc (V)	Ic1 (μA)	Vcc (V)	Vo (V)	Icc2 (mA)	Vcc (V)	Ic2 (mA)	Vcc (V)	Vo (V)
GP1S44S1J00F		Spring lever type actuator United with connector	$1 \times 10^{-4}$ N•m or less	20 MAX.	5	50 MAX.	5	5	20 MAX.	5	0.25 MIN.	5	5

\* Topr: -25 to +75 °C

\*1 Operating voltage: 4.5 to 5.5 V



#### <OPIC type with actuator and 3-pin connector terminal>

(Ta = 25°C)

Model No.	Internal connection diagram	Features	Absolute maximum ratings		Electro-mechanical characteristics	Electro-mechanical characteristics*1										
			Supply voltage Vcc (V)	Output current IOL (mA)		Actuator lever starting torque	Light beam interrupted					Light beam uninterrupted				
							Dissipation current		Low level output voltage			Dissipation current		High level output voltage		
							Iccl (mA)	Vcc (V)	VOL (V)	Vcc (V)	IOL (mA)	Icch (mA)	Vcc (V)	VOH (V)	Vcc (V)	RL (kΩ)
GP1A44E1J00F		Spring lever type actuator, United with connector	10	50	$1 \times 10^{-4}$ N•m or less	20 MAX.	5	0.4 MAX.	5	16	20 MAX.	5	Vcc × 0.9 MIN.	5	47	

\* Topr: -25 to +75 °C

\*1 Operating voltage: 4.5 to 5.5 V



#### Notice

In the absence of confirmation by device specification sheets, SHARP takes no responsibility for any defects that may occur in equipment using any SHARP devices shown in catalogs, data books, etc.  
 Except where specially indicated, models listed on this page comply with the RoHS Directive\*. For details, please contact SHARP.  
 \*RoHS Directive: Prohibits use of lead, cadmium, hexavalent chromium, mercury and specific brominated flame retardants (PBBs and PBDEs), with certain exceptions.  
 Contact SHARP in order to obtain the latest device specification sheets before using any SHARP device.



### <Compact, 2-phase phototransistor output type>

(Ta = 25°C)

Model No.	Internal connection diagram	Features	Electro-optical characteristics						
			Current transfer ratio			Response time			
			CTR (%) MIN.	IF (mA)	VCE (V)	tr (μs) TYP.	IC (mA)	RL (Ω)	VCE (V)
GP1S36J0000F▲		Built-in ball (2 phase output), compact, PWB mounting type	1.2	5	5	50	0.1	1 000	5
GP1S036HEZ▲		Built-in ball (2 phase output), compact, PWB mounting type, 4-direction detection	1.1	5	5	50	0.1	1 000	5

\* Topr: -25 to +85 °C

The model marked with ▲ may not be available in the near future. Contact with SHARP for details before use.

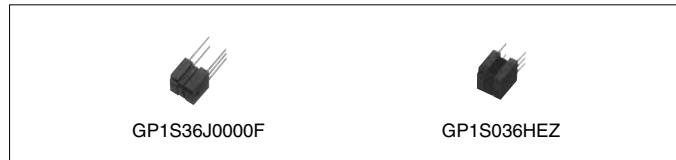

### <Case type, with encoder function>

(Ta = 25°C)

Model No.	Absolute maximum ratings			Electro-optical characteristics				
	Vcc (V)	Topr (°C)	Operating voltage Vcc (V)	Output signal	Resolution	Response frequency (kHz) MAX.	IF (mA)	Dissipation current (output side) Icc (mA) MAX.
GP1A30RJ000F▲	7	0 to +70	4.5 to 5.5	Phase A (Digital output) Phase B (Digital output)	Disk slit pitch 0.7 (mm)	5	30	20
GP1A038RBK0F*1, *3	7	0 to +70	2.7 to 5.5		Linear scale slit pitch 0.17 (mm)	20	11	5
GP1A038RCK0F*1, *3	7	0 to +70	2.7 to 5.5		Linear scale slit pitch 0.14 (mm)	20	11	5
GP1A037RDKJF*1, *3	7	0 to +70	2.7 to 5.5		Linear scale slit pitch 0.0847 (mm)	40	25	10
GP1A044RCKLF*1	—	-10 to +60	2.7 to 5.5		Linear scale slit pitch 0.14 (mm)	20	15	5
GP1A046RBZLF*1	—	-10 to +60	2.7 to 5.5		Linear scale slit pitch 0.17 (mm)	20	20	5
GP1A047RBZLF	—	0 to +60	2.7 to 5.5		Linear scale slit pitch 0.17 (mm)	20	20	7
GP1A047RDZLF	—	-10 to +60	2.7 to 5.5		Linear scale slit pitch 0.0847 (mm)	120	20	7

\*1 High precision read and low affection of angle error from vibration thanks to the multi-segment PD system

\*2 Duty ratio: 50±10%, phase difference: 90±30°

\*3 Duty ratio: 50±20%, phase difference: 90±45°

The model marked with ▲ may not be available in the near future. Contact with SHARP for details before use.



#### Notice

In the absence of confirmation by device specification sheets, SHARP takes no responsibility for any defects that may occur in equipment using any SHARP devices shown in catalogs, data books, etc.

Except where specially indicated, models listed on this page comply with the RoHS Directive\*. For details, please contact SHARP. \*RoHS Directive: Prohibits use of lead, cadmium, hexavalent chromium, mercury and specific brominated flame retardants (PBBs and PBDEs), with certain exceptions.

Contact SHARP in order to obtain the latest device specification sheets before using any SHARP device.



## ◆ Reflective type

### <Case type, phototransistor output>

(Ta = 25°C)

Model No.	Internal connection diagram	Features	Focal distance (mm)	Electro-optical characteristics							
				Current transfer ratio			Response time				
				CTR (%) MIN.	IF (mA)	VCE (V)	tr (μs) TYP.	Ic (mA)	RL (Ω)	VCE (V)	
GP2S29SJ000F		Long focal distance (with prism system), compact, screw mounting type	*1	1.0*1	20	5	38	0.5	1 000	2	

\* Topr: -25 to +85°C

\*1 Space between prism and sensor is 8 mm.



### <For the amusement industry>

(Ta = 25°C)

Model No.	Features	Electro-optical characteristics		
		Supply voltage Vcc	Dissipation current Icc (mA)	Response frequency f (Hz)
GP2A221HRKA	Employs reflective type, pinball detector, connector with lock	4.5 to 15	MAX. 10	MAX. 500
GP2A222HCKA	Employs reflective type, pinball detector, connector with lock In conjunction with an IC, detects beam interruption*1	4.5 to 16.5	MAX. 10	MAX. 500

\*1 Used together with interface IC for control (IR3N184)



#### Notice

In the absence of confirmation by device specification sheets, SHARP takes no responsibility for any defects that may occur in equipment using any SHARP devices shown in catalogs, data books, etc.  
 Except where specially indicated, models listed on this page comply with the RoHS Directive\*. For details, please contact SHARP.  
 \*RoHS Directive: Prohibits use of lead, cadmium, hexavalent chromium, mercury and specific brominated flame retardants (PBBs and PBDEs), with certain exceptions.  
 Contact SHARP in order to obtain the latest device specification sheets before using any SHARP device.



## ■ Phototransistor Lineup

Package	Output type	Features	Half sensitivity angle	Model No.	
				Standard	Visible light cut-off
Epoxy resin with lens (ø3 mm)	Single phototransistor	General purpose	±20°	PT380	PT380F
	Darlington phototransistor	High sensitivity	±20°	PT381	PT381F
Epoxy resin with lens	Single phototransistor	General purpose/Narrow acceptance	±13°	PT480E0000F	PT480FE0000F
		Compact, thin	±35°	PT4800E0000F	PT4800FE000F / PT4850FE000F
	Darlington phototransistor	High sensitivity/Narrow acceptance	±13°	PT481E0000F	PT481FE0000F
		High sensitivity/Narrow acceptance/Long lead	±13°	—	PT483F1E000F
		High sensitivity/Compact, thin	±35°	PT4810E0000F	PT4810FE000F
		High sensitivity/Intermediate acceptance	±40°	—	PT491FE0000F
		High sensitivity/Intermediate acceptance/Long lead	±40°	—	PT493FE0000F
TO-18	Single phototransistor	Narrow acceptance	±6°	PT501 ▲	—
		Narrow acceptance/With base terminal	±6°	PT510 ▲	—
	Darlington phototransistor	Narrow acceptance/With base terminal	±6°	PT550 ▲	—
		Wide acceptance/With base terminal	±50°	PT550F ▲	—
Surface mounting leadless type	Single phototransistor	Compact	±60°	PT600T	—
		Compact (surface mounting type)	±70°	PT200MC0NP	—
		Compact (infrared cut type)	±60°	PT202MR0MP1	—
	Darlington phototransistor	Compact (side view/top view mounting possible)	±15°	PT100MC0MP	PT100MF0MP
		Compact	±60°	PT601T	—
		Compact (side view/top view mounting possible)	±15°	—	PT100MF1MP
		Compact (side view/top view mounting possible)	±15°	—	PT100MF1MP

The model marked with ▲ may not be available in the near future. Contact with SHARP for details before use.

# PHOTOTRANSISTORS



## Phototransistors

(Ta = 25°C)

Type	Model No.	Package	Absolute maximum ratings			Ic (mA)				ICEO(A)		Dq (°) TYP.	λp (nm) TYP.
			VCEO (V)	Pc (mW)	Topr (°C)	MIN.	MAX.	VCE (V)	Ee (mW/cm²)	MAX.	VCE (V)		
Single	PT380	ø3 epoxy resin	35	50	-25 to +85	0.16	1.17	5	Ev, 100 lx	1 × 10 <sup>-7</sup>	20	±20	800
	PT380F*1		35	50	-25 to +85	0.095	0.9	5	Ev, 100 lx	1 × 10 <sup>-7</sup>	20	±20	860
	PT600T	Surface mounting leadless type	35	50	-25 to +85	0.7	TYP. 3.5	5	5	1 × 10 <sup>-7</sup>	20	±60	880
	PT200MC0NP		50	50	-25 to +85	0.016	0.059	5	0.1	1 × 10 <sup>-7</sup>	20	±70	930
	PT202MR0MP1*2		5	5	-30 to +85	—	TYP. 0.043	1.5	Ev, 100 lx	1 × 10 <sup>-7</sup>	1.5	±60	620
	PT100MC0MP		35	75	-30 to +85	1.7	5.1	5	1	1 × 10 <sup>-7</sup>	20	±15	900
	PT100MF0MP*1		35	75	-30 to +85	1.15	3.45	5	1	1 × 10 <sup>-7</sup>	20	±15	910
	PT480E0000F		Epoxy resin with lens	35	75	-25 to +85	0.4	TYP. 1.7	5	1	1 × 10 <sup>-7</sup>	20	±13
	PT480FE0000F*1	35		75	-25 to +85	0.25	TYP. 0.8	5	1	1 × 10 <sup>-7</sup>	20	±13	860
	PT4800E0000F	35		75	-25 to +85	0.12	TYP. 0.4	5	1	1 × 10 <sup>-7</sup>	20	±35	800
	PT4800FE0000F*1	35		75	-25 to +85	0.08	TYP. 0.25	5	1	1 × 10 <sup>-7</sup>	20	±35	860
	PT4850FE0000F*1		35	75	-25 to +85	0.12	0.56	5	1	1 × 10 <sup>-7</sup>	20	±35	860
PT501 ▲	TO-18	45	75	-25 to +125	2.5	TYP. 10	5	10	1 × 10 <sup>-7</sup>	30	±6	800	
PT510 ▲		35	75	-25 to +125	2.5	TYP. 20.0	5	10	1 × 10 <sup>-7</sup>	30	±6	800	
Darlington	PT381	ø3 epoxy resin	35	50	-25 to +85	0.12	1.5	10	Ev, 2 lx	1 × 10 <sup>-6</sup>	10	±20	800
	PT381F*1		35	50	-25 to +85	0.07	1.08	10	Ev, 2 lx	1 × 10 <sup>-6</sup>	10	±20	860
	PT481E0000F	Epoxy resin with lens	35	75	-25 to +85	1.5	25	2	0.1	1 × 10 <sup>-6</sup>	10	±13	800
	PT481FE0000F*1		35	75	-25 to +85	0.9	27	2	0.1	1 × 10 <sup>-6</sup>	10	±13	860
	PT4810E0000F		35	75	-25 to +85	0.45	7.0	2	0.1	1 × 10 <sup>-6</sup>	10	±35	800
	PT4810FJE000F*1		35	75	-25 to +85	0.27	6.0	2	0.1	1 × 10 <sup>-6</sup>	10	±35	860
	PT483F1E000F*1		35	75	-25 to +85	1.5	4.0	2	0.1	1 × 10 <sup>-6</sup>	10	±13	860
	PT491FE0000F*1		35	75	-25 to +85	0.2	0.8	2	Ev, 2 lx	1 × 10 <sup>-6</sup>	10	±40	860
	PT493FE0000F*1		35	75	-25 to +85	0.2	0.8	2	Ev, 2 lx	1 × 10 <sup>-6</sup>	10	±40	860
	PT550 ▲	TO-18	35	150	-25 to +125	3	TYP. 20.0	5	0.1	1 × 10 <sup>-6</sup>	10	±6	800
	PT550F ▲		35	150	-25 to +125	3	TYP. 20.0	5	1.0	1 × 10 <sup>-6</sup>	10	±50	800
	PT601T	Leadless chip type	35	50	-25 to +85	0.03	0.3	10	0.01	1 × 10 <sup>-6</sup>	10	±60	880
	PT100MF1MP*1	Surface mounting leadless type	35	75	-30 to +85	0.2	1.2	5	0.01	1 × 10 <sup>-6</sup>	10	±15	860

\*1 Visible light cut-off type

\*2 Infrared cut-off type

Note) Some products are handled by the Compound Semiconductor Division.

The model marked with ▲ may not be available in the near future. Contact with SHARP for details before use.

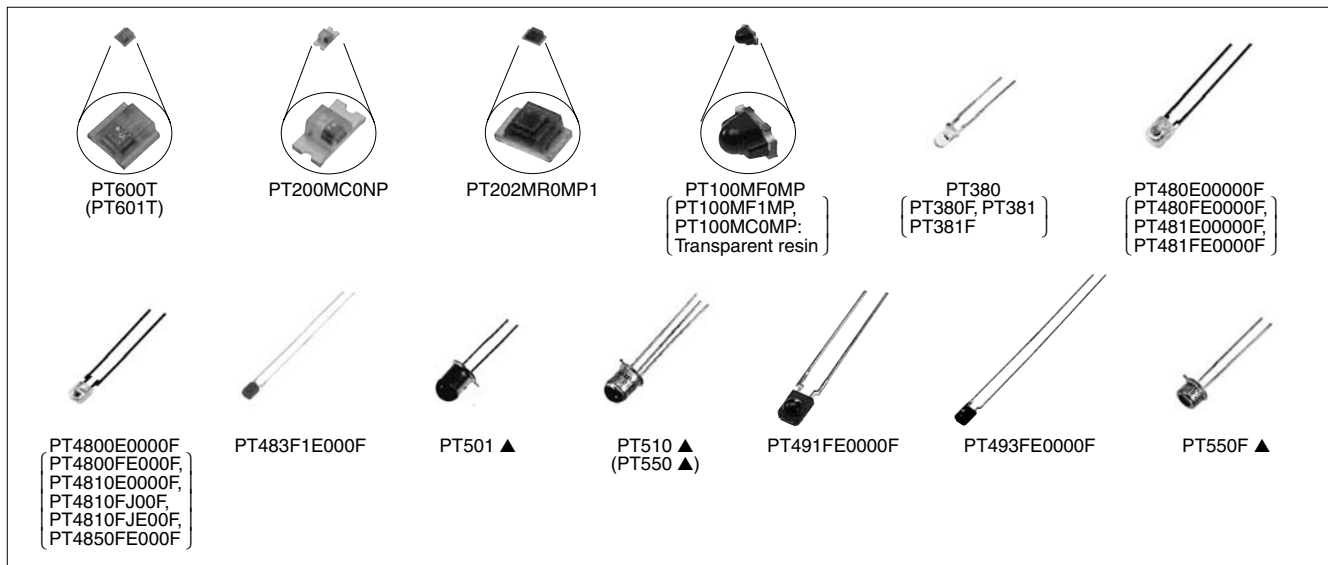

### Notice

In the absence of confirmation by device specification sheets, SHARP takes no responsibility for any defects that may occur in equipment using any SHARP devices shown in catalogs, data books, etc. Except where specially indicated, models listed on this page comply with the RoHS Directive\*. For details, please contact SHARP. \*RoHS Directive: Prohibits use of lead, cadmium, hexavalent chromium, mercury and specific brominated flame retardants (PBBs and PBDEs), with certain exceptions. Contact SHARP in order to obtain the latest device specification sheets before using any SHARP device.





## ■ PIN Photodiodes

(Ta = 25°C)

Model No.	Features	Package (Material)	Active area (mm <sup>2</sup> )	Topr (°C)	Isc (μA) MIN.	Ev (lx)	Id (A) MAX.	V <sub>R</sub> (V)	tr, tf (μs) TYP.			λ <sub>p</sub> (nm) TYP.
									V <sub>R</sub> (V)	R <sub>L</sub> (kΩ)	R <sub>L</sub> (kΩ)	
PD49PIE0000F▲*1	PIN type	Visible light cut-off epoxy resin	7.73	-25 to +85	2.4	100	3 × 10 <sup>-8</sup>	10	0.2	10	1	1 000
PD410PI2E00F*1		Visible light cut-off epoxy resin with condenser (lens)	3.31	-25 to +85	2.5	100	1 × 10 <sup>-8</sup>	10	0.2	10	1	1 000
PD411PI2E00F		Epoxy resin with transparent condenser (lens)	3.31	-25 to +85	5.0	100	1 × 10 <sup>-8</sup>	10	0.2	10	1	960
PD412PI2E00F*2		Epoxy resin with transparent condenser (lens)	3.31	-25 to +85	3.5	100	1 × 10 <sup>-8</sup>	10	0.25	10	1	800
PD413PI2E00F*1	PIN type IrDA1.0	Visible light cut-off epoxy resin with condenser (lens)	3.31	-25 to +85	MIN. 4.5 (TYP. 5.4)	100	1 × 10 <sup>-8</sup>	10	0.2	10	1	960
PD60T	Chip device type	Transparent resin	-	-25 to +85	TYP. 4	1 000	1 × 10 <sup>-8</sup>	10	0.1	10	1	960
PD100MC0MP	Surface mounting leadless type	Transparent epoxy resin board with lens	-	-30 to +85	0.6	100	1 × 10 <sup>-8</sup>	10	0.01	15	0.18	820
PD100MF0MP*1	Surface mounting leadless type	Visible light cut-off epoxy resin board with lens	-	-30 to +85	0.4	100	1 × 10 <sup>-8</sup>	10	0.01	15	0.18	850

\*1 Visible light cut-off type

\*2 Tape packaging type (PD412TNE00F)

The model marked with ▲ may not be available in the near future. Contact with SHARP for details before use.



## ■ PSD (Position Sensitive Detector)

(Ta = 25°C)

Model No.	Features	Package (Material)	Active area (mm <sup>2</sup> )	Topr (°C)	I <sub>L</sub> (μA) MIN.	Ev (lx)	Interelectrode resistance (kΩ) TYP.		tr, tf (μs) TYP.			Position detection error (μm) MAX.
							V <sub>R</sub> (V)	V <sub>R</sub> (V)	R <sub>L</sub> (kΩ)	R <sub>L</sub> (kΩ)		
PD3122FE000F▲	Position sensitive detector With mounting hole	Visible light cut-off epoxy resin	1.2 (1.0 × 1.2 mm)	-25 to +85	6.4	1 000	110 to 170	1	5	1	1	±25

Custom-made products (detecting portion changed products) are also available.

The model marked with ▲ may not be available in the near future. Contact with SHARP for details before use.



## ■ Blue Sensitive Photodiodes

(Ta = 25°C)

Model No.	Features	Package (Material)	Active area (mm <sup>2</sup> )	Topr (°C)	Isc (μA) MIN.	Ev (lx)	Id (A) MAX.	V <sub>R</sub> (V)	λ <sub>p</sub> (nm) TYP.



### Notice

In the absence of confirmation by device specification sheets, SHARP takes no responsibility for any defects that may occur in equipment using any SHARP devices shown in catalogs, data books, etc.

Except where specially indicated, models listed on this page comply with the RoHS Directive\*. For details, please contact SHARP. \*RoHS Directive: Prohibits use of lead, cadmium, hexavalent chromium, mercury and specific brominated flame retardants (PBBs and PBDEs), with certain exceptions.

Contact SHARP in order to obtain the latest device specification sheets before using any SHARP device.



☆New product



## ■ Laser Power Monitoring Photodiodes for Optical Disc System

(Ta = 25°C)

Model No.	Features	Package (Material)	Active area (mm)	Topr (°C)	Isc (mA) TYP.	Ev	Id (A) MAX.	VR	λp (nm) TYP.
						(lx)		(V)	
PD101SC0SS0F	High response speed (cut-off frequency: 400 MHz)	Transparent epoxy resin	ø0.8	-25 to +85	450	100	1 × 10 <sup>-9</sup>	5	820



## ■ RGB Color Sensor

(Ta = 25°C)

Model No.	Features	Package	Peak sensitivity wavelength (nm)			Light receiving sensitivity (A/W) TYP.			Topr (°C)
			Blue	Green	Red	Blue	Green	Red	
☆PD30CMC31MZ	RGB 3-color LED compatible 3PD structure Filter-on chip structure allows for both infrared light reducing characteristics and a more compact size (1.1 mm thick)	Surface mounting 3 x 4 mm	460	540	620	0.18	0.23	0.16	-40 to +85

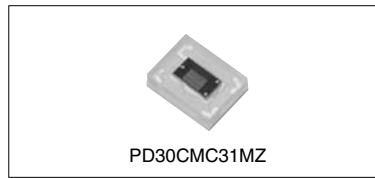

## ■ Ambient Light Sensors ( "OPIC" (Optical IC) is a trademark of the SHARP Corporation. An OPIC consists of a light-detecting element and signal-processing circuit integrated onto a single chip. )

(Ta = 25°C)

Model No.	Type	Package	Absolute maximum ratings				Electro-optical characteristics							
			Vcc (V)	P (mW)	Io (mA)	Topr (°C)	EVHL	EVHL	Vcc (V)	tPLH	tPHL	Vcc (V)	Ev (lx)	RL (Ω)
							(lx) MAX.	(lx) MAX.		(μs) TYP.	(μs) TYP.		(lx)	
IS485E	Built-in schmidt trigger circuit, amplifier and voltage regulator	Transparent epoxy resin with condenser (lens)	-0.5 to +17	175	50	-25 to +85	-	35	5	5	3	5	50	280
IS486E			-0.5 to +17	175	50	-25 to +85	35	-	5	3	5	50	280	



### Notice

In the absence of confirmation by device specification sheets, SHARP takes no responsibility for any defects that may occur in equipment using any SHARP devices shown in catalogs, data books, etc.  
 Except where specially indicated, models listed on this page comply with the RoHS Directive\*. For details, please contact SHARP.  
 \*RoHS Directive: Prohibits use of lead, cadmium, hexavalent chromium, mercury and specific brominated flame retardants (PBBs and PBDEs), with certain exceptions.  
 Contact SHARP in order to obtain the latest device specification sheets before using any SHARP device.



### <Low-voltage operation>

(Ta = 25°C)

Model No.	Type	Package	Absolute maximum ratings			Electro-optical characteristics								
			P (mW)	Io (mA)	Topr (°C)	Operating supply voltage (V)	EV <sub>LH</sub> (lx) MAX.	EV <sub>H</sub> (lx) MAX.	V <sub>CC</sub> (V)	t <sub>PHL</sub> (μs) TYP.	t <sub>PLH</sub> (μs) TYP.	V <sub>CC</sub> (V)	Ev (lx)	R <sub>L</sub> (Ω)
IS489E	Built-in Schmidt trigger circuit and amplifier	Transparent epoxy resin with condenser (lens)	80	2	-25 to +85	1.4 to 7.0	-	15	3	1.3	8.5	3	125	3 000



### <Model employing a light modulating system>

(Ta = 25°C)

Model No.	Type	Package	Absolute maximum ratings				Electro-optical characteristics*2						External disturbing light illuminance EvDx(lx) TYP.
			V <sub>CC</sub> (V)	P (mW)	Io (mA)	Topr (°C)	V <sub>OL</sub> (V) MAX.	V <sub>OH</sub> (V) MIN.	t <sub>PLH</sub> (μs) TYP.	t <sub>PHL</sub> (μs) TYP.	V <sub>CC</sub> (V)	R <sub>L</sub> (Ω)	
IS471FE*1, *3	Built-in pulse driver circuit at the emitter side, synchronous detector circuit, amplifier circuit and demodulator circuit	Visible light cut-off epoxy resin	-0.5 to +16	250	50	-25 to +60	0.35	4.97	400	400	5	280	7 000

\*1 IS471FE is less susceptible to disturbing effects thanks to the light modulation system

\*2 V<sub>CC</sub> = 5 V

\*3 Straight lead type (IS471FSE) is also available.



### <For laser beam printers (laser origin detection)>

(Ta = 25°C)

Model No.	Type	Package	Electro-optical characteristics			
			Recommended supply voltage V <sub>CC</sub> (V)	V <sub>OH</sub> (V) MIN.	V <sub>OL</sub> (V) MAX.	H → L delay time variation Δt <sub>PHL</sub> (ns) MAX.
GA220T2L1IZ	2PD, differential type	Transparent epoxy resin 18-pin	4.5 to 5.5	4.9	0.6	±8.5



#### Notice

In the absence of confirmation by device specification sheets, SHARP takes no responsibility for any defects that may occur in equipment using any SHARP devices shown in catalogs, data books, etc.

Except where specially indicated, models listed on this page comply with the RoHS Directive\*. For details, please contact SHARP. \*RoHS Directive: Prohibits use of lead, cadmium, hexavalent chromium, mercury and specific brominated flame retardants (PBBs and PBDEs), with certain exceptions.

Contact SHARP in order to obtain the latest device specification sheets before using any SHARP device.

# OPIC LIGHT DETECTORS

☆New product



## <Ambient light sensor>

(Ta = 25°C)

Model No.	Type	Package	Absolute maximum ratings			Electro-optical characteristics					
			Vcc (V)	Io (mA)	Topr (°C)	Recommended supply voltage Vcc (V)	Recommended illuminance range Ex (lx)	Current consumption Icc (μA) TYP.	Peak sensitivity wavelength λp (nm)	Io1 (μA) TYP.	Io2 (μA) TYP.
☆GA1A2S100SS	Built-in amplification circuit Peak sensitivity characteristic close to human visual sensitivity Output characteristic: Linear current output for illuminance Lead frame (straight) type	Transparent epoxy resin (3 × 4 mm)	7.0	5	-40 to +85	2.7 to 3.6	10 to 10 000	500	555	480 (at Ev = 1000 lx)	48 (at Ev = 100 lx)
☆GA1A2S100LY	Built-in amplification circuit Peak sensitivity characteristic close to human visual sensitivity Output characteristic: Linear current output for illuminance Lead frame (L bend) type		7.0	5	-40 to +85	2.7 to 3.6	10 to 10 000	500	555	480 (at Ev = 1000 lx)	48 (at Ev = 100 lx)
☆GA1A1S201WP	Built-in amplification circuit Peak sensitivity characteristic close to human visual sensitivity Output characteristic: Logarithmic current output for illuminance	Compact (2.0 mm × 1.6 mm) Leadless	7.0	1	-40 to +85	2.3 to 3.2	3 to 55 000	70	555	20 (at Ev = 100 lx)	30 (at Ev = 1000 lx)



GA1A2S100SS

GA1A2S100LY

GA1A1S201WP

### Notice

In the absence of confirmation by device specification sheets, SHARP takes no responsibility for any defects that may occur in equipment using any SHARP devices shown in catalogs, data books, etc.  
 Except where specially indicated, models listed on this page comply with the RoHS Directive\*. For details, please contact SHARP.  
 \*RoHS Directive: Prohibits use of lead, cadmium, hexavalent chromium, mercury and specific brominated flame retardants (PBBs and PBDEs), with certain exceptions.  
 Contact SHARP in order to obtain the latest device specification sheets before using any SHARP device.

☆New product



### <Optical disk devices for RF signal detection>

(Ta = 25°C)

Model No.	Type	Package	Absolute maximum ratings			Electro-optical characteristics					
			Vcc (V)	P (mW)	Topt (°C)	Icc (mA) TYP.	Vcc (V)	Response frequency fc*1 (MHz) TYP.	Vcc (V)	Output noise level Vn Main Ch. (dBm) TYP.	f (Hz)
IS1682Q	Built-in amplifier circuit, built-in RF addition amplifier (6-division PINPD + IC), for ×50 CD-ROM	Transparent 10-pin package	6.0	–	–30 to +80	14.8	5	(72/70) 72/70	5	–81	23.1M
GA250T6C3SY	Built-in amplifier circuit, for CD player Low operating voltage (MIN. 2.5 V)	Transparent 10-pin package	7.0	–	–20 to +75	6	5	5/0.3	5	(–78)	2.8M
GA250T6C4SY											
IS1623Q	Built-in amplifier circuit, (8-division PINPD + IC), switchable of sensitivity due to playback/recording mode for MD	Transparent flat 10-pin package	6.0	150	–20 to +70	4.2/ 4.6*2	3	5.3/3.8*2	3	–90	720k
IS1684Q	Built-in RF amplifier, for ×6 DVD-ROM drive	Transparent flat 10-pin package	6.0	–	–30 to +80	14.8	5	(70/60) 70/50	5	–81	23.1M
GA210TXV8SY▲*3	For 2-wavelength laser (For DVD player), 10-division PD pattern	Transparent flat 12-pin package (4 x 5.0 mm)	6.0	–	–10 to +70	17	5	–75	5	–80	23M
☆GA230TXW6SY	For ×16 DVD-R/RW, +R/W ultra-writable drive High-precision 3-step gain compatible	Transparent flat 14-pin package	6.0	–	–30 to +85	–	5	140	5	–	–
☆GA230TXR1ZY	DVD-ROM: for MAX. ×16 read only CD-ROM: for MAX. ×52 read only CD-R: for MAX. ×52 writable drive CD-RW: for MAX. ×32 writable drive	Transparent flat 14-pin package	6.0	–	–20 to +85	40	5	140	5	–80	72M
GA202TXV15K▲	For 2-wavelength laser (For DVD player), 10-division PD pattern	Transparent 12-pin package (3 x 4 mm)	6.0	–	–30 to +80	MAX. 19	5	57/57 50/50	5	–	–
GA202TXV15J		Gull wing lead Flat lead									
GA301TXW5MZ▲	For ×16 DVD-R/RW, +R/W ultra-writable drive For MAX. ×60 CD-R writable drive (For HiHi combo drive), settling time: 13 ns DVD-ROM: for MAX. ×16 read only, built-in bypass condenser for power supply, WPP system (Gain ×4 switching)	Leadless chip-type	6.0	–	–20 to +85	38	5	110	5	(–78)	72M

\*1 (RF/main) ... 650 nm, RF/main ... 780 nm

\*2 Playback/recording mode

\*3 We can supply custom orders for modified PD patterns, packages, and lead shapes for 2-wavelength laser compatible OPIC light detectors.

\*4 L gain mode/M gain mode

The model marked with ▲ may not be available in the near future. Contact with SHARP for details before use.

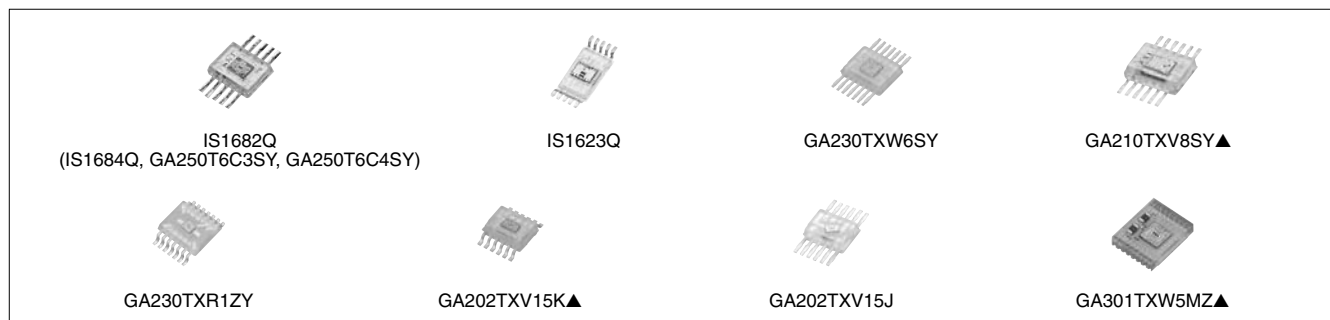

#### Notice

In the absence of confirmation by device specification sheets, SHARP takes no responsibility for any defects that may occur in equipment using any SHARP devices shown in catalogs, data books, etc.  
Except where specially indicated, models listed on this page comply with the RoHS Directive\*. For details, please contact SHARP.  
\*RoHS Directive: Prohibits use of lead, cadmium, hexavalent chromium, mercury and specific brominated flame retardants (PBBs and PBDEs), with certain exceptions.  
Contact SHARP in order to obtain the latest device specification sheets before using any SHARP device.

# OPIC LIGHT DETECTORS



## <Laser power monitoring diode for optical disc system>

(Ta = 25°C)

Model No.	Type	Package	Absolute maximum ratings			Electro-optical characteristics			
			Vcc (V)	P (mW)	Topr (°C)	Icc (mA) TYP.	Vcc (V)	fc (MHz) MIN.	Vcc (V)
GA104T1M1MZ▲	For x48 CD-R writable drive built-in amplifier circuit	Leadless chip-type [3.0 x 3.5 mm]	6.0	—	−20 to +70	20	5	50	5

\*1 Power monitoring photodiodes are also available. Please refer to the page for photodiodes.  
The model marked with ▲ may not be available in the near future. Contact with SHARP for details before use.



**Notice**

In the absence of confirmation by device specification sheets, SHARP takes no responsibility for any defects that may occur in equipment using any SHARP devices shown in catalogs, data books, etc.  
Except where specially indicated, models listed on this page comply with the RoHS Directive\*. For details, please contact SHARP.  
\*RoHS Directive: Prohibits use of lead, cadmium, hexavalent chromium, mercury and specific brominated flame retardants (PBBs and PBDEs), with certain exceptions.  
Contact SHARP in order to obtain the latest device specification sheets before using any SHARP device.



## ■ Infrared Emitting Diode Lineup

Type	Package	Features	Half intensity angle	Model No.
Single-end lead (Top view type)	Epoxy resin with lens (ø3 mm type)	General purpose	±13°	GL380
		High output type	±13°	GL381
		High speed signal transmission (12 MHz)	±17°	GL382
	Epoxy resin (Arch type)	General purpose	±18°	GL390
		Low forward voltage type	±18°	GL390V
Single-end lead (Side view type)	Epoxy resin with lens	General purpose/Narrow beam angle	±13°	GL480E0000F
		Compact and thin	±30°	GL4800E0000F
	Flat epoxy resin	Wide beam angle	±90°	GL4100E0000F
	Epoxy resin with lens	Compact package, bi-directional emitting type	Bidirectional	GL453E0000F ▲
Single-end lead (Top view type)	TO-18	High reliability	±50°	GL513F ▲
		High reliability/Narrow beam angle	±7°	GL514 ▲
	Epoxy resin with lens (ø5 mm type)	Low forward voltage type	±21°	GL560
		Low forward voltage type/Narrow beam angle	±13°	GL561
		High output type	±25°	GL537
		High output type/Narrow beam angle	±13°	GL538
Surface mount type	Leadless	Compact	±60°	GL610T
	Epoxy resin with lens/ leadless  (Mountable for Top view/ Side view type)	Compact/Narrow beam angle	±10°	GL100MN0MP
		High output type (Output: radiant flux/ radiant intensity indicated)	±10°/±9°	GL100MN1MP / GL100MN3MP
		Compact/Wide beam angle	±80°	GL100MD1MP1

The model marked with ▲ may not be available in the near future. Contact with SHARP for details before use.

# INFRARED EMITTING DIODES



## ■ Infrared Emitting Diodes

(Ta = 25°C)

Model No.	Package, features	Absolute maximum ratings				Φe (mW)			VF (V)			Δθ (°) TYP.	λp (nm) TYP.
		IF (mA)	VR (V)	P (mW)	Topr (°C)	MIN.	TYP.	IF (mA)	TYP.	MAX.	IF (mA)		
GL380	ø3 epoxy resin	60	6	150	-25 to +85	4.5*1	11*1	50	1.3	1.5	50	±13	950
GL381		60	6	150	-25 to +85	8.5*1	20*1	50	1.3	1.5	50	±13	950
GL382	ø3 epoxy resin, for high speed signal transmission:12 MHz	60	4	-	-25 to +85	6	18	50	1.5	1.7	50	±17	880
GL390	Arch type	60	6	150	-25 to +85	7*1	13*1	50	1.3	1.5	50	±18	950
GL390V		60	6	150	-25 to +85	9*1	16*1	50	1.3	1.5	50	±18	950
GL453E00000F ▲	Resin with bidirectional lens	50	6	75	-25 to +85	0.85	1.3	20	1.2	1.5	20	(Bidirectional)	950
GL480E00000F	Epoxy resin with lens	50	6	75	-25 to +85	0.7	-	20	1.2	1.4	20	±13	950
GL480E00000F		50	6	75	-25 to +85	0.7	1.6	20	1.2	1.4	20	±30	950
GL4100E0000F	Side-view flat type, Epoxy resin	50	6	75	-25 to +85	1.0	-	20	1.2	1.4	20	±90	950
GL513F ▲	TO-18	150	6	250	-40 to +125	1.44	2.88	100	1.35	1.6	100	±50	950
GL514 ▲		150	6	250	-40 to +125	3.31	5.35	100	1.35	1.6	100	±7	950
GL560	ø5 epoxy resin	100	6	150	-25 to +85	5*1	14*1	50	1.25	1.37	50	±21	940
GL561		100	6	150	-25 to +85	12*1	25*1	50	1.25	1.37	50	±13	940
GL537		100	6	150	-25 to +85	6*1	13*1	50	1.3	1.5	50	±25	950
GL538		100	6	150	-25 to +85	15*1	30*1	50	1.3	1.5	50	±13	950
GL610T	Leadless chip type	50	6	150	-25 to +85	0.7	2	20	1.3	1.5	50	±60	950
GL100MN0MP	Surface mounting leadless type, Epoxy resin board with lens	50	6	75	-30 to +85	1.0	3.0 (MAX.)	20	1.2	1.4	20	±10	940
GL100MN1MP	Surface mounting leadless type, Epoxy resin board with lens, high output type	50	6	75	-30 to +85	2.0	6.0 (MAX.)	20	1.2	1.5	20	±10	940
GL100MN3MP	Surface mounting leadless type, Epoxy resin board with lens, high output type	50	6	75	-30 to +85	3.0*1	6.0*1	20	1.25	1.5	20	±9	940
GL100MD1MP1	Surface mounting leadless type, Epoxy resin board with lens, wide beam angle	50	6	75	-30 to +85	-	6.0 (MAX.)	20	-	1.5	20	±80	940

\*1 Radiant intensity mW/sr

Note) Some products are handled by the Compound Semiconductor Division.

The model marked with ▲ may not be available in the near future. Contact with SHARP for details before use.

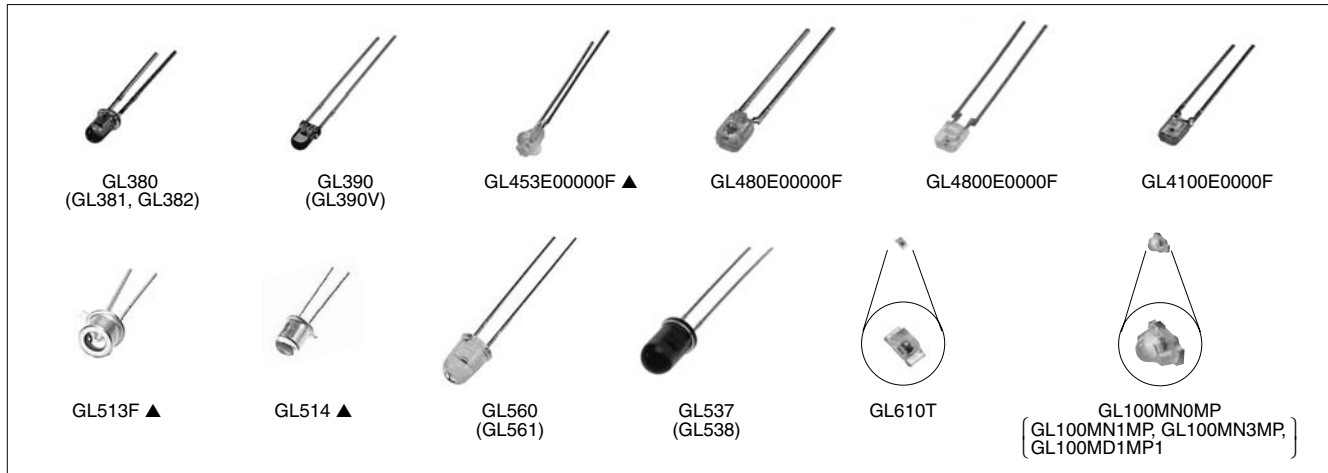

### Notice

In the absence of confirmation by device specification sheets, SHARP takes no responsibility for any defects that may occur in equipment using any SHARP devices shown in catalogs, data books, etc.

Except where specially indicated, models listed on this page comply with the RoHS Directive\*. For details, please contact SHARP. \*RoHS Directive: Prohibits use of lead, cadmium, hexavalent chromium, mercury and specific brominated flame retardants (PBBs and PBDEs), with certain exceptions.

Contact SHARP in order to obtain the latest device specification sheets before using any SHARP device.



## Distance Measuring Sensor Lineup

Output	Range of distance measuring	Features	Model No.	
1-bit digital output according to distance measuring	3 to 30 cm	1-bit digital output (detected distance: 15/17.5/13 cm)	GP2D150AJ00F/GP2D150MJ00F/GP2Y0D413K0F	
	10 to 80 cm	1-bit digital output (detected distance: 24 cm)	GP2D15J0000F	
	20 to 150 cm	1-bit digital output (detected distance: 80 cm)	General purpose	GP2Y0D21YK0F
				GP2Y0D02YK0F
			Battery drive compatible, compact, operating supply voltage (2.7 V to 6.2 V), 1-bit digital output (detected distance: 5/10 cm)	GP2Y0D805Z0F/GP2Y0D810Z0F
			Compact, thin 1-bit digital output (detected distance: 10/40 cm)	GP2Y0D310K/GP2Y0D340K
	Battery drive compatible, compact, operating supply voltage (2.7 V to 6.2 V), 1-bit digital output (detected distance: 1.5 cm) Capable of operation at high temperature	GP2Y5D91S00F		
Output according to distance measuring	4 to 30 cm	Analog voltage output	GP2D120XJ00F/GP2Y0A41SK0F	
	10 to 80 cm	Analog voltage output	GP2D12J0000F	
	20 to 150 cm	Analog voltage output	General purpose	GP2Y0A21YK0F
				GP2Y0A02YK0F
				GP2Y0A710K0F

## Wide Angle Sensor Lineup

Output	Range of distance measuring	Detection angle of view	Model No.
Voltage output according to distance measuring	4 to 30 cm	25° (When using 5 beams)	GP2Y3A001K0F
	20 to 150 cm	25° (When using 5 beams)	GP2Y3A002K0F
	40 to 300 cm	25° (When using 5 beams)	GP2Y3A003K0F

## High-Precision Displacement Sensor

Output	Range of distance measuring	Features	Model No.
Voltage output according to distance measuring	4.5 to 6.0 mm	Resolution: 50 μm	GP2Y0AH01K0F

## Paper Size Sensor (Using Optical Distance Measuring Method) Lineup

Output	Features	Model No.	
8-bit serial output	1-beam	GP2D06J0000F/GP2D061J000F/GP2D062J000F	
	2-beam	Thin type (T: 11 mm)	GP2Y2E101K0F
			GP2D03J0000F/GP2D032J0000F
	3-beam		GP2D07J0000F/GP2D071J000F/GP2D072J000F
		Thin type (T: 11 mm)	GP2Y2E301K0F
1-bit output	1-beam (detection height: 60 mm)	Thin type (T: 11.5 mm) GP2Y2D160K0F	
Analog output relative to measuring distance	1-beam (detection height: 80 mm)	Thin type (T: 11.5 mm) GP2Y2A180K0F	
	2-beam (detection height: 80 mm)	Thin type (T: 11.5 mm) GP2Y2A280K0F	

## Dust Sensor Unit Lineup

Output	Features	Model No.
Analog output	With peak-hold circuit	GP2U06J0000F
	Pulse analog output, single-shot detection of house dust, General purpose	GP2Y1010AU0F

## Color Toner Concentration (Deposition Amount) Sensor Lineup

Output	Features	Model No.
Analog output	Employs diffuse reflection system	GP2TC1J0000F
	Employs diffuse reflection system + mirror reflection system	GP2Y40010K0F



## Distance Measuring Sensors (1)

(Ta = 25°C)

Model No.	Features	Absolute maximum ratings		Electro-optical characteristics*1					
		V <sub>CC</sub> (V)	T <sub>opr</sub> (°C)	Distance measuring range (cm)	V <sub>OH</sub> (V) MIN.	V <sub>OL</sub> (V) MAX.	Dissipation current		Measured distance (cm)
							Operating (mA)	Standby (μA)	
GP2D12J0000F	Distance measuring sensor united with PSD*, infrared LED and signal processing circuit, Linear voltage output	-0.3 to +7	-10 to +60	10 to 80	V <sub>O</sub> (TYP.) = 0.4 V (at L = 80 cm), ΔV <sub>O</sub> (TYP.) = 2.0 V (at L: 80 cm → 10 cm)		MAX. 50	-	-
GP2Y0A21YK0F	Distance measuring sensor united with PSD*, infrared LED and signal processing circuit, Linear voltage output	-0.3 to +7	-10 to +60	10 to 80	V <sub>O</sub> (TYP.) = 0.4 V (at L = 80 cm), ΔV <sub>O</sub> (TYP.) = 1.9 V (at L: 80 cm → 10 cm)		MAX. 40	-	-
GP2D120XJ00F	Distance measuring sensor united with PSD*, infrared LED and signal processing circuit, Linear voltage output	-0.3 to +7	-10 to +60	4 to 30	V <sub>O</sub> (TYP.) = 0.4 V (at L = 30 cm), ΔV <sub>O</sub> (TYP.) = 2.25 V (at L = 30 cm → 4 cm)		MAX. 50	-	-
GP2Y0D805Z0F	Light detector, infrared LED and signal processing circuit, short distance measuring sensor unit, battery drive compatible (operating power supply: 2.7 to 6.2 V)	-0.3 to +7	-10 to +60	-	V <sub>CC</sub> -0.6	0.6	MAX. 6.5	MAX. 8	5
GP2Y0D810Z0F	Light detector, infrared LED and signal processing circuit, short distance measuring sensor unit, battery drive compatible (operating power supply: 2.7 to 6.2 V)	-0.3 to +7	-10 to +60	-	V <sub>CC</sub> -0.6	0.6	MAX. 6.5	MAX. 8	10
☆GP2Y5D91S00F	Light detector, infrared LED and signal processing circuit, short distance measuring sensor unit, battery drive compatible (operating power supply: 2.7 to 6.2 V), Capable of operation at high temperature	-0.3 to +7	-30 to +105	-	V <sub>CC</sub> -0.6	0.6	TYP. 7	-	1.5
GP2Y0D310K	Digital voltage output according to the measured distance of GP2Y0D340K	-0.3 to +7	-10 to +60	-	V <sub>CC</sub> -0.3	0.6	MAX. 35	-	10
GP2Y0D340K	Compact, thin type (15 x 9.6 x 8.7 mm: sensor part), Light detector, infrared LED and signal processing circuit, Digital voltage output according to the measured distance	-0.3 to +7	-10 to +60	-	V <sub>CC</sub> -0.3	0.6	MAX. 35	-	40
GP2D15J0000F	Distance measuring sensor united with PSD*, infrared LED and signal processing circuit, Digital voltage output	-0.3 to +7	-10 to +60	10 to 80	V <sub>CC</sub> -0.3	0.6	MAX. 50	-	24
GP2Y0D21YK0F	Distance measuring sensor united with PSD*, infrared LED and signal processing circuit, Digital voltage output	-0.3 to +7	-10 to +60	10 to 80	V <sub>CC</sub> -0.3	0.6	MAX. 40	-	24
GP2Y0A41SK0F	Distance measuring sensor united with PSD*, infrared LED and signal processing circuit, Short measuring cycle (16.5 ms)	-0.3 to +7	-10 to +60	4 to 30	V <sub>O</sub> (TYP.) = 0.4 V (at L = 30 cm), ΔV <sub>O</sub> (TYP.) = 2.25 V (at L = 30 cm → 4 cm)		MAX. 22	-	-
GP2D150AJ00F	Distance measuring sensor united with PSD*, infrared LED and signal processing circuit, Digital voltage output	-0.3 to +7	-10 to +60	3 to 30	V <sub>CC</sub> -0.3	0.6	MAX. 50	-	-
GP2D150MJ00F▲	Distance measuring sensor united with PSD*, infrared LED and signal processing circuit, Digital voltage output	-0.3 to +7	-10 to +60	3 to 30	V <sub>CC</sub> -0.3	0.6	MAX. 50	-	17.5
GP2Y0D413K0F	Distance measuring sensor united with PSD*, infrared LED and signal processing circuit, Digital voltage output	-0.3 to +7	-10 to +60	3 to 30	V <sub>CC</sub> -0.3	0.6	-	-	13
GP2Y0D02YK0F	Distance measuring sensor united with PSD*, infrared LED and signal processing circuit, long distance measuring sensor unit (No external control signal required), Digital voltage output according to the measured distance	-0.3 to +7	-10 to +60	20 to 150	V <sub>CC</sub> -0.3	0.6	MAX. 50	-	80

\*1 V<sub>CC</sub> = 5 V

The model marked with ▲ may not be available in the near future. Contact with SHARP for details before use.

\* PSD: Position Sensitive Detector

### Notice

In the absence of confirmation by device specification sheets, SHARP takes no responsibility for any defects that may occur in equipment using any SHARP devices shown in catalogs, data books, etc.

Except where specially indicated, models listed on this page comply with the RoHS Directive\*. For details, please contact SHARP. \*RoHS Directive: Prohibits use of lead, cadmium, hexavalent chromium, mercury and specific brominated flame retardants (PBBs and PBDEs), with certain exceptions.

Contact SHARP in order to obtain the latest device specification sheets before using any SHARP device.

☆New product



## Distance Measuring Sensors (2)

(Ta = 25°C)

Model No.	Features	Absolute maximum ratings		Electro-optical characteristics*1					
		Vcc (V)	Topr (°C)	Distance measuring range (cm)	VoH (V) MIN.	VoL (V) MAX.	Dissipation current		Measured distance (cm)
							Operating (mA)	Standby (µA)	
GP2Y0A02YK0F	Distance measuring sensor united with PSD*, infrared LED and signal processing circuit	-0.3 to +7	-10 to +60	20 to 150	Vo (TYP.) = 0.4 V (at L = 150 cm), ΔVo (TYP.) = 2.0 V (at L = 150 cm → 20 cm)		MAX. 50	-	-
☆GP2Y0A710K0F	Distance measuring sensor united with PSD*, infrared LED and signal processing circuit	-0.3 to +7	-10 to +60	100 to 550	Vo (TYP.) = 2.5 V (at L = 100 cm), ΔVo (TYP.) = 0.7 V (at L = 100 cm → 200 cm)		TYP. 30	-	-

\*1 Vcc = 5 V

\* PSD: Position Sensitive Detector

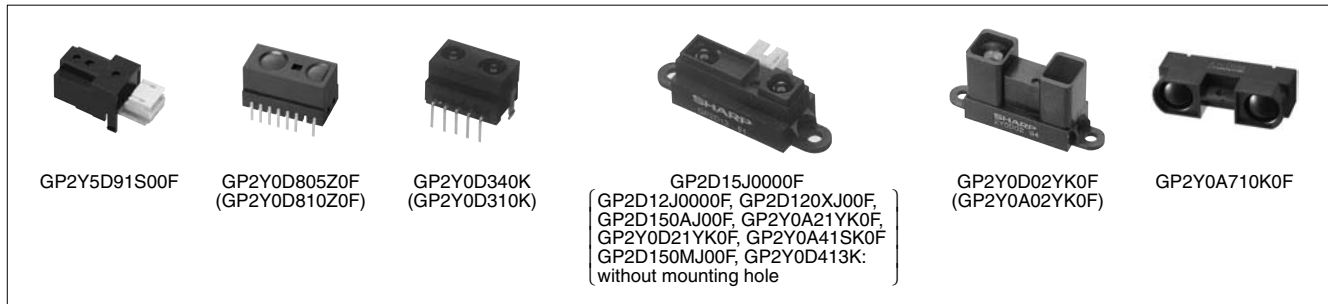

## Wide Angle Sensors

(Ta = 25°C)

Model No.	Features	Absolute maximum ratings		Electro-optical characteristics				
		Vcc (V)	Topr (°C)	Distance measuring range (cm)	Output terminal voltage (V)	Output voltage difference (V)	Input voltage (V)	
							VINH	LEDL
GP2Y3A001K0F	Distance measuring sensor united with PSD*, infrared LED and signal processing circuit,	-0.3 to +7	-10 to +60	4 to 30	TYP. 2.8*1	TYP. 1.6*4	MIN. 4.5	MAX. 0.5
GP2Y3A002K0F	Distance measuring sensor application product,	-0.3 to +7	-10 to +60	20 to 150	TYP. 2.3*2	TYP. 1.6*5	MIN. 4.5	MAX. 0.5
GP2Y3A003K0F	Wide range (field of view) detection using 5 infrared beams	-0.3 to +7	-10 to +60	40 to 300	TYP. 2.2*3	TYP. 1.2*6	MIN. 4.5	MAX. 0.5

\* PSD: Position Sensitive Detector

Reflector used: White paper (Gray chart R-27/white surface, made by Kodak Corp., reflectance 90%)

\*1 L = 4 cm

\*4 Change in output voltage from L = 4 cm to 10 cm

\*2 L = 20 cm

\*5 Change in output voltage from L = 20 cm to 80 cm

\*3 L = 40 cm

\*6 Change in output voltage from L = 40 cm to 100 cm

L = Reflector - Sensor distance



### Notice

In the absence of confirmation by device specification sheets, SHARP takes no responsibility for any defects that may occur in equipment using any SHARP devices shown in catalogs, data books, etc.

Except where specially indicated, models listed on this page comply with the RoHS Directive\*. For details, please contact SHARP. \*RoHS Directive: Prohibits use of lead, cadmium, hexavalent chromium, mercury and specific brominated flame retardants (PBBs and PBDEs), with certain exceptions.

Contact SHARP in order to obtain the latest device specification sheets before using any SHARP device.



## ■ Paper Size Sensors

(Ta = 25°C)

Model No.	Features	Operating temperature	Supply voltage	Paper detection height	LED beam pitch	Approved value of paper position sliding	Paper detection density	Dissipation current
		Topr (°C)	Vcc (V)	H (mm)	Lp (mm)	$\Delta x$ (mm)	OD	Icc (mA)
GP2D03J0000F GP2D032J0000F*4	8-bit serial output using optical distance measuring method (2-beam)	0 to +60	5 ±0.5	TYP. 60	TYP. 21	MAX. ±6	0.7 or less*1	TYP. 30
GP2D06J0000F GP2D061J0000F*2 GP2D062J0000F*2	8-bit serial output using optical distance measuring method (1-beam)	0 to +60	5 ±0.5	TYP. 60	–	MAX. ±6	0.7 or less*1	TYP. 33
GP2Y2E101K0F	Thin type (T: 11 mm) 8-bit serial output using optical distance measuring method (1-beam)	0 to +60	5 ±0.5	TYP. 85	–	MAX. ±6	0.7 or less*1	–
GP2Y2D160K0F	Thin type (T: 11.5 mm) using optical distance measuring method (1-beam) Digital output (1-bit)	–10 to +60	5 ±0.5	TYP. 60	–	MIN. ±7.5	0.7 or less*1	–
GP2D07J0000F GP2D071J0000F*3	8-bit serial output using optical distance measuring method (3-beam)	0 to +60	5 ±0.5	TYP. 60	TYP. 36	MAX. ±6	0.7 or less*1	TYP. 33
GP2Y2E301K0F	Thin type (T: 11 mm) 8-bit serial output using optical distance measuring method (3-beam)	0 to +60	5 ±0.5	TYP. 85	TYP. 33	MAX. ±6	0.7 or less*1	–
GP2Y2A180K0F	Thin type (T: 11.5 mm) Analog output using optical distance measuring method (1-beam)	–10 to +60	5 ±0.5	TYP. 80	–	–	–	MAX. 25
GP2Y2A280K0F	Thin type (T: 11.5 mm) Analog output using optical distance measuring method (2-beam)	–10 to +60	5 ±0.5	TYP. 80	–	–	–	MAX. 50

\* This table shows the characteristics when configured in the paper size sensor system.

\*1 Reflectivity: 18% or more, OD = log (1/T), T: Reflectivity

\*2 Paper detection height GP2D061: TYP. 45 mm GP2D062: TYP. 90 mm

\*3 Paper detection height GP2D071: TYP. 45 mm

\*4 Paper detection height GP2D032: TYP. 45 mm



**Notice**

In the absence of confirmation by device specification sheets, SHARP takes no responsibility for any defects that may occur in equipment using any SHARP devices shown in catalogs, data books, etc. Except where specially indicated, models listed on this page comply with the RoHS Directive\*. For details, please contact SHARP. \*RoHS Directive: Prohibits use of lead, cadmium, hexavalent chromium, mercury and specific brominated flame retardants (PBBs and PBDEs), with certain exceptions. Contact SHARP in order to obtain the latest device specification sheets before using any SHARP device.

☆New product



## High-Precision Displacement Sensor

(Ta = 25°C)

Model No.	Features	Topr (°C)	Operating supply voltage (V)	Dissipation current (mA)	Distance measuring range (mm)	Distance characteristic of output
GP2Y0AH01K0F	Resolution: 50 μm	-10 to +60	4.5 to 5.5	TYP. 20	4.5 to 6.0	TYP. 1.73 V Variation in output over range (4.5 to 6.0 mm)



## Dust Sensor Units

(Ta = 25°C)

Model No.	Features	Topr (°C)	Electro-optical characteristics				
			Operating supply voltage (V)	Dissipation current (mA)	Detection sensitivity V/(0.1 mg/m <sup>3</sup> )	Output voltage at no dust Voc (V)	Output voltage range Voh (V)
GP2U06J0000F▲	Built-in infrared emitting diode, photodiode and signal processing circuit	-10 to +65	4.5 to 5.5	TYP. 15	TYP. 0.5	MAX. 1	MIN. 3.2
GP2Y1010AU0F	Compact, single-shot detection of house dust	-10 to +65	4.5 to 5.5	TYP. 11	TYP. 0.5	TYP. 0.9	MIN. 3.4

The model marked with ▲ may not be available in the near future. Contact with SHARP for details before use.

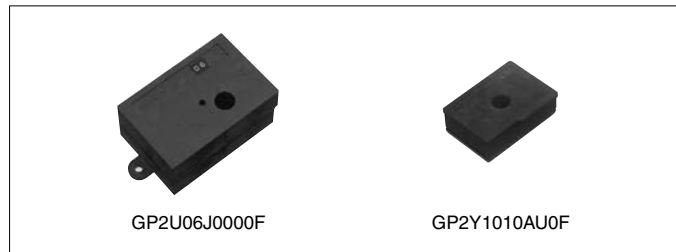

## Color Toner Concentration (Deposition Amount) Sensors

(Ta = 25°C)

Model No.	Features	Topr (°C)	Electro-optical characteristics		
			Dissipation current (mA)	Output voltage V <sub>01</sub> (V)	Output voltage V <sub>02</sub> (V)
GP2TC1J0000F	Employs diffuse reflection system, high-precision detection of toner concentration on photo-sensitive drum, 2-line analog output	0 to +60	TYP. 4*1	TYP. 1.06*2	TYP. 2.63*2
☆GP2Y40010K0F	Employs diffuse reflection system + mirror reflection system, high-precision detection of toner concentration on transfer belt, 2-line analog output	0 to +60	MAX. 10	MAX. 1.61	MAX. 3.5

\*1 Dissipation current with LED drive current of I<sub>F</sub> = 0 mA

\*2 With reflection object A (Reflectance: 15.6%)

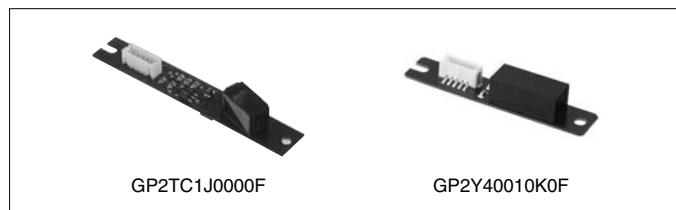

### Notice

In the absence of confirmation by device specification sheets, SHARP takes no responsibility for any defects that may occur in equipment using any SHARP devices shown in catalogs, data books, etc. Except where specially indicated, models listed on this page comply with the RoHS Directive\*. For details, please contact SHARP. \*RoHS Directive: Prohibits use of lead, cadmium, hexavalent chromium, mercury and specific brominated flame retardants (PBBs and PBDEs), with certain exceptions. Contact SHARP in order to obtain the latest device specification sheets before using any SHARP device.



## ■ Fiber Optics Lineup for Audio Equipment

Connector type	Type	Features	Model No.				
			Supply voltage 2.5 V	Supply voltage 3.0 V	Supply voltage 5.0 V		
Square connector (EIAJ RC-5720B)	Fiber optic transmitter	Compact (without mounting hole) High speed signal transmission (13.2 Mb/s MAX., 15.5 Mb/s MAX.*, 50 Mb/s MAX.**), With shutter	–	GP1FM313TZ0F*/ GP1FMV31TK0F*	GP1FM513TZ0F/ GP1FM55HTZ0F**		
	Fiber optic receiver	with mounting hole	High speed signal transmission (13.2 Mb/s MAX. [15.5 Mb/s MAX.*, 25 Mb/s MAX.**], 50 Mb/s MAX.***)	–	GP1FAV30TK0F*	–	
			With shutter	–	TTL drive compatible GP1FAV50TK0F	GP1FAV50TK0F	
		Electric jack integrated type (Transmission speed 13.2 Mb/s)	With shutter	–	–	Vertical mounting type GP1FSV31TK0F	–
						TTL drive compatible	GP1FAV51TK0F
						Vertical mounting type GP1FSV51TK0F	–
		Compact (without mounting hole)	High speed signal transmission (13.2 Mb/s MAX., 15.5 Mb/s MAX.*, With shutter)	–	GP1FMV31RK0F*	GP1FMV51RK0F	
	High speed signal transmission (13.2 Mb/s MAX. [15.5 Mb/s MAX.*, 25 Mb/s MAX.**])		–	GP1FAV30RK0F*	GP1FAV50RK0F		
	Thin type (t: 4.2 mm)	Fiber optic transmitter	Low operating voltage	GP1FD210TP0F	GP1FD310TP0F/ GP1FD320TP0F	–	
			Thin type (t: 4.2 mm)	GP1FD210RP0F	–	–	

## ■ Transmission/Reception Devices for MOST\*1 Compatible Optical Fiber

Connector type	Type	Features	Transmission speed	Operating voltage	Model No.
MOST ver1.1 standard compatible	Optic transmission device	Wide operating temperature range (–40°C to +105°C)	25Mb/s as optic fiber link (Biphase)	5 V	GP5FM5T01AZ
	Optic reception device	Wide operating temperature range (–40°C to +105°C)	25Mb/s as optic fiber link (Biphase)	5 V	GP5FM5R01AZ

\*1 "MOST" is a registered trademark of MOST Cooperation.

## ■ Fiber Optic Transmitters (Square Connector)

(Ta = 25°C)

Model No.	Features	Absolute maximum ratings			Electro-optical characteristics					
		Vcc (V)	Vin (V)	Topr (°C)	Supply voltage (V)	Propagation delay time		Dissipation current Icc (mA) MAX.	Pulse width distortion Δtw (ns)	Transmission speed T (Mb/s) MAX.
						tPLH (ns) MAX.	tPHL (ns) MAX.			
GP1FM313TZ0F	Compact (without mounting hole), With shutter, High response speed (up to x2)	-0.5 to +7	-0.5 to Vcc + 0.5	-20 to +70	2.7 to 3.6	180	180	12	±15	15.5
GP1FMV31TK0F	Compact (without mounting hole), With shutter, High response speed (up to x2)	-0.5 to +7	-0.5 to Vcc + 0.5	-20 to +70	2.7 to 5.25	180	180	12	±15	15.5
GP1FM513TZ0F	Compact (without mounting hole), With shutter, High response speed (up to x2)	-0.5 to +7	-0.5 to Vcc + 0.5	-20 to +70	4.75 to 5.25	180	180	13	±15	13.2
GP1FMV51TK0F	Compact (without mounting hole), With shutter, High response speed (up to x2)	-0.5 to +7	-0.5 to Vcc + 0.5	-20 to +70	4.75 to 5.25	180	180	13	±15	13.2
GP1FM55HTZ0F	Compact (without mounting hole), With shutter, High response speed (up to x2)	-0.5 to +7	-0.5 to Vcc + 0.5	-20 to +70	4.75 to 5.25	180	180	13	±15	50
GP1FAV30TK0F	With mounting hole, Low voltage drive, High response speed (up to x2)	-0.5 to +7	-0.5 to Vcc + 0.5	-20 to +70	2.7 to 5.25	180	180	12	±15	15.5
GP1FAV50TK0F	With mounting hole, Mass-market model, High response speed (up to x2), TTL drive compatible	-0.5 to +7	-0.5 to Vcc + 0.5	-20 to +70	4.75 to 5.25 Input voltage: MIN. 2.0 V	180	180	13	±15	13.2
GP1FAV51TK0F	With mounting hole, Mass-market model, High response speed, With shutter, TTL drive compatible	-0.5 to +7	-0.5 to Vcc + 0.5	-20 to +70	4.75 to 5.25	180	180	13	±15	13.2
☆GP1FSV51TK0F	With mounting hole, Vertical mounting, With shutter, Low voltage drive, High response speed	-0.5 to +7	-0.5 to Vcc + 0.5	-20 to +70	4.75 to 5.25	180	180	13	±15	13.2
GP1FAV31TK0F	With mounting hole, With shutter, Low voltage drive, High response speed	-0.5 to +7	-0.5 to Vcc + 0.5	-20 to +70	2.7 to 5.25	180	180	12	±15	15.5
☆GP1FSV31TK0F	With mounting hole, Vertical mounting, With shutter, Low voltage drive, High response speed	-0.5 to +7	-0.5 to Vcc + 0.5	-20 to +70	2.7 to 5.25	180	180	13	±15	15.5
GP1FAV55TK0F	With mounting hole, High response speed (50 Mb/s), With shutter	-0.5 to +7	-0.5 to Vcc + 0.5	-20 to +70	4.75 to 5.25	180	180	13	±15	50
GP1FP513TK0F	Electric jack/optical connector integrated type	-0.5 to +7	-0.5 to Vcc + 0.5	-20 to +70	4.75 to 5.25	180	180	13	±15	13.2

## ■ Fiber Optic Transmitters (ø3.5 mm Optical Mini-jack)

(Ta = 25°C)

Model No.	Features	Absolute maximum ratings			Electro-optical characteristics					
		Vcc (V)	Vin (V)	Topr (°C)	Supply voltage (V)	Propagation delay time		Dissipation current Icc (mA) MAX.	Pulse width distortion Δtw (ns)	Transmission speed T (Mb/s) MAX.
						tPLH (ns) MAX.	tPHL (ns) MAX.			
GP1FD210TP0F	Compact, Thin type (t: 4.2 mm), Optical mini-jack (low voltage type)	-0.5 to +7	-0.5 to Vcc + 0.5	-20 to +70	2.2 to 3.0	180	180	10	±30	8
GP1FD310TP0F	Compact, Thin type (t: 4.2 mm), Optical mini-jack (low voltage type)	-0.5 to +7	-0.5 to Vcc + 0.5	-20 to +70	2.7 to 3.6	180	180	12	±30	8
GP1FD320TP0F	Compact, Thin type (t: 4.2 mm), Optical mini-jack (low voltage type)	-	-	-20 to +70	2.3 to 5.5	-	-	12	-	25

**Notice**

In the absence of confirmation by device specification sheets, SHARP takes no responsibility for any defects that may occur in equipment using any SHARP devices shown in catalogs, data books, etc.  
 Except where specially indicated, models listed on this page comply with the RoHS Directive\*. For details, please contact SHARP.  
 \*RoHS Directive: Prohibits use of lead, cadmium, hexavalent chromium, mercury and specific brominated flame retardants (PBBs and PBDEs), with certain exceptions.  
 Contact SHARP in order to obtain the latest device specification sheets before using any SHARP device.



## ■ Fiber Optic Receivers (Square Connector)

(Ta = 25°C)

Model No.	Features	Absolute maximum ratings			Electro-optical characteristics					
		Vcc (V)	IOL (mA)	Topr (°C)	Supply voltage (V)	Propagation delay time		Dissipation current Icc (mA) MAX.	Pulse width distortion Δtw (ns)	Transmission speed T (Mb/s) MAX.
						tPLH (ns) MAX.	tPHL (ns) MAX.			
GP1FMV31RK0F	Compact (without mounting hole), With shutter, High response speed (up to x2)	-0.5 to +7	10	-20 to +70	2.7 to 3.6	180	180	15	±20	15.5
GP1FMV51RK0F	Compact (without mounting hole), With shutter, High response speed (up to x2)	-0.5 to +7	10	-20 to +70	4.75 to 5.25	180	180	25	±20	13.2
GP1FAV30RK0F	With mounting hole, Low voltage drive, High response speed	-0.5 to +7	10	-20 to +70	2.7 to 3.6	180	180	15	±20	15.5
GP1FAV50RK0F	With mounting hole, Mass-market model, High response speed (up to x2)	-0.5 to +7	10	-20 to +70	4.75 to 5.25	180	180	25	±20	13.2
GP1FAV51RK0F	High response speed (up to x2), with shutter	-0.5 to +7	10	-20 to +70	4.75 to 5.25	180	180	25	±20	13.2
GP1FAV31RK0F	With mounting hole, With shutter, Low voltage drive, High response speed (up to x2)	-	-	-20 to +70	2.7 to 3.6	-	-	15	-	15.5
GP1FA51HRZ0F	With mounting hole, High response speed (up to x4), with shutter	-	-	-20 to +70	4.75 to 5.25	-	-	15	-	25
GP1FP513RK0F	Electric jack/optical connector integrated type	-0.5 to +7	10	-20 to +70	4.75 to 5.25	180	180	25	±20	13.2

## ■ Fiber Optic Receivers (ø3.5 mm Optical Mini-jack)

(Ta = 25°C)

Model No.	Jack	Features	Absolute maximum ratings			Electro-optical characteristics					
			Vcc (V)	IOL (mA)	Topr (°C)	Supply voltage (V)	Propagation delay time		Dissipation current Icc (mA) MAX.	Pulse width distortion Δtw (ns)	Transmission speed T (Mb/s) MAX.
							tPLH (ns) MAX.	tPHL (ns) MAX.			
GP1FD210RP0F	ø3.5	Thin (thickness: 4.2 mm), optical mini-jack (low voltage drive)	-0.5 to +7	4	-20 to +70	2.4 to 3.0	180	180	7.5	±30	8

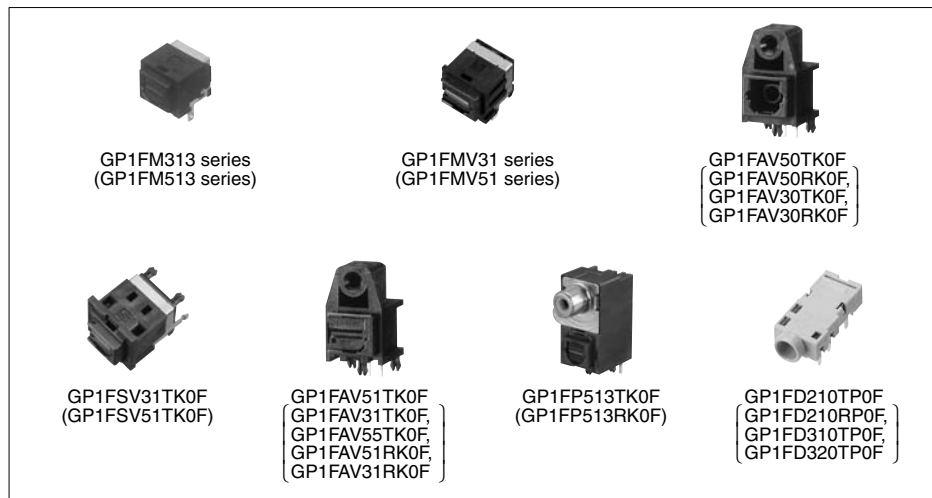

### Notice

In the absence of confirmation by device specification sheets, SHARP takes no responsibility for any defects that may occur in equipment using any SHARP devices shown in catalogs, data books, etc.  
 Except where specially indicated, models listed on this page comply with the RoHS Directive\*. For details, please contact SHARP.  
 \*RoHS Directive: Prohibits use of lead, cadmium, hexavalent chromium, mercury and specific brominated flame retardants (PBBs and PBDEs), with certain exceptions.  
 Contact SHARP in order to obtain the latest device specification sheets before using any SHARP device.



## ■ Optical Transmission Device

Model No.	Features	Operating temperature (°C)	Optic output (dBm)	Operating voltage (V)	Transmission speed T (Mb/s)
GP5FM5T01AZ	<ul style="list-style-type: none"> <li>• MOST standard compatible</li> <li>• Wide operating temperature range</li> </ul>	-40 to +105	-9 to -1.5	4.75 to 5.25	25 (Biphase)

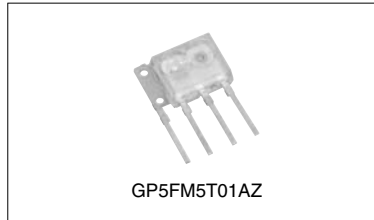

## ■ Optical Reception Device

Model No.	Features	Operating temperature (°C)	Optic output (dBm)	Operating voltage (V)	Transmission speed T (Mb/s)
GP5FM5R01AZ	<ul style="list-style-type: none"> <li>• MOST standard compatible</li> <li>• Wide operating temperature range</li> </ul>	-40 to +105	-24 to -2	4.75 to 5.25	25 (Biphase)

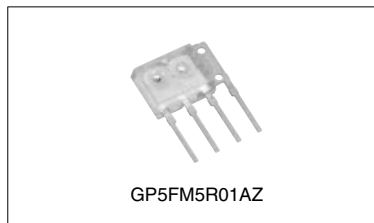

**Notice**

In the absence of confirmation by device specification sheets, SHARP takes no responsibility for any defects that may occur in equipment using any SHARP devices shown in catalogs, data books, etc.  
 Except where specially indicated, models listed on this page comply with the RoHS Directive\*. For details, please contact SHARP.  
 \*RoHS Directive: Prohibits use of lead, cadmium, hexavalent chromium, mercury and specific brominated flame retardants (PBBs and PBDEs), with certain exceptions.  
 Contact SHARP in order to obtain the latest device specification sheets before using any SHARP device.





☆New product



## High-Luminosity LED Lamps

(If = 20 mA, Ta = 25°C)

Appearance	Radiation shape (mm)	Resin type					High-luminosity							
		Colored diffusion	Colored transparency	Colorless transparency	Milky diffusion	BC (Blue)		GC (Green)		TR, T (Red)		UR, U (Red)		
						Model No.	Luminous intensity (mcd) TYP.	Model No.	Luminous intensity (mcd) TYP.	Model No.	Luminous intensity (mcd) TYP.	Model No.	Luminous intensity (mcd) TYP.	
Cylinder	ø3	●								GL3TR8	60	GL3UR8	300	
			●							GL3TR44	110	GL3UR44	250	
				●						GL3TR43	20	GL3UR43	100	
					●	GL3BC302B0S2	900							
					●								GL3UR402B0S	350
	ø5				●	GL3B2402B0SC	650	GL3G2402B0SC	2 800					
		●								GL5TR8	80			
					●							GL5UR44	850	
			●									GL5UR2K	2 000	
				●								GL5UR3K	3 000	
				●					GL5TR43	500	GL5UR2K1	2 000		
				●							GL5UR3K1	3 000		
Oval	Long: 5.8 Short: 4.6		●								GL6UR11T*1	300		
Rectangle	2.0 × 5.0	●									GL6UR31	950		
	1.8 × 3.9	●									GL6UR26T*1	400		
											GL8TR21	16		
											GL8TR42	4		

\*1 With tie-bar

Taped model is also available.

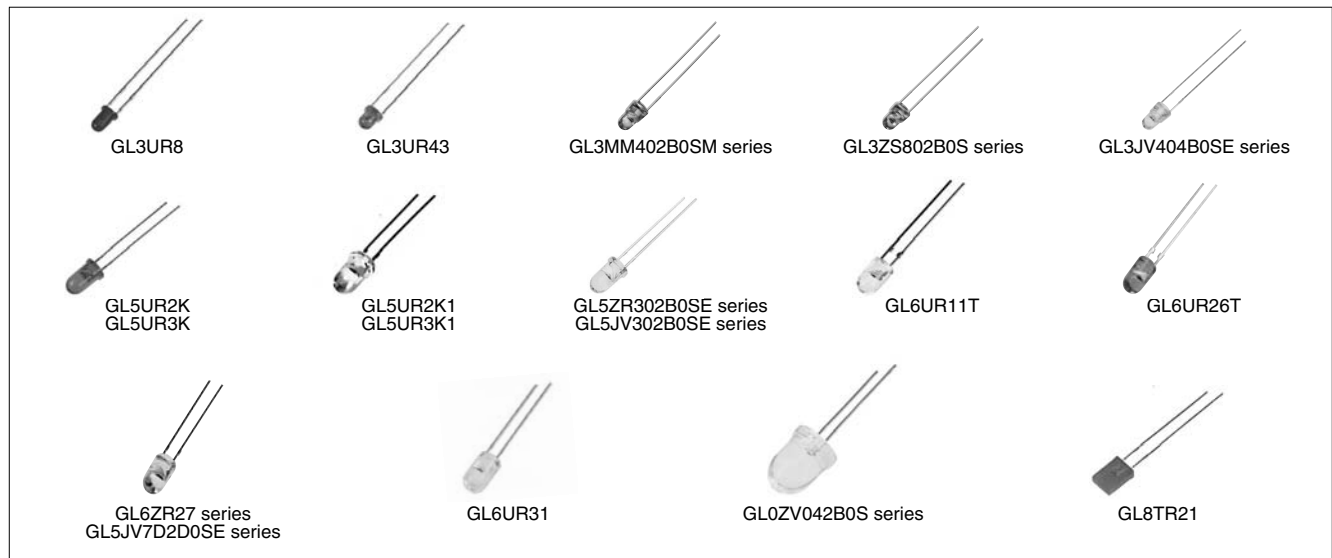

**Notice**

In the absence of confirmation by device specification sheets, SHARP takes no responsibility for any defects that may occur in equipment using any SHARP devices shown in catalogs, data books, etc. Except where specially indicated, models listed on this page comply with the RoHS Directive\*. For details, please contact SHARP. \*RoHS Directive: Prohibits use of lead, cadmium, hexavalent chromium, mercury and specific brominated flame retardants (PBBs and PBDEs), with certain exceptions. Contact SHARP in order to obtain the latest device specification sheets before using any SHARP device.



## LED Lamps

(I<sub>F</sub> = 20 mA\*1, T<sub>a</sub> = 25°C)

Appearance	Radiation shape (mm)	Resin type				KG		EG		FG		HY		HS		HD		PR	
		Colored diffusion	Colored transparency	Colorless transparency	Milky diffusion	Green		Yellow-green		Yellow-green (HL)		Yellow		Sunset orange		Red		Red	
						(555 nm)	Luminous intensity (mcd) TYP.	(565 nm)	Luminous intensity (mcd) TYP.	(565 nm)	Luminous intensity (mcd) TYP.	(585 nm)	Luminous intensity (mcd) TYP.	(610 nm)	Luminous intensity (mcd) TYP.	(635 nm)	Luminous intensity (mcd) TYP.	(695 nm)	Luminous intensity (mcd) TYP.
Cylinder	ø3	●				GL3KG8	30	GL3EG8	60			GL3HY8	55	GL3HS8	60	GL3HD8	40	GL3PR8	8
		●						GL3EG41	130										
			●			GL3KG44	60	GL3EG44	130			GL3HY44	100	GL3HS44	100	GL3HD44	110	GL3PR44	12
			●			GL3KG43	20	GL3EG43	38			GL3HY43	25	GL3HS43	25	GL3HD43	25	GL3PR43	3
			●			GL3KG62	22	GL3EG62	65			GL3HY62	40	GL3HS62	40	GL3HD62	50		
			●			GL3KG63	6	GL3EG63	18			GL3HY63	16	GL3HS63	15	GL3HD63	17	GL3PR63	2
			●					LT3E31W*2	18			LT3H31W*2	15			LT3D31W*2	15	LT3P31W*2	1.5
			●					LT3E65W*2	25			LT3H65W*2	25	LT3S65W*2	25	LT3D65W*2	25	LT3P65W*2	3
	ø4	●				GL4KG8	30	GL4EG8	100			GL4HY8	110	GL4HS8	80	GL4HD8	110	GL4PR8	15
		●						GL5EG4	20							GL5HD4	25	GL5PR4	3
		●				GL5KG8	60	GL5EG8	150			GL5HY8	120	GL5HS8	80	GL5HD8	80	GL5PR8	15
			●			GL5KG41	70	GL5EG41	160			GL5HY41	100	GL5HS41	100	GL5HD41	150	GL5PR41	15
				●		GL5KG44	70	GL5EG44	160			GL5HY44	100	GL5HS44	100	GL5HD44	100	GL5PR44	15
					●			GL5EG261B0SB	150							GL5HD261B0SB	80	GL5PR261B0SB	15
					●			GL5EG40	250			GL5HY40	250	GL5HS40	200	GL5HD40	250	GL5PR40	35
					●	GL5KG43	120	GL5EG43	300	GL5FG43	600	GL5HY43	250	GL5HS43	250	GL5HD43	300		
					●			GL5EG60	23							GL5HD60	8		
					●			GL6EG11T*3	120										
		ø5 (Inverted cone)	●					GL5EG47	15					GL5HS47	6	GL5HD47	8		
		Oval	Long: 5.8 Short: 4.6	●				GL6EG26T*3	140										
Convex	ø2	●				GL2EG6	15			GL2HY6	12			GL2HD6	12	GL2PR6	1.5		
Arch	2.5 × 5.0	●				GL8EG2	30							GL8HD2	30				
	2.0 × 3.1	●				GL8EG4	50							GL8HD4	40				
Rectangle	1.8 × 3.9	●			GL8KG42	1.5	GL8EG42	5			GL8HY42	6		GL8HD42	5	GL8PR42	0.7		
	1.9 × 3.9	●					GL8EG5	28			GL8HY5	25		GL8HD5	22				
	2.0 × 3.2	●			GL8KG25	9	GL8EG25	12			GL8HY25	12	GL8HS25	10	GL8HD25	12	GL8PR25	1.5	
	2.0 × 3.2	●			GL8KG29	5	GL8EG29	12			GL8HY29	10	GL8HS29	7			GL8PR29	3	
	2.0 × 4.5	●					GL8EG23	6			GL8HY23	8			GL8HD23	6			
	2.0 × 5.0	●			GL8KG21	4	GL8EG21	8			GL8HY21	8	GL8HS21	8	GL8HD21	8	GL8PR21	0.7	
		●			GL8KG26	4	GL8EG26	8			GL8HY26	8		GL8HD26	8	GL8PR26	0.7		
Square	5.0 × 5.0	●			GL8KG22	3.5	GL8EG22	6			GL8HY22	5	GL8HS22	5	GL8HD22	8	GL8PR22	1.2	
Triangle	Isosceles triangle	●															GL8PR28	0.9	

\*1 PR series (Red): I<sub>F</sub> = 5 mA (GL8PR25, GL8PR29: I<sub>F</sub> = 10 mA)

\*2 Taped model

\*3 With tie-bar

HL: High-luminosity

Taped model is also available.

### Notice

In the absence of confirmation by device specification sheets, SHARP takes no responsibility for any defects that may occur in equipment using any SHARP devices shown in catalogs, data books, etc.

Except where specially indicated, models listed on this page comply with the RoHS Directive\*. For details, please contact SHARP. \*RoHS Directive: Prohibits use of lead, cadmium, hexavalent chromium, mercury and specific brominated flame retardants (PBBs and PBDEs), with certain exceptions.

Contact SHARP in order to obtain the latest device specification sheets before using any SHARP device.



**Cylinder**



GL3PR8 series



GL3PR44 series



GL3HY43 series



GL3KG62 series



LT3E31W series



GL3PR63 series



LT3E65W series



GL4PR8 series



GL5PR4 series



GL5HS8 series



GL5KG41 series



GL5PR44 series



GL5EG40 series



GL5HY43 series



GL5EG60 series



GL6EG11T



GL5HD47 series

**Oval**



GL6EG26T



GL2HY6



GL8EG2 series



GL8HD4 series

**Convex**

**Arch**

**Rectangle**



GL8KG42 series



GL8KG25 series



GL8HY29 series



GL8HD23 series



GL8HS21 series



GL8HY26 series

**Square**

**Triangle**



GL8HD22 series



GL8PR28

**Notice**

In the absence of confirmation by device specification sheets, SHARP takes no responsibility for any defects that may occur in equipment using any SHARP devices shown in catalogs, data books, etc. Except where specially indicated, models listed on this page comply with the RoHS Directive\*. For details, please contact SHARP. \*RoHS Directive: Prohibits use of lead, cadmium, hexavalent chromium, mercury and specific brominated flame retardants (PBBs and PBDEs), with certain exceptions. Contact SHARP in order to obtain the latest device specification sheets before using any SHARP device.

# DICHROMATIC LED LAMPS



## Dichromatic LED Lamps

(The values in luminous intensity are radiation color order) (I<sub>F</sub> = 20 mA\*1, T<sub>a</sub> = 25°C)

Appearance	Radiation shape (mm)	Resin type				E J J		C U *		E P		E D		E H		H P	
		Colored diffusion	Colored transparency	Colorless transparency	Milky diffusion	Yellow-green + Orange (HL)	Luminous intensity (mcd) TYP.	Yellow-green + Red (HL)	Luminous intensity (mcd) TYP.	Yellow-green + Red	Luminous intensity (mcd) TYP.	Yellow-green + Red	Luminous intensity (mcd) TYP.	Yellow-green + Yellow	Luminous intensity (mcd) TYP.	Yellow + Red	Luminous intensity (mcd) TYP.
Cylinder	ø3				●							GL3ED8	20/15				
	ø5				●	GL5EJJ502C0X*2	110/170			GL5EP5	40/9	GL5ED5	40/25			GL5HP5	15/9
				●				GL5CU44	100/240			GL5ED44	80/50				
				●				GL6CU7	120/250			GL5ED60	11/8				
Rectangle	1.9 × 3.9				●							GL8ED5	10/6.5			GL8HP5	3/1.5
	2.0 × 5.0				●							GL9ED2	8/3	GL9EH2	6/2	GL9HP2	1/0.8
	5.0 × 5.0				●							GL9ED4	7/4				

\* CU series: Common anode pin connection

\*1 P (Red) and H (yellow): I<sub>F</sub> = 10 mA

\*2 Taped model

HL: High-luminosity

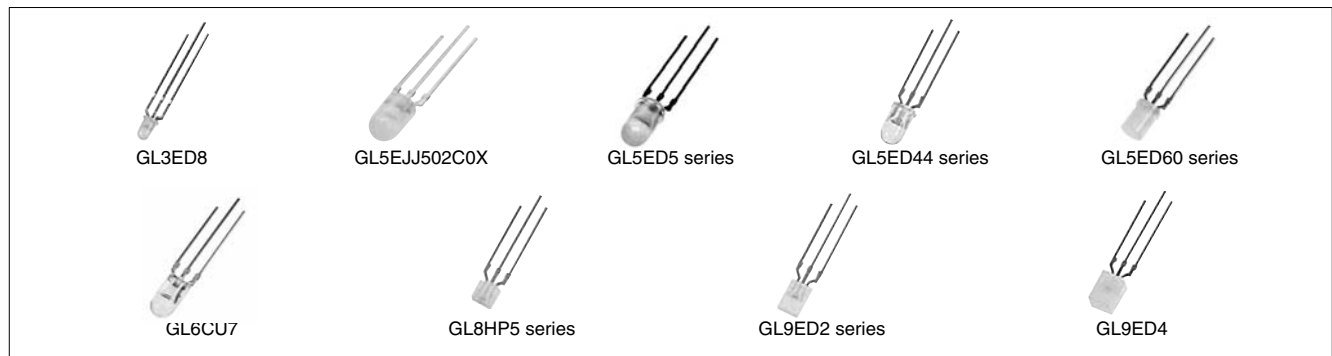

### Notice

In the absence of confirmation by device specification sheets, SHARP takes no responsibility for any defects that may occur in equipment using any SHARP devices shown in catalogs, data books, etc.  
 Except where specially indicated, models listed on this page comply with the RoHS Directive\*. For details, please contact SHARP.  
 \*RoHS Directive: Prohibits use of lead, cadmium, hexavalent chromium, mercury and specific brominated flame retardants (PBBs and PBDEs), with certain exceptions.  
 Contact SHARP in order to obtain the latest device specification sheets before using any SHARP device.

☆New product  
★Under development



## High-Luminosity (AlGaInP) Chip LEDs (Taped Models Only)

(I<sub>F</sub> = 20 mA, T<sub>a</sub> = 25°C\*3)

Outline dimensions (mm)	Resin type				JESE		ZVJV		ZSJS		ZJJJ		ZRJR	
	Colored diffusion	Colored transparency	Colorless transparency	Milky diffusion	Yellow-green	Luminous intensity (mcd) TYP.	Amber	Luminous intensity (mcd) TYP.	Sunset orange	Luminous intensity (mcd) TYP.	Orange	Luminous intensity (mcd) TYP.	Red	Luminous intensity (mcd) TYP.
1.6 × 0.8 (T: 0.35)			●		GM1JE35200AE*1	13	GM1JV35200AE*1	18.8	GM1JS35200AE*1	19	GM1JJ35200AE*1	19	GM1JR35200AE*1	13
1.6 × 0.8 (T: 0.55)			●		GM1JE55200AE*1	13	GM1JV55200AE*1	16.8	GM1JS55200AE*1	20.9	GM1JJ55200AE*1	19		
1.6 × 0.8 (T: 0.8)			●				GM1ZV80300AE	75	GM1ZS80300AE	75	GM1ZJ80300AE	75	GM1ZR80300AE	55
			●				LT1JV67A*1	16.5	LT1JS67A*1	14.1				
2.0 × 1.25 (T: 0.8)			●				GM1ZV40300AE	60	GM1ZS40300AE	78	GM1ZJ40300AE	60	GM1ZR40300AE	55
			●				GM1JV40300AE	11	GM1JS40300AE	12	GM1JJ40300AE	9.5		
3.2 × 2.8 (T: 1.9)			●				★GM5ZV96270A	600					★GM5ZR96270A	600
			●				☆GM5ZV96260AE	320					☆GM5ZR96260AE	300
6.0 × 5.0 (T: 2.5)			●				GM5ZV01200A*2	500	GM5ZS01200A*2	700	GM5ZJ01200A*2	500	GM5ZR01200A*2	400
			●		GM5SE01200A*2	400					GM5SJ01250AL	1 050		
6.0 × 5.0 (T: 2.3) (board insertion type)			●				GM5ZV03200Z*2	500	GM5ZS03200Z*2	700	GM5ZJ03200Z*2	500	GM5ZR03200Z*2	400
2.8 × 1.2 (T: 0.8) (Side emitting)			●				☆GM4ZV83200AE	(100)	☆GM4ZS83200AE	(150)	☆GM4ZJ83200AE	(150)	GM4ZR83200AE	(90)
5.0 × 5.0 (T: 1.5)			●										GM5ZR05240A	3 000

\*1 LT1JS67A, LT1JV67A, GM1JV55200AE series, GM1JV35200AE series, GM1JV40300AE series: I<sub>F</sub> = 5 mA

\*2 GM5ZR01200A series, GM5ZR03200Z series: I<sub>F</sub> = 60 mA

\*3 GM5ZV96260AE series, GM5ZV96270A series, GM5ZV01200A series, GM5ZV03200Z series: T<sub>c</sub> = 25°C

## High-Luminosity (InGaN) Chip LEDs (Taped Models Only)

(I<sub>F</sub> = 10 mA, T<sub>a</sub> = 25°C\*5)

Outline dimensions (mm)	Resin type				BC		GC	
	Colored diffusion	Colored transparency	Colorless transparency	Milky diffusion	Blue	Luminous intensity (mcd) TYP.	Green	Luminous intensity (mcd) TYP.
1.6 × 0.8 (T: 0.35)				●	GM1BC35370AC*1	23		
1.6 × 0.8 (T: 0.55)			●		☆GM1BC55255AC*1	23	☆GM1GC55310AC*4	100
3.2 × 2.8 (T: 1.9)			●		★GM5BC96270A*2	500	★GM5GC96270A	1 300
			●		☆GM5BC96260AC*2	300	☆GM5GC96260AC*2	700
6.0 × 5.0 (T: 2.5)			●		☆GM5BC01250AC*3	400	☆GM5GC01250AC*3	1 200
6.0 × 5.0 (T: 2.3) (board insertion type)			●		☆GM5BC03210Z*3	400	☆GM5GC03210Z*3	1 200
2.8 × 1.2 (T: 0.8) (Side emitting)			●		★GM4BC83200AC*2	(150)	★GM4GC83200AC*2	(300)
5.0 × 5.0 (T: 1.5)			●		★GM5BC05240AC*2	2 000	★GM5GC05240AC*2	4 000

\*1 GM1BC35370AC, GM1BC55255AC: I<sub>F</sub> = 5 mA

\*2 GM5BC96260AC series, GM5BC96270A series, GM4BC83200AC series, GM5BC05240AC series: I<sub>F</sub> = 20 mA

\*3 GM5BC01250AC series, GM5BC03210Z series: I<sub>F</sub> = 50 mA

\*4 GM1GC55310AC: I<sub>F</sub> = 10 mA

\*5 GM5BC96260AC series, GM5BC96270A series, GM5BC01250AC series, GM5BC03210Z series: T<sub>c</sub> = 25°C

### Notice

In the absence of confirmation by device specification sheets, SHARP takes no responsibility for any defects that may occur in equipment using any SHARP devices shown in catalogs, data books, etc.

Except where specially indicated, models listed on this page comply with the RoHS Directive\*. For details, please contact SHARP.  
\*RoHS Directive: Prohibits use of lead, cadmium, hexavalent chromium, mercury and specific brominated flame retardants (PBBs and PBDEs), with certain exceptions.

Contact SHARP in order to obtain the latest device specification sheets before using any SHARP device.



## Chip LEDs (Taped Models Only)

(If = 20 mA\*, Ta = 25°C)

Outline dimensions (mm)	Resin type				Green	Luminous intensity (mcd) TYP.	E F E G		Yellow-green	Luminous intensity (mcd) TYP.	H H Y		Yellow	Luminous intensity (mcd) TYP.
	Colored diffusion	Colored transparency	Colorless transparency	Milky diffusion										
1.6 × 0.8 (T: 0.35)			●					GM1EG35200A	19					
1.6 × 0.8 (T: 0.55)			●					GM1EG55200A	19		GM1HY55200A	11.5		
1.6 × 0.8 (T: 0.8)				●	LT1K67A	3.8		LT1E67A LT1F67A LT1F67AF	23		LT1H67A	8.3		
2.0 × 1.25 (T: 0.8)				●	LT1K40A	5		LT1E40A	19		LT1H40A	10.8		
3.2 × 2.8 (T: 1.9)			●					GM5EG95200A	18.1					

Outline dimensions (mm)	Resin type				S H S		D H D		U U R		P	
	Colored diffusion	Colored transparency	Colorless transparency	Milky diffusion	Sunset orange	Luminous intensity (mcd) TYP.	Red	Luminous intensity (mcd) TYP.	Red (HL)	Luminous intensity (mcd) TYP.	Red	Luminous intensity (mcd) TYP.
1.6 × 0.8 (T: 0.55)			●		GM1HS55200A	11.4	GM1HD55200A	12.5	GM1UR55200A	29.7		
1.6 × 0.8 (T: 0.8)				●	LT1S67A	6.9	LT1D67A	8.8	LT1U67A	29.7	LT1P67A	1.3
2.0 × 1.25 (T: 0.8)				●	LT1S40A	9.4	LT1D40A	11.9	LT1U40A	35.6	LT1P40A	1.3
3.2 × 2.8 (T: 1.9)			●				GM5HD95200A	13.8	GM5UR95200A	80		

\*1 P (Red) series: If = 5 mA

HL: High-luminosity



LT1D67A series  
LT1JS67A series  
GM1ZV80300AE series



GM1EG55200A series  
GM1JV55200AE series  
GM1BC55255AC series



LT1E40A series  
GM1JV40300AE series  
GM1ZV40300AE series



GM1JV35200AE series  
GM1EG35200A  
GM1BC35370AC



GM4ZV83200AE series  
GM4BC83200AC series



GM5ZR05240A  
GM5BC05240AC series



GM5EG95200A series  
GM5ZV96260AE series, GM5BC96260AC series  
GM5BC96270A series



GM5ZR01200A series  
GM5BC01250AC series



GM5ZV03200Z series  
GM5BC03210Z series



Taped model

## High-Luminosity Dichromatic Type Chip LEDs (Taped Models Only)

(If = 40 mA, Tc = 25°C)

Outline dimensions (mm)	Resin type				B C G C		B C Z R		G C Z R	
	Colored diffusion	Colored transparency	Colorless transparency	Milky diffusion	Blue + Green	Luminous intensity (mcd) TYP.	Blue + Red	Luminous intensity (mcd) TYP.	Green + Red	Luminous intensity (mcd) TYP.
6.0 × 5.0 (T: 2.5)			●		GM5BG01210A	300/860	GM5ZR01210A	300/580	GM5ZRG01210A	860/580

### Notice

In the absence of confirmation by device specification sheets, SHARP takes no responsibility for any defects that may occur in equipment using any SHARP devices shown in catalogs, data books, etc. Except where specially indicated, models listed on this page comply with the RoHS Directive\*. For details, please contact SHARP. \*RoHS Directive: Prohibits use of lead, cadmium, hexavalent chromium, mercury and specific brominated flame retardants (PBBs and PBDEs), with certain exceptions. Contact SHARP in order to obtain the latest device specification sheets before using any SHARP device.

☆New product  
★Under development



## ■ Dichromatic Type Chip LEDs (Taped Models Only)

(I<sub>F</sub> = 20 mA, T<sub>a</sub> = 25°C)

Outline dimensions (mm)	Resin type					EH Yellow-green + Yellow		ED Yellow-green + Red		KS Green + Sunset orange	
	Colored diffusion	Colored transparency	Colorless transparency	Milky diffusion		Luminous intensity (mcd) TYP.	Luminous intensity (mcd) TYP.	Luminous intensity (mcd) TYP.	Luminous intensity (mcd) TYP.		
1.6 × 1.6 (T: 0.8)				●	LT1EH67A	19/8.3	LT1ED67A	19/8.3	LT1KS67A	3.8/6.9	



## ■ High-Luminosity White Type Chip LEDs (Taped Models Only)

(T<sub>a</sub> = 25°C\*4)

Outline dimensions (mm)	Color coordinates (x, y)	Radiation color	BW White	
				Luminous intensity (mcd) TYP.
2.8 × 1.2 (T: 0.8) Side view type	(0.30, 0.29)	White	GM4BW83380A*1	1 700
			☆GM4BW83390A*1	1 900
3.85 × 1.2 (T: 0.6) Side view type	(0.30, 0.29)	White	GM4BW63360A*1	1 550
			☆GM4BW63370A*1	1 800
3.85 × 1.0 (T: 0.5) Side view type	(0.30, 0.29)	White	★GM5BW53340A*1	1 800
3.2 × 2.8 (T: 1.9)	(0.31, 0.31)	White	☆GM5BW96320A*1	1 400
			★GM5BW96370A*1	2 000
3.2 × 2.8 (T: 1.4)	(0.31, 0.31)	White	☆GM5BW94320A*1	3 800
5.0 × 5.0 (T: 1.5)	(0.31, 0.31)	White	GM5BW05340A*1	10 000
5.0 × 5.0 (T: 1.6)	(0.31, 0.31)	White	★GM5BW05343A*2	20 000
6.0 × 5.0 (T: 1.5) 6-terminal leadless	(0.31, 0.31)	White	GM5BW01300A*2	4 200
6.0 × 5.0 (T: 2.5) 4-terminal leadless	(0.31, 0.31)	White	GM5BW01301A*3	1 800
			★GM5BW01311A*3	3 300

\*1 GM5BW83380 series, GM4BW63360A series, GM4BW53340A, GM5BW96320A, GM5BW96370A, GM5BW94320A, GM5BW05340A: I<sub>F</sub> = 20 mA

\*2 GM5BW05343A, GM5BW01300A: I<sub>F</sub> = 35 mA/chip

\*3 GM5BW01301A series: I<sub>F</sub> = 40 mA

\*4 GM5BW96320A, GM5BW96370A, GM5BW01300A, GM5BW01301A series: T<sub>c</sub> = 25°C

## ■ Pastel Color Chip LEDs (Taped Models Only)

(I<sub>F</sub> = 20 mA, T<sub>c</sub> = 25°C)

Outline dimensions (mm)		CA Light blue		CY Lemon yellow		CV Purple			
		Color coordinates (x, y)	Luminous intensity (mcd) TYP.	Color coordinates (x, y)	Luminous intensity (mcd) TYP.	Color coordinates (x, y)	Luminous intensity (mcd) TYP.		
3.2 × 2.8 (T: 0.9)	☆GM5CA96320A	(0.17, 0.20)	1 000	★GM5CY96320A	(0.42, 0.48)	1 500	★GM5CV96320A	(0.35, 0.15)	500

### Notice

In the absence of confirmation by device specification sheets, SHARP takes no responsibility for any defects that may occur in equipment using any SHARP devices shown in catalogs, data books, etc.  
Except where specially indicated, models listed on this page comply with the RoHS Directive\*. For details, please contact SHARP.  
\*RoHS Directive: Prohibits use of lead, cadmium, hexavalent chromium, mercury and specific brominated flame retardants (PBBs and PBDEs), with certain exceptions.  
Contact SHARP in order to obtain the latest device specification sheets before using any SHARP device.



# CHIP LEDs / LEDs FOR CAMERA DATA BACK

☆New product  
★Under development



## High-Luminosity Dichromatic Type Chip LEDs (RGB 3-color) (Taped Models Only)

(Ta = 25°C\*11)

Outline dimensions (mm)	Resin type				Luminous intensity (mcd) TYP.
	Colored diffusion	Colored transparency	Colorless transparency	Milky diffusion	
1.6 × 1.6 (T: 0.55)				●	GM1WA55311A*5 20/70/23
2.7 × 1.35 (T: 1.0) Side view type				●	☆GM4WA10200A*5 10 to 40/16 to 100/10 to 42
3.2 × 2.8 (T: 1.4)			●		☆GM5WA94200A*7 (920) [Mixed color]
5.0 × 2.5 (T: 2.5)				●	★GM4WA25300A*8 (2 000) [Mixed color]
6.0 × 5.0 (T: 2.5) 6-terminal leadless			●		GM5WA06250A*2 1 400 [Mixed color]
			●		GM5WA06260A*1 1 725 [Mixed color]
			●		GM5WA06256A*6 1 500 [Mixed color]
			●		GM5WA06270A*3, 4 3 000 [Mixed color]
6.0 × 5.0 (T: 2.3 [resin part]) 6-terminal			●		GM5WA06250Z*2 1 400 [Mixed color]
			●		GM5WA06256Z*6 1 500 [Mixed color]

- \*1 GM5WA06260A: If = 40 mA (Red, Green), If = 20 mA (Blue)  
 \*2 GM5WA06250A, GM5WA06250Z: If = 35 mA (Red, Green), If = 20 mA (Blue)  
 \*3 GM5WA06270A: If = 35 mA (Red, Green, Blue)  
 \*4 GM5WA06270A: T: 2.4 mm  
 \*5 GM1WA55311A/GM4WA10200A: If = 5 mA (Red, Green, Blue)  
 \*6 GM5WA06256A: If = 22 mA (Red), If = 35 mA (Green), If = 13 mA (Blue)  
 \*7 GM5WA94200A: If = 17 mA (Red), If = 20 mA (Green), If = 10 mA (Blue)  
 \*8 GM4WA25300A: If = 21 mA (Red), If = 25 mA (Green), If = 7 mA (Blue)  
 \*9 GM5WA94200A, GM4WA10200A, GM4WA25300A, GM5WA06250A series: Tc = 25°C



## LEDs for Camera Data Back

(If = 1 mA, Ta = 25°C)

Model No.	No. of dots	Outline dimensions (mm)	Radiation color	Luminous intensity (mcd)
GW01M59001PE	7	2.6 × 2.9 (T: 0.9) Surface-mount type	Amber	(MIN. 0.4 TYP. 0.8)

( ) indicates reference value.



### Notice

In the absence of confirmation by device specification sheets, SHARP takes no responsibility for any defects that may occur in equipment using any SHARP devices shown in catalogs, data books, etc.  
 Except where specially indicated, models listed on this page comply with the RoHS Directive\*. For details, please contact SHARP.  
 \*RoHS Directive: Prohibits use of lead, cadmium, hexavalent chromium, mercury and specific brominated flame retardants (PBBs and PBDEs), with certain exceptions.  
 Contact SHARP in order to obtain the latest device specification sheets before using any SHARP device.

## ■ Laser Diodes

### ◆ Model Configurations

Wavelength (nm)	Optical power output (Pulse) (mW) MAX.	Package			
		ø5.6 mm Metal type	ø3.3 mm Metal type	1.8 mm t Resin type	ø5.6 mm Resin type
405 band	20*1	☆GH04020A2GE			
650 band	240	GH06P24A2C		GH16P24A8C	
	300			☆GH16P30A8C	
	350			☆GH16P35A8C	
780 band	5*1	GH07805C2K			GH17805B2AS
	25*1	GH07825C2K			
	240	GH07P24C1C	GH07P24C4C	GH17P24C8C	
	280	GH07P28A1C	GH07P28A4C	☆GH17P28A8C	

\*1 Optical power output (CW) MAX. (mW)

### ◆ Specifications

(Tc = 25°C)

Model No.	Wave-length (nm)	Optical power output (mW) MAX.		Features	Applications	Terminal connections
		CW	Pulse			
GH04020A2GE	405 band	20	—	ø5.6 mm CAN package, operating temperature: 70°C MAX.	Next generation DVD playback	E
GH06P24A2C	650 band	100	240	ø5.6 mm CAN package, operating temperature: 75°C MAX. (pulse drive)	Double-layer DVD x4 writing	B
GH16P24A8C		100	240	1.8 mm frame package, operating temperature: 75°C MAX. (pulse drive)	Double-layer DVD x4 writing	C
GH16P30A8C		120	300	1.8 mm frame package, operating temperature: 75°C MAX. (pulse drive)	Double-layer DVD x8 writing	
GH16P35A8C		125	350	1.8 mm frame package, operating temperature: 75°C MAX. (pulse drive)	Double-layer DVD x16 writing	
GH17805B2AS	780 band	5	—	ø5.6 mm frame package, operating temperature: 70°C MAX., with built-in monitor PD	CD-ROM, CD-Audio	A
GH07805C2K		5	—	ø5.6 mm CAN package, operating temperature: 60°C MAX., with built-in monitor PD	Printer, copier, complex machine	D
GH07825C2K		25	—	ø5.6 mm CAN package, operating temperature: 60°C MAX., with built-in monitor PD	Printer, copier, complex machine	
GH07P24C1C		120	240	ø5.6 mm CAN package, operating temperature: 75°C MAX. (pulse drive)	CD-R/RW (MAX. x48 to x52 writing)	B
GH07P28A1C		150	280	ø5.6 mm CAN package, operating temperature: 75°C MAX. (pulse drive)	CD-R/RW (MAX. x48 to x52 writing)	
GH07P24C4C		120	240	ø3.3 mm CAN package, operating temperature: 75°C MAX. (pulse drive)	CD-R/RW (H/H, slim dual-purpose) (MAX. x48 to x52 writing)	
GH07P28A4C		150	280	ø3.3 mm CAN package, operating temperature: 75°C MAX. (pulse drive)	CD-R/RW (H/H, slim dual-purpose) (MAX. x48 to x52 writing)	
GH17P24C8C		120	240	1.8 mm frame package, operating temperature: 75°C MAX. (pulse drive)	CD-R/RW (H/H, slim dual-purpose) (MAX. x48 to x52 writing)	C
GH17P28A8C		150	280	1.8 mm frame package, operating temperature: 75°C MAX. (pulse drive)	CD-R/RW (H/H, slim dual-purpose) (MAX. x48 to x52 writing)	

### • Terminal Connections

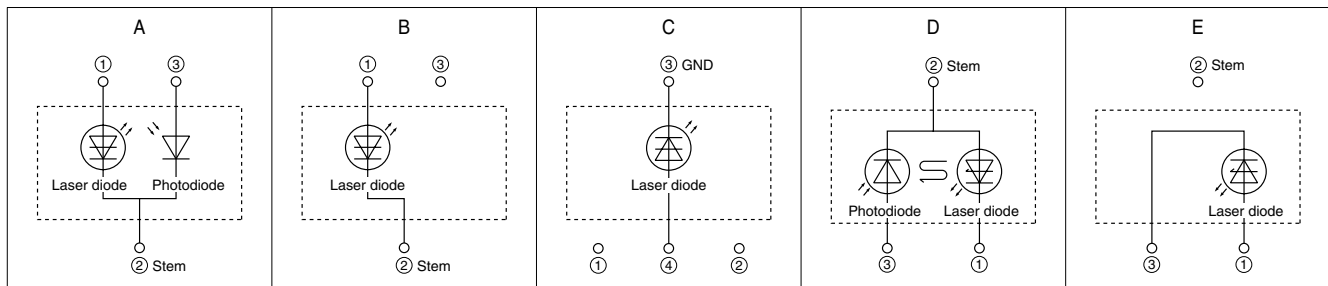

#### Notice

In the absence of confirmation by device specification sheets, SHARP takes no responsibility for any defects that may occur in equipment using any SHARP devices shown in catalogs, data books, etc.  
 Except where specially indicated, models listed on this page comply with the RoHS Directive\*. For details, please contact SHARP.  
 \*RoHS Directive: Prohibits use of lead, cadmium, hexavalent chromium, mercury and specific brominated flame retardants (PBBs and PBDEs), with certain exceptions.  
 Contact SHARP in order to obtain the latest device specification sheets before using any SHARP device.

## ■ Europe: LNB for Broadcasting Satellite

### ◆ Features

- (1) Wide band type receiving all broadcasting channels (analog & digital) of Europe. [Universal LNB]
- (2) Originally developed feed-horn waveguide makes the wide-band, low-noise characteristics possible.
- (3) One of the industry's most compact and lightweight package
- (4) Low consumption current design for energy saving [80 mA (TYP.): BS1R8EL100A]

### ◆ Specifications

Destination	Europe, Astra/Eutelsat Satellite etc.			
Receiving polarization	Horizontal/Vertical polarization			
Model No. <Type>	BS1R8EL500A <4 output>	BS1R8EL400A <4 output>	BS1R8EL200A <2 output>	BS1R8EL100A <1 output>
Input frequency (GHz)	10.7 to 11.7 [Low band], 11.7 to 12.75 [High band]			
Output frequency (MHz)	950 to 1 950 [Low band], 1 100 to 2 150 [High band]			
Local oscillation frequency (GHz)	9.75 [Low band], 10.6 [High band]			
NF (dB)	0.7 (TYP.)			
Conversion gain (dB)	56 (TYP.)			
Phase noise	-55 dBc/Hz @1 kHz (TYP.)			
Cross-polar discrimination (dB)	25 (TYP.)			
Supply voltage (V DC) (Polarization switching voltage)	Vertical polarization	11.5 to 14.0 (0/22 kHz)		
	Horizontal polarization	16.0 to 19.0 (0/22 kHz)		
Power consumption (mA)	210 (TYP.)/250 (MAX.)	310 (TYP.)/350 (MAX.)	190 (TYP.)/250 (MAX.)	80 (TYP.)/120 (MAX.)
Waveguide	Feed-horn (F/D = 0.6)			
Output impedance ( $\Omega$ )	75			
Output connector (F-type)	4-output (H/H, H/L, V/H, V/L)	4-output (H/V, High and low switching)	2-output (H/V, High and low switching)	1-output (H/V, High and low switching)
Outline dimensions (mm)	133.0 × 103.6 × 60.0	133.0 × 103.6 × 60.0	123.5 × 97.0 × 60.0	107.3 × 60.0 × 60.0
Weight (g)	Approx. 255	Approx. 256	Approx. 215	Approx. 110



## ■ U.S.A.: LNB for FSS Broadcast/(Others: LNB for Communication)

### ◆ Specifications

Receiving system	U.S.A.: FSS, Japan and others: for communication
Receiving polarization	Horizontal/vertical polarization
Model No.	BS1C1UR100A
Input frequency (GHz)	11.7 to 12.2
Output frequency (MHz)	950 to 1 450
Local oscillation frequency (GHz)	10.75
NF (dB)	0.7 (TYP.)/0.9 (MAX.)
Conversion gain (dB)	50 to 62
Phase noise	-60 dBc/Hz @1 kHz (TYP.)
Cross-polar discrimination (dB)	—
Supply voltage (V DC)	12 to 24
Power consumption (mA)	120 (TYP.)/150 (MAX.)
Waveguide	WR-75
Output impedance ( $\Omega$ )	75
Output connector (F-type)	1-output
Outline dimensions (mm)	48.6 × 96.3 × 45.5
Weight (g)	Approx. 100



#### Notice

In the absence of confirmation by device specification sheets, SHARP takes no responsibility for any defects that may occur in equipment using any SHARP devices shown in catalogs, data books, etc. Contact SHARP in order to obtain the latest device specification sheets before using any SHARP device.

## Japan/Asia/Australia: LNBs for CS Digital Satellite Broadcast

### ◆ Specifications

Destination	Japan, Asia, Australia, CS Satellite	
Receiving polarization	Horizontal/Vertical polarization	
Model No. <Type>	BS1R8AR100A	
Input frequency (GHz)	11.70 to 12.75	
Output frequency (MHz)	1 000 to 2 050	
Local oscillation frequency (GHz)	10.7	
NF (dB)	0.7 (TYP.) / 0.9 (MAX.)	
Conversion gain (dB)	55 to 64	
Phase noise	-75 dBc/Hz @ 1 kHz (TYP.)	
Cross-polar discrimination (dB)	25 (TYP.)	
Supply voltage (V DC) (Polarization switching voltage)	Vertical polarization	11.5 to 14.0
	Horizontal polarization	16.0 to 19.0
Power consumption (mA)	80 (TYP.)/120 (MAX.)	
Waveguide	Feed-horn (F/D = 0.6)	
Output impedance ( $\Omega$ )	75	
Output connector (F-type)	1-output (H/V switching)	
Outline dimensions (mm)	107.3 × 60 × 60	
Weight (g)	Approx. 110	



BS1R8AR100A

## Japan: LNBs for BS/CS 110° Satellite Broadcast

### ◆ Features

- (1) Can receive 2 satellite broadcasts of 110° BS/CS digital  
[Employs wide-band (1 GHz) circular' linear polarization conversion technology (septum waveguide structure)]
- (2) Outstanding noise figure (NF) characteristics enabling compact design of antenna diameter. [NF: 0.45 dB (TYP.)/BS1F6JU300A]
- (3) Low current consumption design for improved energy saving. [80 mA (TYP.)]

### ◆ Standard Specifications

Destination	Japan BS/CS 110° Satellite		
Receiving polarization	Right circular polarization		Right/Left circular polarization
Model No.	BS1F6JU300A	BS1F6JP300A	BS1F6JP100A
Input frequency (GHz)	11.71023 to 12.751		
Output frequency (MHz)	1 032.23 to 2 073		
Local oscillation frequency (GHz)	10.678		
NF (dB)	0.45 (TYP.) / 0.6 (MAX.)	0.7 (TYP.) / 1.1 (MAX.)	
Conversion gain (dB)	48 to 60		
Phase noise	-65 dBc/Hz @ 1 kHz (TYP.)		
Cross-polar discrimination (dB)	25 (TYP.)/20 (MIN.)		
Supply voltage (V DC) (Polarization switching voltage)	Right circular polarization	9.5 to 18.0	13.5 to 16.5
	Left circular polarization	—	9.5 to 12.0
Power consumption (mA)	80 (TYP.)/110 (MAX.)		
Waveguide	Feed-horn (F/D=0.5)		
Output impedance ( $\Omega$ )	75		
Output connector (F-type)	1-output	1-output (R/L switching)	
Outline dimensions (mm)	96 × 53.07 × 71		
Weight (g)	Approx. 130 (not including outer cabinet)		



BS1F6JP300A

\* Outer cabinet is made upon request.

#### Notice

In the absence of confirmation by device specification sheets, SHARP takes no responsibility for any defects that may occur in equipment using any SHARP devices shown in catalogs, data books, etc. Contact SHARP in order to obtain the latest device specification sheets before using any SHARP device.

## ■ Digital DBS Front-End Units

**D**BS front-end unit for digital broadcasting features high quality of signal transmission and improved elimination ability of various kinds of rejection thanks to using Sharp's original ICs.

### ◆ Features

- (1) Equipped with a direct conversion IC developed by Sharp. Reliability is improved by reducing power consumption and component counts.
- (2) Wide-band reception design also covering CS broadcast band. [Reception frequency: 950 to 2 150 MHz]
- (3) Wide product line-up of LINK integrated types for contributing to set development time reduction.  
[Compatible with DVB-S/DVB-S2/ISDB-S demodulation]
- (4) User support tools can be provided. [Sample/evaluation boards and software are available.]

### ◆ Standard Specifications <I/Q output type>

Destination		Global	
Demodulator system		DVB-S	ISDB-S/DVB-S2
Input type		1-input/1-loop through output	1-input
Model No.		BS2S7HZ0502	BS2S7HZ6306
Input frequency (MHz)		950 to 2 150	
Input signal level (dBm)		-65 to -25	
The 1st intermediate frequency (MHz)		Zero-IF (Direct conversion)	
Base band frequency bandwidth		10 to 30, 2.0 MHz step (BB LPF)	
RF input local leak (dBm)		-70 and below	
PLL phase noise (dBc/Hz)	10 kHz offset	-80 (TYP.)	-85 (TYP.)
	1 kHz offset	-75 (TYP.)	-80 (TYP.)
Output type		I/Q	
Channel selection system		PLL (I <sup>2</sup> C-bus)*1	
Noise figure (dB)		7 (TYP.)	
Tuning voltage (V DC)		Shared with a 3.3 V power source	
Supply voltage (V DC)		3.3	
LNB power supply		DC 25 V, 400 mA (MAX.)	
Input impedance (Ω)		75	
Outline dimensions (mm)		29.6 × 29.4 × 13.0	30.6 × 25.0 × 13.0

\* Contact SHARP for custom design product. (Vertical chassis compatible)

\*1 I<sup>2</sup>C-bus is a trademark of Philips Corporation.



BS2S7HZ0502

BS2S7HZ6306

#### Notice

In the absence of confirmation by device specification sheets, SHARP takes no responsibility for any defects that may occur in equipment using any SHARP devices shown in catalogs, data books, etc. Contact SHARP in order to obtain the latest device specification sheets before using any SHARP device.

## ■ Digital DBS Front-End Units (QPSK Demodulator Circuit Built-in Type)

### ◆ Specifications <QPSK demodulator circuit built-in type>

Destination	Global
Input type	1-input, 1-loop through output
Model No.	BS2F7VZ7395
Input frequency (MHz)	950 to 2 150
Input signal level (dB m)	-65 to -25
The 1st intermediate frequency (MHz)	Zero-IF (Direct conversion)
Base band frequency bandwidth (MHz)	10 to 30, 2.0 MHz step (BB LPF)
RF input local leak (dB m)	-70 and below
Output type	TS parallel/serial
Symbol rate (M baud)	45 (MAX.)
BER (Viterbi output)	$E_b/N_o = 5.5 \text{ dB (Max.)}$ [PR = 3/4, BER = $2 \times 10^{-4}$ ]
Channel selection system	PLL (I <sup>2</sup> C-bus)*1
Noise figure (dB)	7 (TYP.)
Tuning voltage (V DC)	Shared with a 3.3 V power source
Supply voltage (V DC)	3.3, 2.5
LNB power supply	25 V DC, 400 mA (MAX.)
Input impedance ( $\Omega$ )	75
Outline dimensions (mm)	57.5 × 29.6 × 13.2

\* Contact SHARP for custom design product.

\*1 I<sup>2</sup>C-bus is a trademark of Philips Corporation.

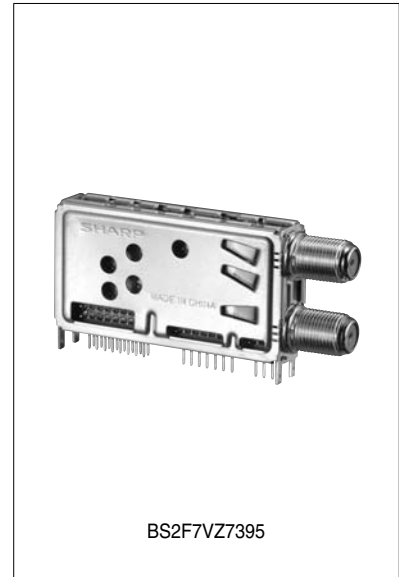

## ■ Digital DBS Front-End Units (8 PSK Demodulator Circuit Built-in Type)

### ◆ Specifications <8 PSK demodulator circuit built-in type>

Destination	Japan (ISDB-S)		Europe (DVB-S2)
	Input type/Features	1-input	1-input, 1-loop through output
Model No.	BS2F7HZ6460	BS2F7VZ0460	BS2F7VZ0165
Input frequency (MHz)	950 to 2 150		
Input signal level (dB m)	-65 to -25		
The 1st intermediate frequency (MHz)	Zero-IF (Direct conversion)		
Base band frequency bandwidth (MHz)	22 (BB LPF) variable type		10 to 30
RF input local leak (dB m)	-70 and below		
Output type	Serial transport output	Parallel/serial transport output	
Symbol rate (M baud)	28.86		10 to 30
Channel selection system	PLL (I <sup>2</sup> C-bus)*1		
Noise figure (dB)	7 (TYP.)		
Tuning voltage (V DC)	Shared with a 3.3 V power source		
Supply voltage (V DC)	3.3, 1.5		3.3, 1.25
LNB power supply	25 V DC, 400 mA (MAX.)		
Input impedance ( $\Omega$ )	75		
Outline dimensions (mm)	65.8 × 26.5 × 14.6	55.1 × 37.9 × 13.2	

\*1 I<sup>2</sup>C-bus is a trademark of Philips Corporation.

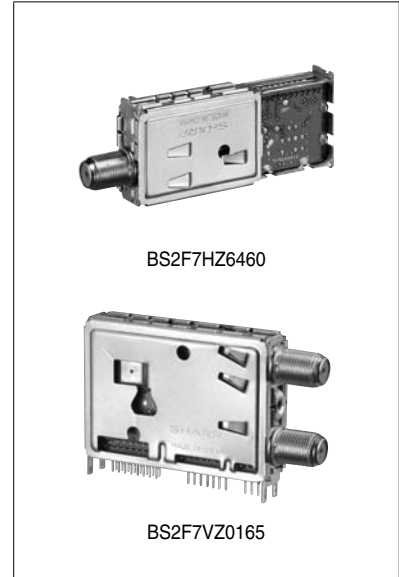

#### Notice

In the absence of confirmation by device specification sheets, SHARP takes no responsibility for any defects that may occur in equipment using any SHARP devices shown in catalogs, data books, etc. Contact SHARP in order to obtain the latest device specification sheets before using any SHARP device.

## ■ Combination Front-End for Digital Terrestrial, Analog Terrestrial and Digital Satellite Broadcasting

### ◆ Features

- (1) Enables simultaneous reception of digital terrestrial and digital satellite, or analog terrestrial and digital satellite, broadcasting.
- (2) Contributes to making LCD TVs, etc. thinner.

### ◆ Standard Specifications

Destination	Japan		
Model No.	VA1R5JF7002		
RF circuit system	Digital terrestrial	Analog terrestrial	Digital DBS
	Single conversion type		Direct conversion type
Input frequency (MHz)	VHF, UHF, CATV VHF Low: 93 to 167 VHF High: 173 to 399 UHF: 405 to 767		1 049.48 to 2 053
Input signal level*1 (dBm)	-75 to -20	-	-65 to -25
Output type	Serial transport	CVBS/SIF	Serial transport
IF bandwidth (MHz)	6		-
IQ Base band frequency bandwidth	-		10 MHz to 30 MHz, 2.0 MHz step (BB LPF)
Noise figure (dB)	6 (TYP.)		6 (TYP.)
PLL phase noise (dBc/Hz)	-90 (TYP.) at 10kHz offset		-80 (TYP.) at 10kHz offset
Image rejection (dB)	65 (TYP.)		-
Channel selection system	PLL (I <sup>2</sup> C-bus)*2		
Supply voltage (V DC)	1.5, 2.5, 3.3, 5.0		
Outline dimensions (mm)	85.5 × 45.2 × 12.7		

\*1 It conforms to the ARIB standard.

\*2 I<sup>2</sup>C-bus is a trademark of Philips Corporation.



#### Notice

In the absence of confirmation by device specification sheets, SHARP takes no responsibility for any defects that may occur in equipment using any SHARP devices shown in catalogs, data books, etc. Contact SHARP in order to obtain the latest device specification sheets before using any SHARP device.

## ■ Front-End Units for ISDB-T/DVB-T

### ◆ Features

- (1) Low phase noise characteristics, high elimination of adjacent channel interference.
- (2) Transport stream output front-end units with built-in OFDM demodulation IC. [VA1L5JF6013/VA1J5ED5055]
- (3) Compact, low power consumption.
- (4) Other types are available with various forms of chassis (vertical or horizontal type) and input connectors (F or DIN type), etc.

### ◆ Standard Specifications

Destination	Japan		Europe/Asia	
Product name	ISDB-T/S front end (built-in OFDM/8PSK demodulation)		DVB-T front end (IF output)	
Model No.	VA1J5JF7007		VA1T1ED5065	VA1H1ED5265
Input frequency (MHz)*1	VHF, UHF, CATV VHF Low: 93 to 167 VHF High: 173 to 399 UHF: 405 to 767	1 049.48 to 2 053	VHF: 143.5 to 430 UHF: 430 to 862	VHF: 146 to 430 UHF: 430 to 862
Output	Transport stream (Built-in OFDM/8PSK demodulation)		Direct IF	
IF bandwidth (MHz)	6	—	7, 8, selectable	
Mode	Mode 1, 2, 3		2k, 8k, both compatible	
Input sensitivity	-79 dBm (TYP.) [in mode 3, 64 QAM, CR = 7/8 (QEF)]	-85 dBm (TYP.)	—	-81 dBm (TYP.) [at 2 k, 64 QAM, CR = 2/3 (QEF)]
Noise figure (dB)	6 (TYP.)	8 (TYP.)	6 (TYP.)	
Phase noise	-90 dBc/Hz (TYP.) [at 10 kHz offset]	-80 dBc/Hz (TYP.)	-90 dBc/Hz (TYP.) [at 10 kHz offset]	
Image rejection (dB)	65 (TYP.)	—	55 (TYP.)	—
C/N	21.5 dB (TYP.) [at input level: -45 dBm, in mode 3, 64 QAM, CR = 7/8 (QEF)]	85 dB (TYP.) [8PSK, PC = 2/3 BW = 28.9 MHz]	—	17.2 dB (TYP.) [at input level: -50 dBm, 64 QAM, CR = 2/3 (QEF)]
Channel selection/control system	PLL (I <sup>2</sup> C-bus)*2			
Power consumption (W)	2.0*3		0.75	0.85
Supply voltage (V DC)	1.2, 2.5, 3.3, 5		5 (DC-DC converter)	
Outline dimensions (mm)	70.0 x 36.9 x 12.5		52.0 x 35.9 x 13.4	47.7 x 29.6 x 13.2

\*1 Enables simultaneous reception of digital terrestrial and digital satellite broadcasting.

\*2 I<sup>2</sup>C-bus is a trademark of Philips Corporation.

\*3 During simultaneous OFDM/8PSK demodulation operation.



#### Notice

In the absence of confirmation by device specification sheets, SHARP takes no responsibility for any defects that may occur in equipment using any SHARP devices shown in catalogs, data books, etc. Contact SHARP in order to obtain the latest device specification sheets before using any SHARP device.



## Two-In-One RF Units (RF Front-End Unit + PIF Unit)

### ◆ Features

- (1) High performance RF front-end unit and PIF unit are integrated in one unit, resulting in a short developing time.
- (2) A composite unit structure improves operability during mounting.
- (3) Horizontal shaped models for LCD TVs/LCD monitors are available.  
(Vertical shaped models are also available.)

### ◆ Specifications

TV system	North America <Digital/Analog>				Europe <Digital/Analog>				China/Asia <Analog>				
Model No.	VA1Y2UF2307/VA1Y2UF2312				VA1Y2ED1401				VT2W5CD551				
Receiving channels (ch) Input frequency	VHF		UHF		VHF-Low: 50.5 to 142.5 MHz VHF-High: 149.5 to 426 MHz UHF: 434 to 858 MHz	VHF		UHF					
	Air	CATV	CATV	Air		Air	CATV	CATV	Air				
	1 to 13	A5 to W+11	W+12 to W+84	14 to 69		1 to 12	1A, Z1 to Z33	Z34 to Z38	13 to 57				
Analog band split	BL: 2 to 6, A5 to B BH: 7 to 13, C to W+11 BU: 14 to 69, W+12 to W+84				BL: 2 to 4, X to S6 BH: 5 to 12, S7 to S36 BU: 13 to 69, S37 to S41				BL: 1 to 5, 1A, Z1 to Z4 BH: 6 to 12, Z5 to Z33 BU: 13 to 57, Z34 to Z38				
Analog intermediate frequency (MHz)	Video	45.75			B/G, I, D/K, L: 39.875 L': 33.125				38.0				
	Audio	41.25			D/K, L: 33.375 I: 33.875 B/G: 34.375 L': 39.625				D/K: 31.5, I: 32.0, B/G: 32.5, M/N: 33.5				
Digital intermediate frequency (MHz)	44				36.0				—				
Digital IF bandwidth (MHz)	6				7/8 (switchable)				—				
Phase noise	-80dBc/Hz (Typ.) at 20kHz offset				-85dBc/Hz (Typ.) at 10kHz offset				—				
Detection system	Pseudo synchronization detection system, split-carrier audio receiving system												
Terminals	Input: F-type junction, SO				Input: DIN type terminal				Input: DIN type terminal				
Input impedance (Ω)					75								
RF with loop through	—				—*2				—*2				
B voltage (V DC)	MB: 5				MB: 5/BT: 31				MB: 5/BT: 31				
RF front-end	Noise figure (dB)	6	6	7	7	Typ. 6				6	7	6	6
	Type	Digital analog receiver front end											
	Channel selection system	PLL (I <sup>2</sup> C-bus)*1											
	Image rejection (dB)	VL: 65, VH: 65		60		Typ. 65				VL: 70, VH: 70		55	
	IF rejection (dB)	VL: 75, VH: 85		100		Typ. 100				VL: 50 to 70, VH: 90		90	
IF	Video output level (Vp-p)	1.0			1.0				1.0				
	Video output S/N (dB)	48			50				44				
	Noise limit sensitivity (dBμ) at S/N = 30 dB	42			42				42				
	Audio output level (mVrms)	—			—				290				
	Audio output S/N (dB)	—			—				45				
	Audio frequency characteristics (at 70 kHz)	—			—				-0 (at 10 kHz)				
SIF output	Possible to SIF output												
Outline dimensions (mm)	65.0 × 40.4 × 15.0				61.5 × 35.2 × 10.9				60.9 × 41.5 × 15.0				

\*1 I<sup>2</sup>C-bus is a trademark of Philips Corporation.

\*2 Compatible with RF loop through type.

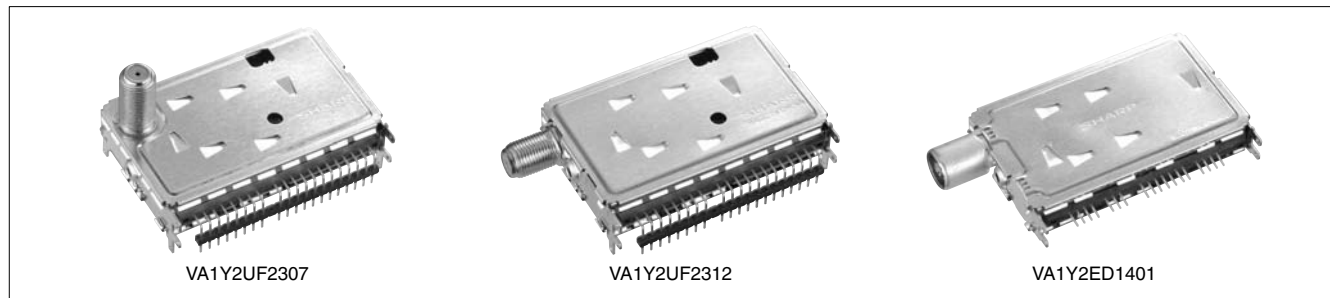

#### Notice

In the absence of confirmation by device specification sheets, SHARP takes no responsibility for any defects that may occur in equipment using any SHARP devices shown in catalogs, data books, etc. Contact SHARP in order to obtain the latest device specification sheets before using any SHARP device.

## RF Front-End Units

### <VT1Y Series>

#### ◆ Features

- (1) Miniature size achieved using thin profile, low height design in industry standard RF front-end unit (terminal shape and terminal pin arrays)
- (2) Model lineup corresponding to domestic product standards of Europe, China, Japan and the United States.

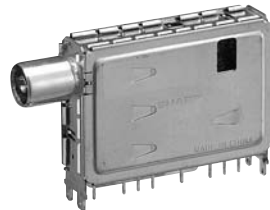

DIN-type junction input type

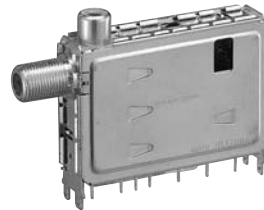

With RF output terminal type

#### ◆ Specifications (Major models of VT1Y series)

Destination	Europe				U.S.A.				China/Asia				Japan							
Type	CS, for frequency synthesizer IF output*1: No equilibrium				With PLL, for frequency synthesizer, F-type junction input				GB, hyper, for frequency synthesizer				With PLL, for frequency synthesizer				With PLL, for frequency synthesizer, with RF output			
Model No.	VT1Y5ED211				VT1Y5UF201				VT1Y5CD201				VT1Y5JF201				VT1Y5JB201			
Receiving channel (ch)	VHF		UHF		VHF		UHF		VHF		UHF		VHF		UHF		VHF		UHF	
	Air	CATV	CATV	Air	Air	CATV	CATV	Air	Air	CATV	CATV	Air	Air	CATV	CATV	Air	Air	CATV	CATV	Air
	2 to 12	X to S36	S37 to S41	21 to C57	2 to 13	A-5 to W+11	W+12 to W+84	14 to 69	1 to 12	1A, Z1 to Z33	Z34 to Z38	13 to 57	1 to 12	C13 to C52	C53 to C63	13 to 62	1 to 12	C13 to C52	C53 to C63	13 to 62
Band split	BL: 2 to 4, X to S6 BH: 5 to 12, S7 to S36 BU: 21 to C57, S37 to S41				BL: 2 to 6, A-5 to B BH: 7 to 13, C to W+11 BU: 14 to 69, W+12 to W+84				BL: 1 to 5, 1A, Z1 to Z4 BH: 6 to 12, Z5 to Z33 BU: 13 to 57, Z34 to Z38				BL: 1 to 3, C13 to C22 BH: 4 to 12, C23 to C52 BU: 13 to 62, C53 to C63				BL: 1 to 3, C13 to C22 BH: 4 to 12, C23 to C52 BU: 13 to 62, C53 to C63			
Intermediate frequency (MHz)	Video	38.9			45.75			38.0			58.75									
	Audio	33.4			41.25			31.5			54.25									
B voltage (V DC)	+B: 5/BT: 31				+B: 5/BT: 31.5				+B: 5/BT: 31				+B: 5/BT: 31.5							
Input impedance (Ω)	75																			
VSWR	2	2	2	1.5	1.5	1.5	2	2	2	1.5	1.5	1.5	-	-	-					
Noise figure (dB)	5	7	6	5	5	6	5	7	6	4	5	4.5	8	9	8.5					
Power gain (dB)	40	38	40	39	39	37	40	38	40	40	37	40	36	33	36					
Image rejection (dB)	VL: 70 VH: 65		60		VL: 70 VH: 60		60		VL: 70 VH: 65		60		VL: 85 VH: 85		80		VL: 85 VH: 85		80	
IF rejection (dB)	VL: 70 VH: 90		90		VL: 80 VH: 90		85		VL: 70 VH: 90		90		VL: 85 VH: 85		100		VL: 85 VH: 85		100	
Outline dimensions (mm)	53.0 × 33.6 × 14.3																			

(Note) The figures in the table are typical values.

\*1 Available IF output equilibrium model

#### Notice

In the absence of confirmation by device specification sheets, SHARP takes no responsibility for any defects that may occur in equipment using any SHARP devices shown in catalogs, data books, etc. Contact SHARP in order to obtain the latest device specification sheets before using any SHARP device.

## ■ 1-Segment Digital Terrestrial Module

### ◆ Features

- (1) High sensitivity: -109 dBm [typ.] (GFSK, CR1/2 ch13)
- (2) Compact and thin design: 9.0 x 9.0 x 1.5 mm
- (3) Low power consumption: 95 mW\*1
- (4) Output interface: TS serial output

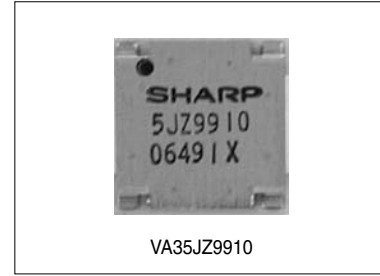

### ◆ Standard Specifications

Destination	Japan
Model No.	VA35JZ9910
Input frequency	470 to 770 MHz (UHF: 13 to 62)
Input signal level	-109 dBm [typ.] (GFSK, CR1/2)
Supply voltage	2.9 V (RF) 1.5 V (OFDM Core) 1.8 V to 2.9 V (I/O)
Power consumption	95 mW*1
Operating temperature	-20 to 85°C
Control I/F	I <sup>2</sup> C-bus*2
Power off function	OFF for RF/OFDM power supply, 2 μA (MAX.) for I/O power supply (ON state)

\*1 Average value when current consumption is controlled by software

\*2 I<sup>2</sup>C-bus is a trademark of Philips Corporation.

## ■ 1-segment/3-segment Digital Terrestrial Module

### ◆ Features

- (1) High sensitivity: -109 dBm [typ.] (QPSK, CR1/2 ch15)  
-110 dBm [typ.] (QPSK, CR1/2 ch7)
- (2) Compact and thin design: 9.0 x 9.0 x 1.5 mm
- (3) Low power consumption: 125 mW (at 3-segment), 120 mW (at 1-segment)
- (4) Output interface: TS serial output



### ◆ Standard Specifications

Destination	Japan
Model No.	VA35JZ9904
Input frequency	188 to 198 MHz (UHF: 7, 8) 470 to 770 MHz (UHF: 13 to 62)
Input signal level	-109 dBm [typ.] (GFSK, CR1/2, ch7) -110 dBm [typ.] (GFSK, CR1/2, ch15)
Supply voltage	1.8 V (RF) 1.2 V (OFDM Core) 1.8 V to 2.8 V (I/O)
Power consumption	125 mW (at 3-segment), 120 mW (at 1-segment)
Operating temperature	-20 to 85°C
Control I/F	I <sup>2</sup> C-bus*1
Power off function	All power supplies can be OFF.

\*1 I<sup>2</sup>C-bus is a trademark of Philips Corporation.

#### Notice

In the absence of confirmation by device specification sheets, SHARP takes no responsibility for any defects that may occur in equipment using any SHARP devices shown in catalogs, data books, etc. Contact SHARP in order to obtain the latest device specification sheets before using any SHARP device.

## ■ USB Interface Wireless LAN Module

### ◆ Features

- (1) Interface: USB2.0
- (2) Supports security functions.  
 [Encryption method: WEP (64 bit/128 bit), TKIP, AES  
 Authentic method: IEEE802.1x (TLS/PEAP/LEAP), WPA (TLS/PEAP)]

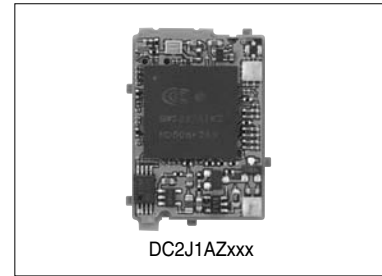

### ◆ Specifications

Standard	IEEE802.11b (option: IEEE802.11g)
Model No.	DC2J1AZxxx (Japan)*1
Output connector	B to B, 10 pin & Antenna connector
Power amp.	Included
Current	Uplink (FTP): 440 mW (typ.)*2 Downlink (FTP): 410 mW (typ.)*2
FTP throughput (Mbps)	4.5 (typ.) [Using FTP 'get' command]*2
Clock (MHz)	40 (included)
Voltage (V DC)	3.3±5%
Outline dimensions (mm)	20 × 30 × 3.8

Driver software consults separately.

\*1 Different models are available in accordance with the laws of the country where the product is to be sold or used.

\*2 Measurement of FTP of specifications description.

#### Notice

In the absence of confirmation by device specification sheets, SHARP takes no responsibility for any defects that may occur in equipment using any SHARP devices shown in catalogs, data books, etc. Contact SHARP in order to obtain the latest device specification sheets before using any SHARP device.



## ■ Infrared Data Communication Device Lineup

Communication system	Transmission speed	Transmission distance	Features	Operating supply voltage	Model No.	
IrDA data (IrDA 1.x)	FIR 4 Mb/s	100 cm	Compact, thin (height: 2.5 mm), low voltage operation type, LP/HP mode switching function	2.4 to 3.6 V	GP2W1004YP0F	
			Compact	2.7 to 5.5 V	GP2W1001YP0F	
		70 cm	LP/HP mode switching function		GP2W1010YP0F	
			50/20 cm	LP/HP mode switching and remote control transmission functions		GP2W3120YP0F
	FIR LP 4 Mb/s	50/20 cm	LP/HP mode switching function	2.7 to 3.6 V	GP2W1320YP0F	
	FIR LP 4 Mb/s	70/20 cm	LP/MP/HP mode switching and remote control transmission functions	2.6 to 3.3 V	GP2W3104YP0F	
	MIR 1.152 Mb/s	100 cm	Compact, low dissipation current	2.4 to 3.6 V	GP2W1002YP0F	
			70 cm	2.4 to 3.6 V	GP2W1302YP0F	
			50 cm	2.4 to 3.6 V	GP2W1304YP	
	SIR 115.2 kb/s	100 cm	Compact, low dissipation current	2.4 to 5.5 V	GP2W0004YP0F/ GP2W0004XP0F	
			80 cm	Remote control transmission function, compact, low dissipation current	2.4 to 5.5 V	GP2W3020YP
	SIR LP 115.2 kb/s	20 cm	Built-in LED constant current circuit, 3-state output		2.0 to 3.6 V	GP2W0110VX/ GP2W0110VY
				Compact	2.0 to 3.6 V	GP2W0116YP0F
				(Height: 1.5 mm)	2.4 to 3.6 V	GP2W0150YP0F
			Built-in LED constant current circuit, 3-state output, top view type		2.0 to 3.6 V	GP2W0114YP0F
				Compact	2.0 to 3.6 V	GP2W0118YP0F
				(Height: 2.1 mm)	2.4 to 3.6 V	GP2W0150XP0F
			Built-in LED constant current circuit, 3-state output, low voltage operation type, low dissipation current type		1.8 to 2.5 V	GP2W0112YP0F
Remote control transmission function (built-in drive circuit)			$\lambda$ p: 870, 940 nm	2.4 to 3.6 V	GP2W3240YP	
			$\lambda$ p: 890 nm	2.4 to 3.6 V	GP2W3250YP	
			(Height: 1.5 mm)	2.4 to 3.6 V	GP2W3270YP0F	
	Top view type	2.4 to 3.6 V	GP2W3270XP0F			

## ■ Infrared Wireless Audio Transmission Device Lineup

Communication system	Features	Operating supply voltage	Model No.
Infrared system (1-bit audio transmission)	For designing compact, low-power-consumption audio transmission systems	2.4 to 3.6 V	GP2WVR01YP0F/ GP2WVC01MP0F (Transmission LSI)

☆New product  
★Under development



## ■ Infrared Data Communication Devices

### ◆ IrDA FIR Compliant Devices

Model No.	Communication system	Transmission rate	Description	Transmission distance (cm)	Supply voltage (V DC)	Outline dimensions (mm)
☆GP2W3120YP0F	Bi-directional (half-duplex) communication	9.6 k to 4 Mb/s	With remote control transmission function, LP/HP mode switching function	50/20*1	2.4 to 3.6	7.16 × 2.73 × 1.82
☆GP2W1010YP0F	Bi-directional (half-duplex) communication	9.6 k to 4 Mb/s	LP/HP mode switching function	70	2.4 to 3.6	7.9 × 2.85 × 2.15
★GP2W1004YP0F	Bi-directional (half-duplex) communication	9.6 k to 4 Mb/s	LP/HP mode switching function	100	2.4 to 3.6	7.9 × 2.85 × 2.5
GP2W1001YP0F	Bi-directional (half-duplex) communication	9.6 k to 4 Mb/s		100	2.7 to 5.5	10.01 × 4.4 × 3.5
☆GP2W1320YP0F	Bi-directional (half-duplex) communication	9.6 k to 4 Mb/s	Compact, thin, low dissipation current during shutdown (Icc: TYP. 0.45 mA)	50/20*1	2.7 to 3.6	7.16 × 2.73 × 1.82
☆GP2W3104YP0F	Bi-directional (half-duplex) communication	9.6 k to 4 Mb/s	Compact, thin, with remote control transmission function, LP/MP/HP mode switching function	70/20*2	2.6 to 3.3	7.9 × 2.85 × 2.5

\*1 MIN. 20 cm at 150 mA MIN. 50 cm at 250 mA  
\*2 MIN. 21 cm at 150 mA MIN. 70 cm at 450 mA



### ◆ IrDA MIR Compliant Devices

Model No.	Communication system	Transmission rate	Description	Transmission distance (cm)	Supply voltage (V DC)	Outline dimensions (mm)
GP2W1002YP0F	Bi-directional (half-duplex) communication	9.6 k to 1.152 Mb/s		100	2.4 to 3.6	8.0 × 3.0 × 2.5
GP2W1302YP0F	Bi-directional (half-duplex) communication	9.6 k to 1.152 Mb/s	Compact, compatible with 2.15 mm height for mobile phone	70	2.4 to 3.6	7.9 × 2.85 × 2.15
GP2W1304YP	Bi-directional (half-duplex) communication	9.6 k to 1.152 Mb/s	Compact, compatible with 1.82 mm height for mobile phone	50	2.4 to 3.6	7.16 × 2.73 × 1.82



### ◆ IrDA SIR Compliant Front-Ends

Model No.	Communication system	Transmission rate	Description	Transmission distance (cm)	Supply voltage (V DC)	Outline dimensions (mm)
GP2W0004YP0F	Bi-directional (half-duplex) communication	9.6 k to 115.2 kb/s	Low dissipation current (Icc: 130 μA MAX.)	100	2.4 to 5.5	9.21 × 3.76 × 2.71
GP2W0004XP0F	Bi-directional (half-duplex) communication	9.6 k to 115.2 kb/s	Low dissipation current (Icc: 130 μA MAX.)	100	2.4 to 5.5	9.2 × 3.35 × 2.95
GP2W3020YP	Bi-directional (half-duplex) communication	9.6 k to 115.2 kb/s	With remote control transmission function (Transmission distance TYP. 7 m, I <sub>F</sub> = 350 mA) Low dissipation current during shutdown (Icc: 130 μA MAX.)	80	2.4 to 5.5	7.9 × 2.85 × 2.15



#### Notice

In the absence of confirmation by device specification sheets, SHARP takes no responsibility for any defects that may occur in equipment using any SHARP devices shown in catalogs, data books, etc.  
Except where specially indicated, models listed on this page comply with the RoHS Directive\*. For details, please contact SHARP.  
\*RoHS Directive: Prohibits use of lead, cadmium, hexavalent chromium, mercury and specific brominated flame retardants (PBBs and PBDEs), with certain exceptions.  
Contact SHARP in order to obtain the latest device specification sheets before using any SHARP device.

# INFRARED DATA COMMUNICATION DEVICE



## ◆IrDA SIR LP Compliant Front-Ends

Model No.	Communication system	Transmission rate	Description	Transmission distance (cm)	Supply voltage (V DC)	Outline dimensions (mm)
GP2W0110VX/VY	Bi-directional (half-duplex) communication	2.4 k to 115.2 kb/s	Top-view and side view compatible (Model name is prescribed based on the packaging status.), lead-free type available	20	2.0 to 3.6	6.8 × 2.35 × 2.1
GP2W0112YP0F▲	Bi-directional (half-duplex) communication	2.4 k to 115.2 kb/s	Low voltage operation, low dissipation current, 3-state output type, independent power supply for light-emitting and light-detecting circuits	20	1.7 to 2.5	7.9 × 2.85 × 2.15
GP2W0150YP0F	Bi-directional (half-duplex) communication	2.4 k to 115.2 kb/s	Compact, thin, low dissipation current (Icc: 100 μA MAX.)	20	2.4 to 3.6	7.6 × 2.4 × 1.5
GP2W0150XP0F	Bi-directional (half-duplex) communication	2.4 k to 115.2 kb/s	Compact, thin, low dissipation current (Icc: 100 μA MAX.) Top view type	20	2.4 to 3.6	8.3 × 2.1 × 1.7
GP2W0116YP0F▲	Bi-directional (half-duplex) communication	2.4 k to 115.2 kb/s	Compact, thin, low dissipation current (Icc: 120 μA MAX.)	20	2.0 to 3.6	7.2 × 2.75 × 1.85
GP2W0118YP0F▲	Bi-directional (half-duplex) communication	2.4 k to 115.2 kb/s	Compact, thin, low dissipation current (Icc: 120 μA MAX.) Top view type	20	2.0 to 3.6	7.9 × 2.25 × 2.0
GP2W3240YP▲	Bi-directional (half-duplex) communication	2.4 k to 115.2 kb/s	With remote control transmit function (with remote control drive circuit) (λp = 940 nm) IR communication part (λp = 870 nm)	20	2.4 to 3.6	8.6 × 2.85 × 1.85
GP2W3250YP	Bi-directional (half-duplex) communication	2.4 k to 115.2 kb/s	Remote control transmission function, shared IR communication section (λp = 890 nm)	20	2.4 to 3.6	7.2 × 2.55 × 1.85
GP2W3270YP0F	Bi-directional (half-duplex) communication	2.4 k to 115.2 kb/s	Remote control transmission function, shared IR communication section (λp = 890 nm)	20	2.4 to 3.6	7.6 × 2.4 × 1.5
GP2W3270XP0F	Bi-directional (half-duplex) communication	2.4 k to 115.2 kb/s	Remote control transmission function, shared IR communication section (λp = 890 nm) Top view type	20	2.4 to 3.6	8.3 × 2.1 × 1.7

The model marked with ▲ may not be available in the near future. Contact with SHARP for details before use.

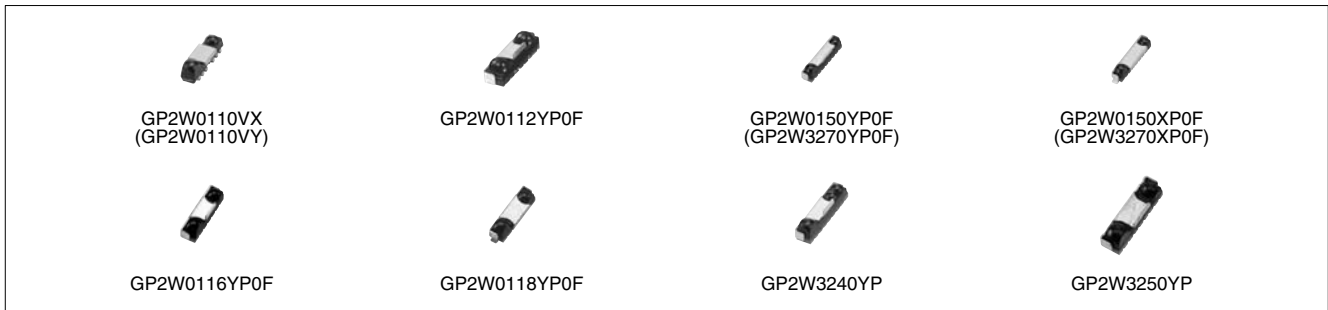

## ■ Infrared Wireless Audio Transmission Device

Model No.	Communication system	Features	S/N ratio	Supply voltage (V DC)	Outline dimensions (mm)
GP2WVR01YP0F (Reception Device)	1-bit audio transmission (1.5 MHz)	Compact, low power consumption type Simple circuit configuration: Used in combination with transmission LSI (GP2WVC01MP0F) and transmission device (GP2W1004YP0F, etc.)	70 dB	2.4 to 3.6	2.5 × 8 × 3



### Notice

In the absence of confirmation by device specification sheets, SHARP takes no responsibility for any defects that may occur in equipment using any SHARP devices shown in catalogs, data books, etc.  
Except where specially indicated, models listed on this page comply with the RoHS Directive\*. For details, please contact SHARP.  
\*RoHS Directive: Prohibits use of lead, cadmium, hexavalent chromium, mercury and specific brominated flame retardants (PBBs and PBDEs), with certain exceptions.  
Contact SHARP in order to obtain the latest device specification sheets before using any SHARP device.

## IR Detecting Unit for Remote Control Lineup

Type	Package		Features	Model No.			
	Form	Detection position*5 (from PCB)		Operating voltage: 3 V	Operating voltage: 5 V	Operating voltage: 3 to 5 V	
IR detecting unit for remote control	Lead L bend with holder	16.0 mm*1	Compact size	GP1UE28XK0VF series	GP1UM28XK0VF series		
			Compact size, Strengthened resistance to electromagnetic induction noise (Mesh type)	GP1UE28RK0VF series	GP1UM28RK0VF series		
			Low dissipation current			GP1UD28XK00F series	
		12.0 mm*2	Compact size	GP1UE27XK0VF series	GP1UM27XK0VF series		
			Compact size, Strengthened resistance to electromagnetic induction noise (Mesh type)	GP1UE27RK0VF series	GP1UM27RK0VF series		
			Low dissipation current			GP1UD27XK00F series	
		6.8 mm*3	Compact size	GP1UE26XK0VF series	GP1UM26XK0VF series		
			Compact size, Strengthened resistance to electromagnetic induction noise (Mesh type)	GP1UE26RK0VF series	GP1UM26RK0VF series		
			Low dissipation current			GP1UD26XK00F series	
		Lead straight with holder	19.0 mm	Compact size, Strengthened resistance to electromagnetic induction noise (Mesh type)	GP1UE29QK0VF series	GP1UM29QK0VF series	
				Compact size	GP1UE28YK0VF series	GP1UM28YK0VF series	
				Compact size, Strengthened resistance to electromagnetic induction noise (Mesh type)	GP1UE28QK0VF series	GP1UM28QK0VF series	
				Low dissipation current			GP1UD28YK00F series
		Compact, thin type SMD (4.1 × 3.84 × 0.95 t mm)					GP1US30XP series
		Compact type SMD (6.8 × 2.1 × 2.35 t mm)					GP1UF31 series
Holderless	Lead straight 6.0 mm		GP1UX31QS series	GP1UX51QS series			
	Lead L bend*4 5.3 mm		GP1UX31RK series	GP1UX51RK series			

\*1 Mesh type (strengthened resistance to electromagnetic induction noise): 16.4 mm

\*2 Mesh type: 12.4 mm

\*3 Mesh type: 7.2 mm

\*4 Mesh type: 5.3 mm

\*5 Lead straight: Distance from lens center to mounting board upper surface

No mesh lead L bend: Distance from tip of lens to mounting board upper surface

Mesh-type lead L bend: Distance from tip of mesh to mounting board upper surface



# IR DETECTING UNIT FOR REMOTE CONTROL

☆New product



## IR Detecting Units for Remote Control

(Ta = 25°C)

Series No.	Absolute maximum ratings		Electrical characteristics				Size (mm)	Remarks
	Vcc (V)	Topt (°C)	Icc (mA) <sup>*1</sup> MAX.	V <sub>OH</sub> (V) MIN.	V <sub>OL</sub> (V) MAX.	f <sub>o</sub> (kHz) TYP.		
GP1UM26XKOVF <sup>*12</sup>	0 to 6.0	-10 to +70	0.6 (0.65) <sup>*18</sup>	Vcc-0.5 <sup>*10</sup>	0.45 <sup>*10</sup>	40 <sup>*3</sup>	5.6 × 9.6 × 6.8	<sup>*5</sup>
GP1UM27XKOVF <sup>*12</sup>	0 to 6.0	-10 to +70	0.6 (0.65) <sup>*18</sup>	Vcc-0.5 <sup>*10</sup>	0.45 <sup>*10</sup>	40 <sup>*3</sup>	5.6 × 9.6 × 12.0	<sup>*5</sup>
GP1UM28XKOVF <sup>*12</sup>	0 to 6.0	-10 to +70	0.6 (0.65) <sup>*18</sup>	Vcc-0.5 <sup>*10</sup>	0.45 <sup>*10</sup>	40 <sup>*3</sup>	5.6 × 9.6 × 16.0	<sup>*5</sup>
GP1UM28YKOVF <sup>*12</sup>	0 to 6.0	-10 to +70	0.6 (0.65) <sup>*18</sup>	Vcc-0.5 <sup>*10</sup>	0.45 <sup>*10</sup>	40 <sup>*3</sup>	5.6 × 8.6 × 12.5(9.6) <sup>*2</sup>	<sup>*5</sup>
GP1UM26RKOVF <sup>*4, *12</sup>	0 to 6.0	-10 to +70	0.6 (0.65) <sup>*18</sup>	Vcc-0.5 <sup>*11</sup>	0.45 <sup>*11</sup>	40 <sup>*3</sup>	5.6 × 9.6 × 7.2	<sup>*5</sup>
GP1UM27RKOVF <sup>*4, *12</sup>	0 to 6.0	-10 to +70	0.6 (0.65) <sup>*18</sup>	Vcc-0.5 <sup>*11</sup>	0.45 <sup>*11</sup>	40 <sup>*3</sup>	5.6 × 9.6 × 12.4	<sup>*5</sup>
GP1UM28RKOVF <sup>*4, *12</sup>	0 to 6.0	-10 to +70	0.6 (0.65) <sup>*18</sup>	Vcc-0.5 <sup>*11</sup>	0.45 <sup>*11</sup>	40 <sup>*3</sup>	5.6 × 9.6 × 16.4	<sup>*5</sup>
GP1UM28QKOVF <sup>*4, *12</sup>	0 to 6.0	-10 to +70	0.6 (0.65) <sup>*18</sup>	Vcc-0.5 <sup>*11</sup>	0.45 <sup>*11</sup>	40 <sup>*3</sup>	5.6 × 9.0 × 12.5(9.6) <sup>*2</sup>	<sup>*5</sup>
GP1UM29QKOVF <sup>*4, *12</sup>	0 to 6.0	-10 to +70	0.6 (0.65) <sup>*18</sup>	Vcc-0.5 <sup>*11</sup>	0.45 <sup>*11</sup>	40 <sup>*3</sup>	5.6 × 16.2 × 21.9(19) <sup>*2</sup>	<sup>*5</sup>
GP1UE26XKOVF <sup>*8</sup>	0 to 6.0	-10 to +70	0.4	Vcc-0.5 <sup>*9</sup>	0.45 <sup>*9</sup>	40 <sup>*16</sup>	5.6 × 9.6 × 6.8	<sup>*5</sup>
GP1UE27XKOVF <sup>*8</sup>	0 to 6.0	-10 to +70	0.4	Vcc-0.5 <sup>*9</sup>	0.45 <sup>*9</sup>	40 <sup>*16</sup>	5.6 × 9.6 × 12.0	<sup>*5</sup>
GP1UE28XKOVF <sup>*8</sup>	0 to 6.0	-10 to +70	0.4	Vcc-0.5 <sup>*9</sup>	0.45 <sup>*9</sup>	40 <sup>*16</sup>	5.6 × 9.6 × 16.0	<sup>*5</sup>
GP1UE28YKOVF <sup>*8</sup>	0 to 6.0	-10 to +70	0.4	Vcc-0.5 <sup>*9</sup>	0.45 <sup>*9</sup>	40 <sup>*16</sup>	5.6 × 8.6 × 12.5(9.6) <sup>*2</sup>	<sup>*5</sup>
GP1UE26RKOVF <sup>*8</sup>	0 to 6.0	-10 to +70	0.4	Vcc-0.5 <sup>*14</sup>	0.45 <sup>*14</sup>	40 <sup>*16</sup>	5.6 × 9.6 × 7.2	<sup>*5</sup>
GP1UE27RKOVF <sup>*8</sup>	0 to 6.0	-10 to +70	0.4	Vcc-0.5 <sup>*14</sup>	0.45 <sup>*14</sup>	40 <sup>*16</sup>	5.6 × 9.6 × 12.4	<sup>*5</sup>
GP1UE28RKOVF <sup>*8</sup>	0 to 6.0	-10 to +70	0.4	Vcc-0.5 <sup>*14</sup>	0.45 <sup>*14</sup>	40 <sup>*16</sup>	5.6 × 9.6 × 16.4	<sup>*5</sup>
GP1UE28QKOVF <sup>*8</sup>	0 to 6.0	-10 to +70	0.4	Vcc-0.5 <sup>*14</sup>	0.45 <sup>*14</sup>	40 <sup>*16</sup>	5.6 × 9.0 × 12.5(9.6) <sup>*2</sup>	<sup>*5</sup>
GP1UE29QKOVF <sup>*8</sup>	0 to 6.0	-10 to +70	0.4	Vcc-0.5 <sup>*14</sup>	0.45 <sup>*14</sup>	40 <sup>*16</sup>	5.6 × 16.2 × 21.9(19) <sup>*2</sup>	<sup>*5</sup>
GP1UD26XK00F <sup>*8</sup>	0 to 6.0	-10 to +70	0.2 (Vcc = 3 V)	Vcc-0.5 <sup>*9</sup>	0.5 <sup>*9</sup>	40 <sup>*3</sup>	7.3 × 13.1 × 6.8	<sup>*5</sup>
GP1UD27XK00F <sup>*8</sup>	0 to 6.0	-10 to +70	0.2 (Vcc = 3 V)	Vcc-0.5 <sup>*9</sup>	0.5 <sup>*9</sup>	40 <sup>*3</sup>	7.3 × 13.1 × 12.0	<sup>*5</sup>
GP1UD28XK00F <sup>*8</sup>	0 to 6.0	-10 to +70	0.2 (Vcc = 3 V)	Vcc-0.5 <sup>*9</sup>	0.5 <sup>*9</sup>	40 <sup>*3</sup>	7.3 × 13.1 × 16.0	<sup>*5</sup>
GP1UD28YK00F <sup>*8</sup>	0 to 6.0	-10 to +70	0.2 (Vcc = 3 V)	Vcc-0.5 <sup>*9</sup>	0.5 <sup>*9</sup>	40 <sup>*3</sup>	7.3 × 8.4 × 13.0(9.6) <sup>*2</sup>	<sup>*5</sup>
GP1UV70QS00F <sup>*13</sup>	-	-10 to +70	1.5	Vcc-0.5 <sup>*11</sup>	0.45 <sup>*11</sup>	40 <sup>*3</sup>	5.6 × 6.2 × 7.6(6.0) <sup>*2</sup>	<sup>*5</sup> , Pin configuration (Pin No. 2: GND)
GP1UW70QS00F <sup>*7</sup>	-	-10 to +70	0.6	Vcc-0.5	0.45	40 <sup>*3</sup>	5.6 × 6.2 × 7.6(6.0) <sup>*2</sup>	<sup>*5</sup> , Pin configuration (Pin No. 2: GND)
GP1UX51QS <sup>*13</sup>	0 to 6.0	-10 to +70	0.6	Vcc-0.5 <sup>*11</sup>	0.45 <sup>*11</sup>	40 <sup>*16</sup>	5.5 × 5.3 × 7.5	<sup>*5</sup> , Pin configuration (Pin No. 2: GND)
GP1UX51RK <sup>*13</sup>	0 to 6.0	-10 to +70	1.5	Vcc-0.5	0.45	40 <sup>*3</sup>	5.5 × 5.3 × 7.5	<sup>*5</sup> , Pin configuration (Pin No. 2: GND), Folded lead
GP1UX31QS <sup>*7, *8</sup>	0 to 6.0	-10 to +70	0.4	Vcc-0.5 <sup>*14</sup>	0.45 <sup>*14</sup>	40	5.5 × 5.3 × 7.5	<sup>*5</sup> , Pin configuration (Pin No. 2: GND)
GP1UX31RK <sup>*8</sup>	0 to 6.0	-10 to +70	0.4	Vcc-0.5 <sup>*14</sup>	0.45 <sup>*14</sup>	40	5.5 × 5.3 × 7.5	<sup>*5</sup> , Pin configuration (Pin No. 2: GND), Folded lead
GP1US30XP <sup>*6, *17</sup>	-	-30 to +85	0.6	Vcc-0.5 <sup>*11</sup>	0.45 <sup>*19</sup>	40	4.1 × 3.95 × 0.95	<sup>*5</sup> , Surface mount compatible
☆GP1UF31xXP0F	0 to 6.0	-30 to +85	0.4	Vcc-0.5	0.45	40 <sup>*20</sup>	6.8 × 2.1 × 2.0	<sup>*5</sup> , Surface mount compatible
☆GP1UF31xYP0F	0 to 6.0	-30 to +85	0.4	Vcc-0.5	0.45	40 <sup>*20</sup>	6.8 × 2.1 × 2.0	<sup>*5</sup> , Surface mount compatible

- \*1 When no signal is input (during input light).
- \*2 Figures in parentheses indicate the distance to the light detection center.
- \*3 In addition to the fo = 40kHz type, types fo = 36, 38, 36.7, 56.8, 32.75 kHz are also available.
- \*4 Type with strengthened resistance to electromagnetic induction noise.
- \*5 A voltage regulator circuit is built-in but may be affected by the usage environment. Install with an externally mounted C and R as a power supply filter.
- \*6 Allows reflow soldering.
- \*7 Operating voltage: 2.4 to 3.6 V (2.7 to 3.6 V for fo = 56.8 kHz type)
- \*8 Operating voltage: 2.7 to 5.5 V
- \*9 Distance to transmitter on optical axis is 0.2 to 10.0 m. Ev < 10 lx when burst wave is input as shown in the right figure.
- \*10 Distance to transmitter on optical axis is 0.2 to 10.0 m. Ev < 10 lx when burst wave is input as shown in the right figure. (fo = 56.8 kHz: 0.2 to 9.0 m)
- \*11 Distance to transmitter on optical axis is 0.2 to 8.5 m. Ev < 10 lx when burst wave is input as shown in the right figure. (fo = 56.8 kHz: 0.2 to 7.0 m, fo = 32.75 kHz: 0.2 to 6.5 m)
- \*12 GP1UM series operating voltage: 4.5 to 5.5 V
- \*13 Operating voltage: 4.5 to 5.5 V
- \*14 Distance to transmitter on optical axis is 0.2 to 8.0 m. Ev < 10 lx when burst wave is input as shown in the right figure.
- \*15 Distance to transmitter on optical axis is 0.2 to 6.5 m. Ev < 10 lx when burst wave is input as shown in the right figure.
- \*16 Types fo = 32.75, 36, 36.7, and 38 kHz are also available.
- \*17 Operating voltage: 2.4 to 5.5 V
- \*18 fo = 56.8 kHz
- \*19 Distance to transmitter on optical axis is 0.2 to 5.0 m. Ev < 10 lx when burst wave is input as shown in the right figure.
- \*20 In addition to the fo = 40 kHz type, types fo = 36, 36.7, and 38 kHz are also available.

<Burst wave>

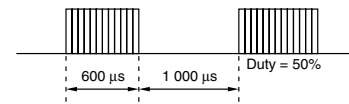

GP1UD series, GP1UM series, GP1UE series have different fo values for each model.

### Notice

In the absence of confirmation by device specification sheets, SHARP takes no responsibility for any defects that may occur in equipment using any SHARP devices shown in catalogs, data books, etc. Except where specially indicated, models listed on this page comply with the RoHS Directive\*. For details, please contact SHARP. \*RoHS Directive: Prohibits use of lead, cadmium, hexavalent chromium, mercury and specific brominated flame retardants (PBBs and PBDEs), with certain exceptions. Contact SHARP in order to obtain the latest device specification sheets before using any SHARP device.



GP1UD28XK00F



GP1UM28XK0VF  
(GP1UE28XK0VF)



GP1UM28RK0VF  
(GP1UE28RK0VF)



GP1UM29QK0VF  
(GP1UE29QK0VF)



GP1UD27XK00F



GP1UM27XK0VF  
(GP1UE27XK0VF)



GP1UM27RK0VF  
(GP1UE27RK0VF)



GP1UV70QS00F  
(GP1UW70QS00F)



GP1UD26XK00F



GP1UM26XK0VF  
(GP1UE26XK0VF)



GP1UM26RK0VF  
(GP1UE26RK0VF)



GP1UX51QS  
(GP1UX31QS)



GP1UD28YK00F



GP1UM28YK0VF  
(GP1UE28YK0VF)



GP1UM28QK0VF  
(GP1UE28QK0VF)



GP1US30XP



GP1UF31xYP0F  
(GP1UF31xXP0F)

**Notice**

In the absence of confirmation by device specification sheets, SHARP takes no responsibility for any defects that may occur in equipment using any SHARP devices shown in catalogs, data books, etc.  
 Except where specially indicated, models listed on this page comply with the RoHS Directive\*. For details, please contact SHARP.  
 \*RoHS Directive: Prohibits use of lead, cadmium, hexavalent chromium, mercury and specific brominated flame retardants (PBBs and PBDEs), with certain exceptions.  
 Contact SHARP in order to obtain the latest device specification sheets before using any SHARP device.

## ■ Switching Power Supplies (Custom)

### ◆ Features

- (1) Satisfies energy saving regulations thanks to the high conversion efficiency
- (2) Compact and high reliability thanks to the modulated main switching and chopper circuits
- (3) EMI filter built-in, low noise design
- (4) Environmentally safe types are also available. [RoHS, lead-free]

### ◆ Specification examples

Applications	LCD TV (20 to 22")	LCD TV (26 to 32")	Laser-beam printer/ Scanner/FAX
Input voltage (V AC)	90 to 110	90 to 264	85 to 138
Input frequency (Hz)	50/60	50/60	50/60
Output voltage (V) (Current capacity)	+24 (1.9 A) +12 (3.5 A)	+24 (5.0 A) +12 (4.0 A) +5 (5.5 A) +5 (1.5 A) +3.3 (3.0 A)	+3.3 (0.25 A) +5 (1.1 A) +12 (0.13 A) +24 (2.0 A)
Rated output power (W)	87.6	213	55.9
Stand-by power loss (W)	0.3 (without load)	0.1	-
Protection circuit	Overcurrent and overvoltage protection		
Configuration	On-board		
Outline dimensions (mm)	118 × 208 × 36	140 × 244 × 35.6	204 × 124 × 40

\* Types with input voltage of AC 100 V, 120 V, 200 V are also available. Types with other specification are also available upon request. For LCD TVs (20" to 22"), an integrated power source with an inverter circuit for backlights is also available.

## ■ Switching Power Supply with Integrated High/Low Voltage Circuit (Custom)

### ◆ Features

- (1) Realizes compact and low cost thanks to the integrated high/low voltage circuit
- (2) Easy connection between high voltage and low voltage circuits
- (3) Highly efficiency energy saving power supply at standby mode can be installed for low voltage circuit
- (4) Environmentally safe types are also available. [RoHS, lead-free]

### ◆ Specifications

		Sharp 'Green Power Supply' adapting with integrated high/low voltage circuit regulation
High voltage	Switching power supply system	Pulse width control or RCC method
	Input voltage (V DC)	24
	Output voltage (kV DC)	+5.5 (+280 μA)/-5.5 (-560 μA), etc.
Low voltage	Switching power supply system	Pulse width control or RCC method
	Input voltage (V AC)	100, 120, 230
	Power capacity (W)	184

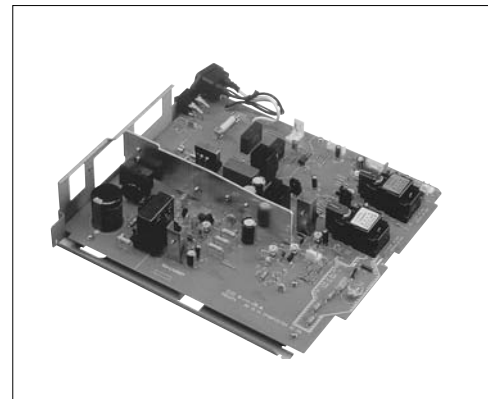

#### Notice

In the absence of confirmation by device specification sheets, SHARP takes no responsibility for any defects that may occur in equipment using any SHARP devices shown in catalogs, data books, etc. Contact SHARP in order to obtain the latest device specification sheets before using any SHARP device.

## ■ Advanced Flex Printed Circuit Boards

The advanced flex printed circuit board is a multilayered composite wiring board comprised of flexible printed circuits (FPC) laminated into a multilayer configuration. The PWBs and FPCs are connected to each other via copper-plated through holes. It is ideal for compact, light-weight equipment design.

### ◆ Features

- (1) For selecting optimal specifications to suit specific applications, special specifications such as for mobile phones are available.
  - Minimum thickness in multi-layer part: 0.26 mm (4-layer), 0.33 mm (6-layer)
  - Minimum pattern width/pitch: 0.06/0.07 mm
  - Flexibility of single/double sided FPC part (dedicated for hinge): More than 200 000 times 180-degree bending of radius 3 mm
- (2) Capable of board-to-board connection without connectors, which enables space-saving and 3-dimensional equipment assembly.
- (3) Through hole plating connection of multi-layer (3 to 8) part to flexible part significantly improves reliability.
- (4) Blind Via Hole (BVH) forming with laser via drilling of small diameter.
- (5) Sheet design provides excellent mountability, equivalent to that of PWB.

### ◆ Outline Specifications

Type	Folding type/Flying tail type	
Min. base thickness	0.26 mm (4-layer), 0.33 mm (6-layer), 0.40 mm (8-layer)	
Min. line width/spacing	0.06/0.07 mm	
Min. through hole diameter	ø0.25 mm	
Min. via hole land diameter	Through hole	Outer layer: ø0.5 mm, Inner layer: ø0.5 mm
	Blind via hole	ø0.09 mm
	Inner via hole	ø0.30 mm
Solder resist	Multi layer: Liquid photo solder resist, FPC: Film cover ray	
Surface finish	Heat-resistant preflux, Ni-Au plating (Ni-Au plating for flying tail)	
Safety standard (UL approval)	94V-0	

Construction of Advanced Flex Board (6-layer sample)

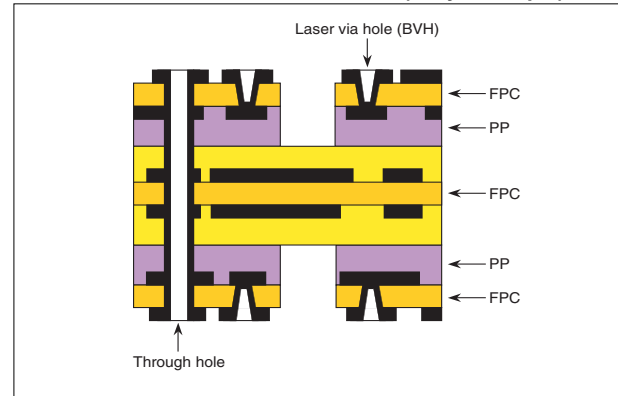

#### Notice

In the absence of confirmation by device specification sheets, SHARP takes no responsibility for any defects that may occur in equipment using any SHARP devices shown in catalogs, data books, etc. Contact SHARP in order to obtain the latest device specification sheets before using any SHARP device.

## ■ Flexible Build-Up Multilayer PCBs

### <Flex-rigid specifications>

Advanced flex specifications are used for the inner layer core material of this build-up multilayer PCB, so the board can handle finer mounting patterns and achieve connectorless between-board connections using an inner layer flexible printed circuit (FPC). This facilitates greater equipment design flexibility and ultra-compact designs.

### ◆ Features

- (1) Multiple build-up layers are connected internally with an FPC, thereby improving connection reliability between multilayer boards and reducing both connection space and connector weight.
- (2) Enables narrow pitch (0.5 mm) CSP and bare chip mounting, and thus greater equipment compactness through ultra-high density mounting.
- (3) Enables via-on-inner-via-hole configurations, and makes it possible to achieve ultra-high density wiring designs.  
(Facilitates a diverse range of designs for greater compactness and thinness.)

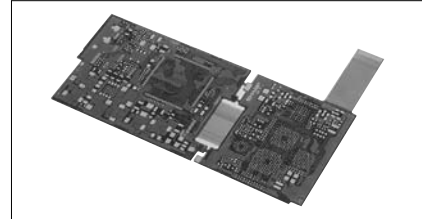

### ◆ Outline Specifications

Type	F1 (6- to 8-layer)	
No. of build-up layers	1 for each side of core layer	
Core layer configuration	3 to 6 layers (Polyimide, FR-4)	
Min. board thickness*1	0.8 mm (6-layer), 0.87 mm (8-layer)	
Via hole diameter	Conformal via hole	ø0.09 mm/ø0.30 mm
	Stacked via hole	—
Land hole diameter	—	
Via-on inner via hole	Available	
Inner via hole diameter	ø0.2 mm	
Min. line width/spacing*2	0.09 mm/0.09 mm	
CSP mountable pitch	0.5 mm	
Safety standard	UL (94V-0)	

\*1 Consult with SHARP if a thinner type is required for special designs.

\*2 Values are measured at build-up portion.

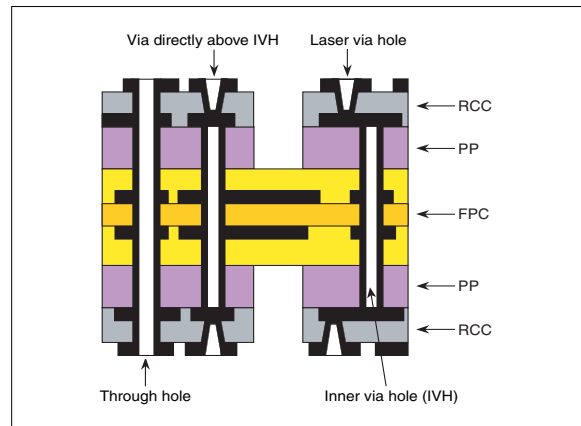

#### Notice

In the absence of confirmation by device specification sheets, SHARP takes no responsibility for any defects that may occur in equipment using any SHARP devices shown in catalogs, data books, etc. Contact SHARP in order to obtain the latest device specification sheets before using any SHARP device.

## Flexible Printed Circuit Boards

The flexible printed circuit board is designed for high space efficiency and product design flexibility, which are now aiming at more compact and higher density mounting. It also contributes to the reduction of assembly process and to the enhancement of the reliability.

### ◆ Features

- (1) High density mounting circuit, SMT and other most suitable flexible PCB are available.
- (2) High precision type for COF with flip chip mounting and wire bonding capabilities and other connector mounting type are available.

### ◆ Standard specifications

Number of layers	One side	Both-side through-hole
Substrate materials	Polyimido film, non-adhesive polyimido	
Design pattern width	0.02 mm (MIN.)	0.05 mm (MIN.)
Design pattern spacing	0.04 mm (MIN.)	0.05 mm (MIN.)
Through-hole / land diameter	—	ø0.1 mm / ø0.3 mm (MIN.)
Cover lay	Polyimido film, heat resistant ink, liquid soldering resist	
Safety standard	UL (94V-0)	

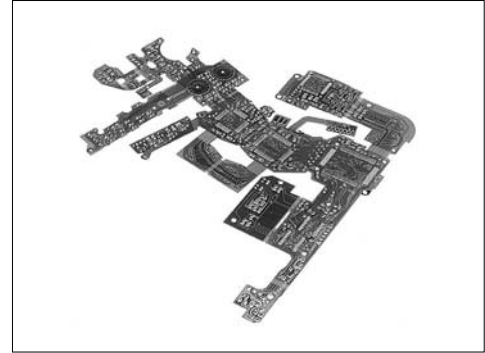

### ◆ Line-up

Multi-layer flexible PCB
Single-layer flexible PCB
Single-side high precision flexible PCB

Both-side flexible PCB
Flex-rigid PCB
Both-side high precision flexible PCB

### Other line-up

Bonding Ni-Au plating
Highly flexible (bending capacity)
High density SMT

#### Notice

In the absence of confirmation by device specification sheets, SHARP takes no responsibility for any defects that may occur in equipment using any SHARP devices shown in catalogs, data books, etc. Contact SHARP in order to obtain the latest device specification sheets before using any SHARP device.

### ■ Slim Combo Drive Pickup <DD-56>

#### ◆ Features

- Thin type pickup compatible with half-inch-height drive (12.7 mm thickness)
- Playback speed: ×8 (DVD-ROM), ×24 (CD-ROM)
- Recording speed: ×24 (CD-R), ×24 (CD-RW)
- DVD-RAM readable
- Outline dimensions: W 38.6 × H 7.3 × D 48.7 (mm)
- Weight: Approx. 15 g

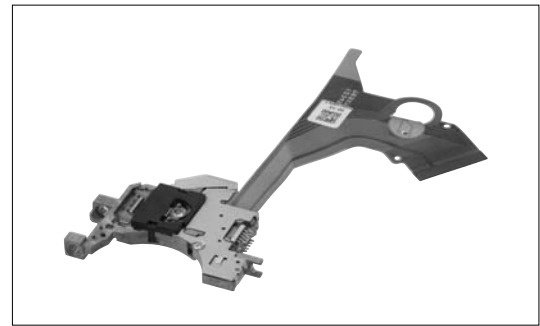

### ■ Slim DVD-ROM Drive Pickup <DD-30>

#### ◆ Features

- Thin type pickup compatible with half-inch-height drive (12.7 mm thickness)
- Playable disk: DVD-ROM/RAM, CD-ROM
- Playback speed: ×8 (DVD-ROM), ×24 (CD-ROM)
- Outline dimensions: W 38.7 × H 7.3 × D 48.7 (mm)
- Weight: Approx. 8 g

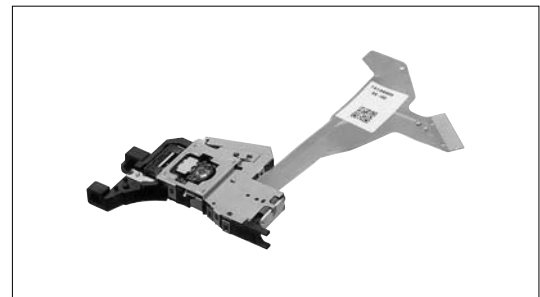

### ■ DVD Pickup for Automotive Use <HPD-66>

#### ◆ Features

- Compact, thin (7.3 mm) pickup
- Playable disk: DVD-ROM, CD-ROM
- Operating temperature: -30 to +85°C
- Outline dimensions: W 30.2 × H 7.3 × D 48.7 (mm)



#### Notice

In the absence of confirmation by device specification sheets, SHARP takes no responsibility for any defects that may occur in equipment using any SHARP devices shown in catalogs, data books, etc. Contact SHARP in order to obtain the latest device specification sheets before using any SHARP device.

## BS

BS1C1UR100A.....	121
BS1F6JP100A.....	122
BS1F6JP300A.....	122
BS1F6JU300A.....	122
BS1R8AR100A.....	122
BS1R8EL100A.....	121
BS1R8EL200A.....	121
BS1R8EL400A.....	121
BS1R8EL500A.....	121
BS2F7HZ6460.....	124
BS2F7VZ0165.....	124
BS2F7VZ0460.....	124
BS2F7VZ7395.....	124
BS2S7HZ0502.....	123
BS2S7HZ6306.....	123
BS520E0F.....	94

## DC

DC2J1AZxxx.....	130
-----------------	-----

## DD

DD-30.....	141
DD-56.....	141

## GA

GA104T1M1MZ.....	99
GA1A1S201WP.....	97
GA1A2S100LY.....	97
GA1A2S100SS.....	97
GA202TXV15J.....	98
GA202TXV15K.....	98
GA210TXV8SY.....	98
GA220T2L1IZ.....	96
GA230TXR1ZY.....	98
GA230TXW6SY.....	98
GA250T6C3SY.....	98
GA250T6C4SY.....	98
GA301TXW5MZ.....	98

## GH0

GH04020A2GE.....	120
GH06P24A2C.....	120
GH07805C2K.....	120
GH07825C2K.....	120
GH07P24C1C.....	120
GH07P24C4C.....	120
GH07P28A1C.....	120
GH07P28A4C.....	120

## GH1

GH16P24A8C.....	120
GH16P30A8C.....	120
GH16P35A8C.....	120
GH17805B2AS.....	120
GH17P24C8C.....	120
GH17P28A8C.....	120

## GL0

GL0ZJ042B0S.....	111
GL0ZS042B0S.....	111
GL0ZV042B0S.....	111

## GL1

GL100MD1MP1.....	101
GL100MNOMP.....	101
GL100MN1MP.....	101
GL100MN3MP.....	101

## GL2

GL2EG6.....	113
GL2HD6.....	113
GL2HY6.....	113
GL2PR6.....	113

## GL3

GL380.....	101
GL381.....	101
GL382.....	101
GL390.....	101
GL390V.....	101
GL3B2402B0SC.....	112
GL3BC302B0S2.....	112
GL3ED8.....	115
GL3EG41.....	113
GL3EG43.....	113
GL3EG44.....	113
GL3EG62.....	113
GL3EG63.....	113
GL3EG8.....	113
GL3G2402B0SC.....	112
GL3HD43.....	113
GL3HD44.....	113
GL3HD62.....	113
GL3HD63.....	113
GL3HD8.....	113
GL3HS43.....	113
GL3HS44.....	113
GL3HS62.....	113
GL3HS63.....	113
GL3HS8.....	113

GL3HY43.....	113
GL3HY44.....	113
GL3HY62.....	113
GL3HY63.....	113
GL3HY8.....	113
GL3JE402B0SE.....	111
GL3JG402B0SE.....	111
GL3JJ404B0SE.....	111
GL3JJ804B0SE.....	111
GL3JR402B0S3.....	111
GL3JS404B0SE.....	111
GL3JS804B0SE.....	111
GL3JV404B0SE.....	111
GL3JV804B0SE.....	111
GL3KG43.....	113
GL3KG44.....	113
GL3KG62.....	113
GL3KG63.....	113
GL3KG8.....	113
GL3PR43.....	113
GL3PR44.....	113
GL3PR63.....	113
GL3PR8.....	113
GL3TR43.....	112
GL3TR44.....	112
GL3TR8.....	112
GL3UR402B0S.....	112
GL3UR43.....	112
GL3UR44.....	112
GL3UR8.....	112
GL3ZJ402B0SE.....	111
GL3ZJ802B0SE.....	111
GL3ZR402B0SE.....	111
GL3ZR802B0SE.....	111
GL3ZS402B0SE.....	111
GL3ZS802B0SE.....	111
GL3ZV402B0SE.....	111
GL3ZV802B0SE.....	111

## GL4

GL4100E0000F.....	101
GL453E00000F.....	101
GL4800E0000F.....	101
GL480E00000F.....	101
GL4EG8.....	113
GL4HD8.....	113
GL4HS8.....	113
GL4HY8.....	113
GL4KG8.....	113
GL4PR8.....	113

## GL5

GL513F.....	101
GL514.....	101
GL537.....	101
GL538.....	101
GL560.....	101
GL561.....	101
GL5CU44.....	115
GL5ED44.....	115
GL5ED5.....	115
GL5ED60.....	115
GL5EG261B0SB.....	113
GL5EG4.....	113
GL5EG40.....	113
GL5EG41.....	113
GL5EG43.....	113
GL5EG44.....	113
GL5EG47.....	113
GL5EG60.....	113
GL5EG8.....	113
GL5EJ502C0X.....	115
GL5EP5.....	115
GL5FG43.....	113
GL5HD261B0SB.....	113
GL5HD4.....	113
GL5HD40.....	113
GL5HD41.....	113
GL5HD43.....	113
GL5HD44.....	113
GL5HD47.....	113
GL5HD60.....	113
GL5HD8.....	113
GL5HP5.....	115
GL5HS40.....	113
GL5HS41.....	113
GL5HS43.....	113
GL5HS44.....	113
GL5HS47.....	113
GL5HS8.....	113
GL5HY40.....	113
GL5HY41.....	113
GL5HY43.....	113
GL5HY44.....	113
GL5HY8.....	113
GL5JJ302B0SE.....	111
GL5JJ7D2D0SE.....	111
GL5JS302B0SE.....	111
GL5JS7D2D0SE.....	111
GL5JV302B0SE.....	111
GL5JV7D2D0SE.....	111
GL5KG41.....	113



GL5KG43.....	113
GL5KG44.....	113
GL5KG8.....	113
GL5PR261B0SB.....	113
GL5PR4.....	113
GL5PR40.....	113
GL5PR41.....	113
GL5PR44.....	113
GL5PR8.....	113
GL5TR43.....	112
GL5TR8.....	112
GL5UR2K.....	112
GL5UR2K1.....	112
GL5UR3K.....	112
GL5UR3K1.....	112
GL5UR44.....	112
GL5ZJ152B0SE.....	111
GL5ZJ302B0SE.....	111
GL5ZR152B0SE.....	111
GL5ZR302B0SE.....	111
GL5ZS152B0SE.....	111
GL5ZS302B0SE.....	111
GL5ZV152B0SE.....	111
GL5ZV302B0SE.....	111

## GL6

GL610T.....	101
GL6CU7.....	115
GL6EG11T.....	113
GL6EG26T.....	113
GL6UR11T.....	112
GL6UR26T.....	112
GL6UR31.....	112
GL6ZJ27.....	111
GL6ZR27.....	111
GL6ZS27.....	111
GL6ZV27.....	111

## GL8

GL8ED5.....	115
GL8EG2.....	113
GL8EG21.....	113
GL8EG22.....	113
GL8EG23.....	113
GL8EG25.....	113
GL8EG26.....	113
GL8EG29.....	113
GL8EG4.....	113
GL8EG42.....	113
GL8EG5.....	113
GL8HD2.....	113
GL8HD21.....	113

GL8HD22.....	113
GL8HD23.....	113
GL8HD25.....	113
GL8HD26.....	113
GL8HD4.....	113
GL8HD42.....	113
GL8HD5.....	113
GL8HP5.....	115
GL8HS21.....	113
GL8HS22.....	113
GL8HS25.....	113
GL8HS29.....	113
GL8HY21.....	113
GL8HY22.....	113
GL8HY23.....	113
GL8HY25.....	113
GL8HY26.....	113
GL8HY29.....	113
GL8HY42.....	113
GL8HY5.....	113
GL8KG21.....	113
GL8KG22.....	113
GL8KG25.....	113
GL8KG26.....	113
GL8KG29.....	113
GL8KG42.....	113
GL8PR21.....	113
GL8PR22.....	113
GL8PR25.....	113
GL8PR26.....	113
GL8PR28.....	113
GL8PR29.....	113
GL8PR42.....	113
GL8TR21.....	112
GL8TR42.....	112
GL8UR21.....	112

## GL9

GL9ED2.....	115
GL9ED4.....	115
GL9EH2.....	115
GL9HP2.....	115

## GM1

GM1BC35370AC.....	116
GM1BC55255AC.....	116
GM1EG35200A.....	117
GM1EG55200A.....	117
GM1GC55310AC.....	116
GM1HD55200A.....	117
GM1HS55200A.....	117
GM1HY55200A.....	117

GM1JE35200AE.....	116
GM1JE55200AE.....	116
GM1JJ35200AE.....	116
GM1JJ40300AE.....	116
GM1JJ55200AE.....	116
GM1JR35200AE.....	116
GM1JS35200AE.....	116
GM1JS40300AE.....	116
GM1JS55200AE.....	116
GM1JV35200AE.....	116
GM1JV40300AE.....	116
GM1JV55200AE.....	116
GM1UR55200A.....	117
GM1WA55311A.....	119
GM1ZJ40300AE.....	116
GM1ZJ80300AE.....	116
GM1ZR40300AE.....	116
GM1ZR80300AE.....	116
GM1ZS40300AE.....	116
GM1ZS80300AE.....	116
GM1ZV40300AE.....	116
GM1ZV80300AE.....	116

## GM4

GM4BC83200AC.....	116
GM4BW63360A.....	118
GM4BW63370A.....	118
GM4BW83380A.....	118
GM4BW83390A.....	118
GM4GC83200AC.....	116
GM4WA10200A.....	119
GM4WA25300A.....	119
GM4ZJ83200AE.....	116
GM4ZR83200AE.....	116
GM4ZS83200AE.....	116
GM4ZV83200AE.....	116

## GM5

GM5BC01250AC.....	116
GM5BC03210Z.....	116
GM5BC05240AC.....	116
GM5BC96260AC.....	116
GM5BC96270A.....	116
GM5BG01210A.....	117
GM5BW01300A.....	118
GM5BW01301A.....	118
GM5BW01311A.....	118
GM5BW05340A.....	118
GM5BW05343A.....	118
GM5BW53340A.....	118
GM5BW94320A.....	118
GM5BW96320A.....	118

GM5BW96370A.....	118
GM5CA96320A.....	118
GM5CV96320A.....	118
GM5CY96320A.....	118
GM5EG95200A.....	117
GM5GC01250AC.....	116
GM5GC03210Z.....	116
GM5GC05240AC.....	116
GM5GC96260AC.....	116
GM5GC96270A.....	116
GM5HD95200A.....	117
GM5SE01200A.....	116
GM5SJ01250AL.....	116
GM5UR95200A.....	117
GM5WA06250A.....	119
GM5WA06250Z.....	119
GM5WA06256A.....	119
GM5WA06256Z.....	119
GM5WA06260A.....	119
GM5WA06270A.....	119
GM5WA94200A.....	119
GM5ZJ01200A.....	116
GM5ZJ03200Z.....	116
GM5ZR01200A.....	116
GM5ZR03200Z.....	116
GM5ZR05240A.....	116
GM5ZR96260AE.....	116
GM5ZR96270A.....	116
GM5ZRB01210A.....	117
GM5ZRG01210A.....	117
GM5ZS01200A.....	116
GM5ZS03200Z.....	116
GM5ZV01200A.....	116
GM5ZV03200Z.....	116
GM5ZV96260AE.....	116
GM5ZV96270A.....	116

## GP1

GP1A037RDKJF.....	90
GP1A038RBK0F.....	90
GP1A038RCK0F.....	90
GP1A044RCKLF.....	90
GP1A046RBZLF.....	90
GP1A047RBZLF.....	90
GP1A047RDZLF.....	90
GP1A05A2J00F.....	87
GP1A05A5J00F.....	87
GP1A05AJ000F.....	87
GP1A05E2J00F.....	87
GP1A05EJ000F.....	87
GP1A073LCS.....	87
GP1A30RJ000F.....	90

GP1A44E1J00F.....	89	GP1S196HCZ0F.....	83	GP1UX31RK.....	135	GP2W1320YP0F.....	132
GP1A50HRJ00F.....	86	GP1S196HCZSF.....	83	GP1UX51QS.....	135	GP2W3020YP.....	132
GP1A51HRJ00F.....	86	GP1S25J0000F.....	83	GP1UX51RK.....	135	GP2W3104YP0F.....	132
GP1A52HRJ00F.....	86	GP1S27J0000F.....	83			GP2W3120YP0F.....	132
GP1A52LRJ00F.....	86	GP1S36J0000F.....	90	<b>GP2</b>		GP2W3240YP.....	133
GP1A53HRJ00F.....	86	GP1S37J0000F.....	83	GP2A200LCS0F.....	88	GP2W3250YP.....	133
GP1A57HRJ00F.....	86	GP1S39J0000F.....	83	GP2A221HRKA.....	91	GP2W3270XP0F.....	133
GP1A58HRJ00F.....	86	GP1S44S1J00F.....	89	GP2A222HCKA.....	91	GP2W3270YP0F.....	133
GP1A73AJ000F.....	87	GP1S50J0000F.....	84	GP2A22J0000F.....	88	GP2WVR01YP0F.....	133
GP1A75EJ000F.....	87	GP1S51VJ000F.....	84	GP2A231LRSAF.....	88	GP2Y0A02YK0F.....	104
GP1A91LCJ00F.....	85	GP1S525VJ00F.....	84	GP2A240LCS0F.....	88	GP2Y0A21YK0F.....	103
GP1A91LRJ00F.....	85	GP1S52VJ000F.....	84	GP2A250LCS0F.....	88	GP2Y0A41SK0F.....	103
GP1A98HCZ0F.....	85	GP1S53VJ000F.....	84	GP2A25BJ000F.....	88	GP2Y0A710K0F.....	104
GP1FA51HRZ0F.....	109	GP1S54J0000F.....	84	GP2A25J0000F.....	88	GP2Y0AH01K0F.....	106
GP1FAV30RK0F.....	109	GP1S566VJ00F.....	84	GP2A25NJ000F.....	88	GP2Y0D02YK0F.....	103
GP1FAV30TK0F.....	108	GP1S56TJ000F.....	84	GP2A28AJ000F.....	88	GP2Y0D21YK0F.....	103
GP1FAV31RK0F.....	109	GP1S58VJ000F.....	84	GP2D032J0000F.....	105	GP2Y0D310K.....	103
GP1FAV31TK0F.....	108	GP1S59J0000F.....	84	GP2D03J0000F.....	105	GP2Y0D340K.....	103
GP1FAV50RK0F.....	109	GP1S74PJ000F.....	84	GP2D061J000F.....	105	GP2Y0D413K0F.....	103
GP1FAV50TK0F.....	108	GP1S93J0000F.....	83	GP2D062J000F.....	105	GP2Y0D805Z0F.....	103
GP1FAV51RK0F.....	109	GP1S94J0000F.....	83	GP2D06J0000F.....	105	GP2Y0D810Z0F.....	103
GP1FAV51TK0F.....	108	GP1S95J0000F.....	83	GP2D071J000F.....	105	GP2Y1010AU0F.....	106
GP1FAV55TK0F.....	108	GP1S96J0000F.....	83	GP2D07J0000F.....	105	GP2Y2A180K0F.....	105
GP1FD210RP0F.....	109	GP1S97J0000F.....	83	GP2D120XJ00F.....	103	GP2Y2A280K0F.....	105
GP1FD210TP0F.....	108	GP1UD26XK00F.....	135	GP2D12J0000F.....	103	GP2Y2D160K0F.....	105
GP1FD310TP0F.....	108	GP1UD27XK00F.....	135	GP2D150AJ00F.....	103	GP2Y2E101K0F.....	105
GP1FD320TP0F.....	108	GP1UD28XK00F.....	135	GP2D150MJ00F.....	103	GP2Y2E301K0F.....	105
GP1FM313TZ0F.....	108	GP1UD28YK00F.....	135	GP2D15J0000F.....	103	GP2Y3A001K0F.....	104
GP1FM513TZ0F.....	108	GP1UE26RK0VF.....	135	GP2L24J0000F.....	88	GP2Y3A002K0F.....	104
GP1FM55HTZ0F.....	108	GP1UE26XK0VF.....	135	GP2S24J0000F.....	87	GP2Y3A003K0F.....	104
GP1FMV31RK0F.....	109	GP1UE27RK0VF.....	135	GP2S27J0000F.....	87	GP2Y40010K0F.....	106
GP1FMV31TK0F.....	108	GP1UE27XK0VF.....	135	GP2S29SJ000F.....	91	GP2Y5D91S00F.....	103
GP1FMV51RK0F.....	109	GP1UE28QK0VF.....	135	GP2S40J0000F.....	87		
GP1FMV51TK0F.....	108	GP1UE28RK0VF.....	135	GP2S60.....	87	<b>GP5</b>	
GP1FP513RK0F.....	109	GP1UE28XK0VF.....	135	GP2S700HCP.....	87	GP5FM5R01AZ.....	110
GP1FP513TK0F.....	108	GP1UE28YK0VF.....	135	GP2TC1J0000F.....	106	GP5FM5T01AZ.....	110
GP1FSV31TK0F.....	108	GP1UE29QK0VF.....	135	GP2U06J0000F.....	106		
GP1FSV51TK0F.....	108	GP1UF31xXP0F.....	135	GP2W0004XP0F.....	132	<b>GW</b>	
GP1L50J0000F.....	85	GP1UF31xYP0F.....	135	GP2W0004YP0F.....	132	GW01M59001PE.....	119
GP1L51J0000F.....	85	GP1UM26RK0VF.....	135	GP2W0110VX.....	133		
GP1L52VJ000F.....	85	GP1UM26XK0VF.....	135	GP2W0110VY.....	133	<b>HPD</b>	
GP1L53VJ000F.....	85	GP1UM27RK0VF.....	135	GP2W0112YP0F.....	133	HPD-66.....	141
GP1L57J0000F.....	85	GP1UM27XK0VF.....	135	GP2W0116YP0F.....	133		
GP1S036HEZ.....	90	GP1UM28QK0VF.....	135	GP2W0118YP0F.....	133	<b>IR2</b>	
GP1S092HCPHF.....	83	GP1UM28RK0VF.....	135	GP2W0150XP0F.....	133	IR2D071.....	52
GP1S093HCZ0F.....	83	GP1UM28XK0VF.....	135	GP2W0150YP0F.....	133	IR2D20U.....	52
GP1S094HCZ0F.....	83	GP1UM28YK0VF.....	135	GP2W1001YP0F.....	132	IR2E46Y6.....	51
GP1S096HCZ0F.....	83	GP1UM29QK0VF.....	135	GP2W1002YP0F.....	132	IR2E47U6.....	51
GP1S097HCZ0F.....	83	GP1US30XP.....	135	GP2W1004YP0F.....	132	IR2E49U.....	51
GP1S194HCZ0F.....	83	GP1UV70QS00F.....	135	GP2W1010YP0F.....	132	IR2E51Y6.....	51
GP1S195HCPHF.....	83	GP1UW70QS00F.....	135	GP2W1302YP0F.....	132		
GP1S195HCZSF.....	83	GP1UX31QS.....	135	GP2W1304YP.....	132		

## IR3

IR3C14N1	52/54
IR3C22N	52
IR3E11A1	30
IR3E11M1	30
IR3E11P1	30
IR3E12M1	30
IR3E13N	30
IR3E13U	30
IR3E2015	30
IR3E2045	30
IR3E3XX	30
IR3M16U	30/50
IR3M17U	49
IR3M18N	48
IR3M19N	48
IR3M30M	30/49/50
IR3M30U	30/49/50
IR3M48U6	50
IR3M49U6	50
IR3M52Y7	50
IR3M55U	19/50
IR3M56N	49
IR3M57N	49
IR3M58M	30/49/50
IR3M58U	30/49/50
IR3M59U	19/22/23/50
IR3M61U	19/50
IR3M63U	19/21/24/50
IR3R55M1	54
IR3R58M1	54
IR3R59N1	54
IR3T46U	51
IR3T46U6	51
IR3T47G	19/20
IR3Y18A1	29/53
IR3Y26A2	29/53
IR3Y26A6	29/53
IR3Y29A1	29/53
IR3Y29B1	29/53
IR3Y30M2	18/24
IR3Y31M1	29/53
IR3Y34M1	29/53
IR3Y37A1	29/53
IR3Y48A3	18/23
IR3Y48A5	18/23
IR3Y48B1	18/23
IR3Y50U6	18/24
IR3Y60U6	18/23
IR3Y63M	29/53

## IRM

IRM046U7	53
IRM047U7	53
IRM048U7	53
IRM053U7	53
IRM060U7	53
IRM063U7	53
IRM065U7	53

## IS

IS1623Q	98
IS1682Q	98
IS1684Q	98
IS471FE	96
IS485E	95
IS486E	95
IS489E	96

## LH1

LH1530	26
LH1537	26
LH1538	26
LH1542	26
LH1548	26
LH1549	26
LH1560	26
LH1562	26
LH1565	26
LH1580	26
LH1583	26
LH15H1	28
LH15JA	28
LH15KA	28
LH15LA	28
LH1687	26
LH168Y	26
LH1691	25/26
LH1694	25
LH169C	27
LH169H	26
LH169J	25
LH16AD	25
LH16AE	25
LH16AF	25
LH16AM	25
LH16AP	27
LH16AR	26
LH16AV	26
LH16AW	25
LH16B5	25
LH16B6	25

LH16B9	25
LH16BP	25

## LH2

LH28F128BFH-PBTL	35
LH28F128BFH-PTTL	35/37
LH28F128BFH-PWTL	37
LH28F128BFHED-PWTLT2	40
LH28F128BFHT-PTTLT1A	40
LH28F128BFHT/B-PBTL75A	38
LH28F128BFHT/B-PTTL75A	38
LH28F128SPH-PTL	37
LH28F128SPHT-PTL12B	40
LH28F160BJH-PBTL	35
LH28F160BJH-PTTL	35
LH28F160BJHE-PBTL70	38
LH28F160BJHE-PTTL70	38
LH28F256BF-PTSL	36
LH28F256BFH-PTTL	37
LH28F256BFHTD-PTTLZ3	40
LH28F256BFN-PTSLZ2	39
LH28F320BFH-PTTL	37
LH28F320BFHE-PTTLE0	40
LH28F512BFBD-PTSL	36
LH28F512BFBD-PTSLZ2	39
LH28F512BFBD-PTSLZ4	39
LH28F512BFND-PTSL	36
LH28F512BFND-PTSLZ1	39
LH28F640BF-PTTL	36
LH28F640BFH-PBTL	35/37
LH28F640BFH-PTTL	35/37
LH28F640BFHE-PBTLHK	40
LH28F640BFHE-PTTLH1A	40
LH28F640BFHE-PTTLHFA	38
LH28F640BFHE/G-PBTL70A	38
LH28F640BFHG-PTTL70A	38
LH28F640BFN-PTTLZ1A	39
LH28F640SPH-PL	37
LH28F640SPHT-PL12B	40
LH28F800BJ-PBTL	35
LH28F800BJ-PTTL	35
LH28F800BJE-PBTL90	38
LH28F800BJE-PTTL90	38
LH28F800BJH-PBTL	35
LH28F800BJH-PTTL	35
LH28F800BJHE-PBTL90	38
LH28F800BJHE-PTTL90	38

## LHF

LHF00L08	36/39
LHF00L09	36/39
LHF00L10	36/39

LHF00L11	36/39
LHF00L14	36/39
LHF00L15	36/39
LHF00L24	36/39
LHF00L25	36/39
LHF00L28	36/39
LHF00L29	36/39
LHF00L34	36/39

## LJ

LJ089MB2S01	14
LJ64H034	14

## LK

LK460D3LZ19	10
LK460D3LZxx	10
LK520D3LZ19	10
LK520D3LZxx	10
LK645D3LZ29	10
LK645D3LZ2U	10

## LM

LM046QB1S02	9
LM050QC1T01	9
LM077VS1T01	9
LM081HB1T01B	9
LM085YB1T01	9
LM089HB1T04	9
LM32019P	9
LM32019T	9

## LQ0

LQ025A3DS01	13
LQ031B5DG01	11
LQ033B5DG02	11
LQ035Q3DG01	9
LQ035Q5DG02	11
LQ038Q3DC01	9
LQ050Q5DR01	9
LQ057Q3DC12	9
LQ057V3DG01	9
LQ061T5GG01	11
LQ064V3DG01	9
LQ064V3DG04	9
LQ065T5DG02	11
LQ065T5GG61	11
LQ065T9DZ03	11
LQ070T5DR05	12
LQ070T5GG21	12
LQ070Y5DE02	12
LQ070Y5DG05	12
LQ070Y5DG06	12

LQ075V3DG01 .....	9
LQ080Y5CGXX .....	12
LQ080Y5DG03 .....	12
LQ080Y5DG04 .....	12
LQ084S3DG01 .....	9
LQ084S3LG01 .....	9
LQ084V1DG21 .....	9
LQ084V3DG01 .....	9
LQ085Y3DG03 .....	9
LQ085Y3DG04 .....	9
LQ088H9DZ03 .....	12

## LQ1

LQ104S1DG21 .....	8
LQ104S1DG31 .....	8
LQ104S1DG61 .....	8
LQ104S1LG21 .....	8
LQ104S1LG31 .....	8
LQ104S1LG61 .....	8
LQ104V1DG21 .....	9
LQ104V1DG51 .....	9
LQ104V1DG61 .....	9
LQ104V1DG64 .....	9
LQ104V1DW02 .....	9
LQ104V1LG61 .....	9
LQ121S1DG41 .....	8
LQ121S1DG61 .....	8
LQ121S1LG41 .....	8
LQ121S1LG61 .....	8
LQ121S1LG64 .....	8
LQ121S1LW01 .....	8
LQ121S7LY01 .....	8
LQ121S7LY11 .....	8
LQ150X1LGB1 .....	8
LQ150X1LGB2 .....	8
LQ150X1LGN2A .....	8
LQ150X1LGN2E .....	8
LQ150X1LW71N .....	8
LQ150X1LW72 .....	8
LQ190E1LW01 .....	8
LQ190E1LW41 .....	8

## LQ2

LQ201U1LW11Z .....	8
LQ201U1LW21 .....	8
LQ231U1LW01 .....	8
LQ231U1LW21 .....	8
LQ281L1LW11 .....	8
LQ281L1LW14 .....	8
LQ283G1TW11 .....	8

## LR3

LR35501 .....	31
LR35501Y .....	31
LR366851 .....	18/23/24
LR36687U .....	18
LR36687Y .....	18
LR36689U .....	18
LR3697A .....	26
LR36B11 .....	18/20
LR385851 .....	18/24
LR386032 .....	19/23
LR386071 .....	19/23
LR38627 .....	19/24
LR386431 .....	18/22
LR386433 .....	18/22
LR38653 .....	18/21
LR38654 .....	19/21
LR38667 .....	18/20
LR38675 .....	18/20
LR38677 .....	18/20
LR38678 .....	18/20
LR38822A .....	27
LR38825 .....	27
LR38826 .....	27
LR38844A .....	28
LR38869A .....	27
LR388733 .....	31
LR38875 .....	31
LR38886 .....	31
LR38888 .....	31
LR388B3 .....	31
LR388B6 .....	31
LR388B61 .....	31
LR388D0 .....	27
LR388D1 .....	27/31

## LR5

LR550R03 .....	34
----------------	----

## LRS

LRS1871A .....	41
LRS1872A .....	41
LRS18831 .....	41
LRS18841 .....	41
LRS1890A .....	41
LRS1897 .....	41
LRS18A6 .....	41
LRS18AZ .....	41
LRS18B0 .....	41
LRS18BK .....	41
LRS18BL .....	41

LRS18BN .....	41
LRS18BT .....	41
LRS18C8C .....	41
LRS18CCA .....	41
LRS18CJ .....	41
LRS18CK .....	41
LRS18CP .....	41
LRS5751 .....	29/53
LRS5752 .....	29/53

## LS

LS022Q8UX05 .....	13
LS025A8DZ01 .....	13
LS027T3DG01 .....	13
LS028B7UX01 .....	13

## LT1

LT1D40A .....	117
LT1D67A .....	117
LT1E40A .....	117
LT1E67A .....	117
LT1ED67A .....	118
LT1EH67A .....	118
LT1F67A .....	117
LT1F67AF .....	117
LT1H40A .....	117
LT1H67A .....	117
LT1JS67A .....	116
LT1JV67A .....	116
LT1K40A .....	117
LT1K67A .....	117
LT1KS67A .....	118
LT1P40A .....	117
LT1P67A .....	117
LT1S40A .....	117
LT1S67A .....	117
LT1U40A .....	117
LT1U67A .....	117

## LT3

LT3D31W .....	113
LT3D65W .....	113
LT3E31W .....	113
LT3E65W .....	113
LT3H31W .....	113
LT3H65W .....	113
LT3P31W .....	113
LT3P65W .....	113
LT3S65W .....	113

## LZ

LZ0P392N .....	15
----------------	----

LZ0P393D .....	15
LZ0P393M .....	15
LZ0P394K .....	15
LZ0P3955 .....	15
LZ0P395V .....	15
LZ0P396K .....	15
LZ0P399A .....	15
LZ0P39AG .....	15
LZ0P39DS .....	15
LZ2316A3 .....	17/24
LZ2326A3 .....	17/24

## PC1

PC1231xNSZ0F .....	70
PC123J0000F .....	70

## PC2

PC2SD11NTZAF .....	76
--------------------	----

## PC3

PC352NJ000F .....	68
PC354NJ0000F .....	68
PC355NJ0000F .....	68
PC357NJ0000F .....	68
PC364NJ0000F .....	68
PC365NJ0000F .....	68
PC367NJ0000F .....	68
PC3H2J00000F .....	69
PC3H3J00000F .....	69
PC3H41xNIP0F .....	69
PC3H4J00000F .....	69
PC3H510NIP0F .....	69
PC3H5J00000F .....	69
PC3H71xNIP0F .....	69
PC3H7J00000F .....	69
PC3HU7NYIP0F .....	69
PC3Q41xNIP0F .....	69
PC3Q510NIP0F .....	69
PC3Q62J0000F .....	69
PC3Q63J0000F .....	69
PC3Q64QJ000F .....	69
PC3Q65J0000F .....	69
PC3Q67QJ000F .....	69
PC3Q71xNIP0F .....	69
PC3SD11NTZAF .....	76
PC3SD11NTZBF .....	76
PC3SD11NTZCF .....	76
PC3SD11YTZDF .....	76
PC3SD12NTZAF .....	76
PC3SD21NTZBF .....	77
PC3SD21NTZCF .....	77
PC3SD21NTZDF .....	77

PC3SD21YTZEF	77
PC3SD23YTZCF	77
PC3SF11YVZAF	76
PC3SF11YVZBF	76
PC3SF21YVZAF	77
PC3SF21YVZBF	77
PC3SF23YVZSF	77
PC3SG11YIZ0F	76
PC3SG21YIZ0F	77
PC3SH11YFZAF	76
PC3SH13YFZAF	76
PC3SH21YFZBF	77
PC3ST11NSZAF	76
PC3ST21NSZBF	77

## PC4

PC400J00000F	72
PC401J00000F	72
PC410L0NIP0F	72
PC410S0NIP0F	72
PC411L0NIP0F	72
PC411S0NIP0F	72
PC412S0NIP0F	72
PC451J00000F	68
PC456L0NIP0F	72
PC457L0NIP0F	73
PC457S0NIP0F	73
PC4D10SNIP0F	72
PC4H510NIP0F	69
PC4H520NIP0F	69
PC4SD11NTZBF	76
PC4SD11NTZCF	76
PC4SD21NTZCF	77
PC4SD21NTZDF	77
PC4SF11YVZAF	76
PC4SF11YVZBF	76
PC4SF21YVZBF	77
PC4SF21YVZCF	77

## PC7

PC713V0NSZXF	71
PC714V0NSZXF	71
PC715V0NSZXF	71
PC724V0NSZXF	71
PC725V0NSZXF	71

## PC8

PC81100NSZ0F	70
PC814xNSZ0F	70
PC814XJ0000F	70
PC8150NSZ0F	70
PC815XJ0000F	70

PC8171xNSZ0F	70
PC817XJ0000F	70
PC844XJ0000F	70
PC845XJ0000F	70
PC847XJ0000F	70
PC851XJ0000F	70
PC852XJ0000F	70
PC853XJ0000F	70

## PC9

PC900V0NSZXF	73
PC901V0NSZXF	73
PC910L0NSZ0F	73
PC911L0NSZ0F	73
PC912L0NSZ0F	73
PC923L0NSZ0F	74
PC924L0NSZ0F	74
PC925L0NSZ0F	74
PC928J00000F	74
PC929J00000F	74
PC942J00000F	74
PC956L0NSZ0F	73
PC957L0NSZ0F	74

## PD

PD100MC0MP	94
PD100MF0MP	94
PD101SC0SS0F	95
PD30CMC31MZ	95
PD3122FE000F	94
PD410PI2E00F	94
PD411PI2E00F	94
PD412PI2E00F	94
PD413PI2E00F	94
PD49PIE0000F	94
PD60T	94

## PQ0

PQ015YZ01ZPH	46
PQ015YZ5MZPH	46
PQ033ES1MXPQ	43
PQ033ES3MXPQ	43
PQ035ZM02ZPH	46
PQ035ZN01ZPH	46
PQ035ZN1HZPH	46
PQ050ES1MXPQ	43
PQ050ES3MXPQ	43
PQ05VY053ZPH	47
PQ05VY3H3ZPH	47
PQ070VK01FZH	42
PQ070VK02FZH	42
PQ070XF01SZH	42

PQ070XF02SZH	42
PQ070XH01ZPH	47
PQ070XH02ZPH	47
PQ070XN01ZPH	45
PQ070XNA1ZPH	45
PQ070XNAHZPH	45
PQ070XNB1ZPH	45
PQ070XZ01ZPH	45
PQ070XZ02ZPH	46
PQ070XZ1HZPH	46
PQ070XZ5MZPH series	45
PQ07VR5MAPH series	45

## PQ1

PQ150RWA2SZH	42
PQ150VB01FZH	42
PQ150VB02FZH	42
PQ15RW08J00H	42
PQ15RW11J00H	42
PQ15RW21J00H	42
PQ1CG2032FZH	49
PQ1CG2032RZH	49
PQ1CG21H2FZH	49
PQ1CG21H2RZH	49
PQ1CG3032FZH	49
PQ1CG3032RZH	49
PQ1CG38M2FZH	49
PQ1CG38M2RZH	49
PQ1CG41H2FZH	49
PQ1CG41H2RZH	49
PQ1CX12H2ZPQ	48
PQ1CX22H2ZPQ	48
PQ1CX41H2ZPQ	48
PQ1CY1032ZPH	48
PQ1CYxx3HZPH series	48
PQ1CYxx3LZPH series	48
PQ1CZ21H2ZPH	48
PQ1CZ38M2ZPH series	48
PQ1CZ41H2ZPH	48
PQ1DX095MZPQ	47
PQ1DX125MZPQ	47
PQ1KAxx3MZPH series	44
PQ1Kxx3M2ZPH series	44
PQ1LAX95MSPQ	44
PQ1LAXx3MSPQ	44
PQ1LAXx5MSP series	44
PQ1Lxx3M2SPQ	44
PQ1MGX38MSPQ	44
PQ1MGxx8MSPQ	44
PQ1MX55M2SPQ	44
PQ1Mxx5M2SPQ	44
PQ1Nxx3MxSPQ	44

PQ1RxxJ0000H series	44
PQ1Uxx1M2ZPH series	44
PQ1XAxx1M2ZPH series	44
PQ1Xxx1M2ZPH series	44

## PQ2

PQ200WN3MZPH	46
PQ200WNA1ZPH	46
PQ20RX05J00H	42
PQ20RX11J00H	42
PQ20VZ11J00H	46
PQ20VZ51J00H	46
PQ20WZ11J00H	46
PQ20WZ51J00H	46
PQ2CF1J0000H	49
PQ2Lxxx2MSPQ	44

## PQ3

PQ30RV11J00H	42
PQ30RV21J00H	42
PQ30RV31J00H	42
PQ3DZ13J000H	45
PQ3DZ53J000H	45
PQ3RD083J00H	42
PQ3RD13J000H	42
PQ3RD23J000H	42
PQ3RF23J000H	42
PQ3RF33J000H	42

## PQ5

PQ5CB11X1AP	48
PQ5EV3J0000H	43
PQ5EV5J0000H	43
PQ5EV7J0000H	43

## PQ6

PQ6CB11X1AP	48/51
PQ6CB11X1CP	48/51
PQ6CU11X1APQ	48/51
PQ6CU12X2APQ	48
PQ6RD083J00H	42

## PQ7

PQ7L2010BP	48/51
PQ7RV4J0000H	42

## PQx

PQxxDZ11J00H series	45
PQxxDZ51J00H series	45
PQxxRA11J00H series	42
PQxxRD08J00H series	42
PQxxRD11J00H series	42

PQxxRD21J00H series.....	42
PQxxRF11J00H series.....	42
PQxxRF21J00H series.....	42
PQxxRH11J00H series.....	42
PQxxDNA1ZPH series.....	45
PQxxDZ01ZPH series.....	45
PQxxEF01SZH series.....	42
PQxxEF02SZH series.....	42
PQxxEH01ZPH.....	47
PQxxEH02ZPH.....	47
PQxxEN01ZPH series.....	45
PQxxENA1ZPH series.....	45
PQxxENA1ZPH series.....	45
PQxxENAHZPH series.....	45
PQxxEZ01ZPH series.....	45
PQxxEZ02ZPH series.....	45
PQxxEZ1HZPH series.....	45
PQxxEZ5MZPH series.....	45
PQxxFZ01ZPH series.....	45
PQxxFZ5MZPH series.....	45
PQxxGM02ZPH.....	45
PQxxGN01ZPH series.....	45
PQxxGN1HZPH series.....	45
PQxxRDA1SZH series.....	42
PQxxRDA2SZH series.....	42
PQxxY053ZPH.....	47
PQxxY3H3ZPH.....	47

## PR

PR22MA11NTZF.....	79
PR23MF11NSZF.....	79
PR26MF11NSZF.....	79
PR26MF12NSZF.....	79
PR26MF21NSZF.....	79
PR29MF11NSZF.....	79
PR29MF12NSZF.....	79
PR29MF21NSZF.....	79
PR31MA11NTZF.....	79
PR32MA11NTZF.....	79
PR33MF51NSZF.....	79
PR36MF12NSZF.....	79
PR36MF21NSZF.....	79
PR36MF22NSZF.....	79
PR36MF51NSZF.....	79
PR39MF11NSZF.....	79
PR39MF12NSZF.....	79
PR39MF21NSZF.....	79
PR39MF22NSZF.....	79
PR39MF51NSZF.....	79
PR3BMF11NSZF.....	79
PR3BMF21NSZF.....	79

## PT

PT100MCOMP.....	93
PT100MF0MP.....	93
PT100MF1MP.....	93
PT200MCOMP.....	93
PT202MR0MP1.....	93
PT380.....	93
PT380F.....	93
PT381.....	93
PT381F.....	93
PT4800E0000F.....	93
PT4800FE000F.....	93
PT480E00000F.....	93
PT480FE0000F.....	93
PT4810E0000F.....	93
PT4810FE000F.....	93
PT481E0000F.....	93
PT481FE0000F.....	93
PT483F1E000F.....	93
PT4850FE000F.....	93
PT491FE0000F.....	93
PT493FE0000F.....	93
PT501.....	93
PT510.....	93
PT550.....	93
PT550F.....	93
PT600T.....	93
PT601T.....	93

## RB

RB5P0010M2.....	29/53
RB5P0020M2.....	29/53
RB5P0050M2.....	29/53
RB5P0060M2.....	29/53
RB5P006AM2.....	29/53
RB5P0070M.....	29/53
RB5P0090M.....	29/53

## RJ

RJ21V3BC0ET.....	16/20
RJ21W3BB0ET.....	16/20
RJ21W3BC0ET.....	16/20
RJ21Y3BA0ET.....	16/20
RJ2311AA0PB.....	16/17/21/22/23/24
RJ2311BA0PB.....	16/21/22/23/24
RJ2321AA0PB.....	16/21/22/23/24
RJ2321BA0PB.....	16/21/22/23/24
RJ2351AA0BB.....	16/21/22/23/24
RJ2351BA0AB.....	16/21/22/23/24
RJ2361AA0BB.....	16/21/22/23/24
RJ2361BA0AB.....	16/21/22/23/24

RJ23S3BD0ET.....	16/20
RJ23S3BE0BT.....	16/20
RJ23S3CD0ET.....	16/20
RJ23S3CE0BT.....	16/20
RJ23T3BB0ET.....	16/20
RJ23T3BC0BT.....	16/20
RJ23T3CB0ET.....	16/20
RJ23T3CC0BT.....	16/20
RJ23U3BA0ET.....	16/20
RJ23U3BC0BT.....	16/20
RJ23U3CA0ET.....	16/20
RJ23U3CC0BT.....	16/20
RJ23V3BA0BT.....	16/20
RJ23V3CA0BT.....	16/20
RJ2411AA0PB.....	17/21/22
RJ2411AB0PB.....	17/21/22/23/24
RJ2411BA0PB.....	17/21/22
RJ2411BB0PB.....	17/21/22/23/24
RJ2411CA0PB.....	21
RJ2421AB0PB.....	17/21/22/23/24
RJ2421BB0PB.....	17/21/22/23/24
RJ2451AA0PB.....	17/21/22/23/24
RJ2451BA0PB.....	17/21/22/23/24
RJ2461AA0PB.....	17/21/22/23/24
RJ2461BA0PB.....	17/21/22/23/24

## RW

RW-4020.....	34
RW-4040.....	34

## S1

S101S05F.....	80
S101S06F.....	80
S101S16F.....	80
S102S01F.....	80
S102S02F.....	80
S102S11F.....	80
S102S12F.....	80
S102T01F.....	80
S102T02F.....	80
S108T01F.....	80
S108T02F.....	80
S112S01F.....	80
S116S01F.....	80
S116S02F.....	80

## S2

S201S06F.....	80
S202S01F.....	80
S202S02F.....	80
S202S11F.....	81
S202S12F.....	81

S202S15F.....	80
S202SE1F.....	81
S202SE2F.....	81
S202T01F.....	80
S202T02F.....	80
S208T01F.....	80
S208T02F.....	80
S212S01F.....	80
S216S01F.....	80
S216S02F.....	80
S216SE1F.....	81
S216SE2F.....	81
S2S3000F.....	76
S2S4000F.....	77
S2S5A00F.....	76

## VA

VA1H1ED5265.....	126
VA1J5JF7007.....	126
VA1K5ED5255.....	126
VA1R5JF7002.....	125
VA1T1ED5065.....	126
VA1Y2ED1401.....	127
VA1Y2UF2307.....	127
VA1Y2UF2312.....	127
VA35JZ9904.....	129
VA35JZ9910.....	129

## VT

VT1Y5CD201.....	128
VT1Y5ED211.....	128
VT1Y5JB201.....	128
VT1Y5JF201.....	128
VT1Y5UF201.....	128
VT2W5CD551.....	127

# SHARP CORPORATION

22-22, NAGAIKE-CHO, ABENO-KU, OSAKA 545-8522, JAPAN

■ Specifications are subject to change without notice.  
 ■ All screen images are simulated.

## U.S.A

### SHARP MICROELECTRONICS OF THE AMERICAS

■ North American Head Office  
 5700 NW Pacific Rim Boulevard  
 Camas, WA 98607 USA  
 PHONE: +1-360-834-2500  
 FAX: +1-360-834-8903  
<http://www.sharpsma.com>

#### ■ Western Area

1980 Zanker Road,  
 San Jose, CA 95112  
 PHONE: +1-408-436-4900  
 FAX: +1-408-436-0924  
 5901 Bolsa Ave.  
 Huntington Beach, CA 92647  
 PHONE: +1-714-903-4600  
 FAX: +1-714-903-0295

#### ■ Eastern Area

85 W. Algonquin Road, Suite 280  
 Arlington Heights, IL 60005  
 PHONE: +1-847-258-2750  
 FAX: +1-847-439-2479  
 8911 Capitol of Texas Hwy., Suite 3130  
 Austin, TX 78759  
 PHONE: +1-512-349-7262  
 FAX: +1-512-349-7002  
 3001 West Big Beaver Road, Suite 722  
 Troy, MI 48084  
 PHONE: +1-248-458-1527  
 FAX: +1-248-458-6255  
 200 Wheeler Rd.,  
 Burlington, MA 01803  
 PHONE: +1-781-270-7979  
 FAX: +1-781-229-9117  
 8000 Regency Parkway, Suite 280  
 Cary, NC 27518  
 PHONE: +1-919-460-0695  
 FAX: +1-919-460-0795

## EUROPE

### SHARP MICROELECTRONICS EUROPE a division of Sharp Electronics (Europe) GmbH

■ European Head Office  
 Sonninstrasse 3, 20097, Hamburg, Germany  
 PHONE: +49-1805-073507  
 FAX: +49-40-2376-2232  
<http://www.sharpsme.com>

#### ■ Germany:

Munich Office  
 Landsberger Strasse 398, 81241 Munich, Germany  
 PHONE: +49-89-54 6842 0

#### ■ France:

Paris Office  
 1 Rue Raoul Follereau Bussy Saint Georges  
 F-77608 Marne la Vallee Cedex 3, France  
 PHONE: +33-1 6476 22 22  
 FAX: +33-1 6476 22 23

#### ■ Italy:

Milano Office  
 Centro Direzionale Colleoni  
 Palazzo Taurus Ingresso 2  
 20041 Agrate Brianza, Milano, Italy  
 PHONE: +39-039-689-99 46  
 FAX: +39-039-689-99 48

#### ■ U.K.:

London Office  
 Venture House, 2 Arlington Square,  
 Downshire Way, Bracknell, Berkshire, RG12 1WA,  
 United Kingdom  
 PHONE: +44-1344-86 99 22  
 FAX: +44-1344-36 09 03

#### ■ Sweden:

Nordic Office  
 Box 14098 16714 Bromma Stockholm, Sweden  
 PHONE: +46-8634-3600  
 FAX: +46-8634-3620

## ASIA

### SHARP ELECTRONICS (SHANGHAI) CO., LTD. Microelectronics Sales & Marketing Division

16F-1602, King Tower, 28 Xin Jin Qiao Road,  
 Pudong DIST, Shanghai 201206 P.R. China  
 PHONE: +86-21-5854-7710/21-5834-6056  
 FAX: +86-21-5030-4510/21-5834-6057  
<http://ses.sharpmicro.com>

#### ■ Registered Address

No. 273, De Bao Road, Xin Development BLDG  
 58 Wai Gao Qiao Free Trade Zone, Shanghai  
 200131, P.R. China

#### ■ Beijing Office

Room 1905, Lian He Building, No. 20  
 Chao Wai Da Road, Chao Yang DIST  
 Beijing 100020, P.R. China  
 PHONE: +86-10-65886598  
 FAX: +86-10-65880773

#### SHARP-ROXY (HONG KONG) LTD.

Device Sales Division, 17/F, Admiralty Centre,  
 Tower 1, 18 Harcourt Road, Hong Kong  
 PHONE: +852-28229311  
 FAX: +852-28660779  
<http://srh.sharpmicro.com>

#### ■ Shenzhen Representative Office

Room 602-603, 6/F, International Chamber of  
 Commerce Tower, 128 Fuhua Rd. 3, CBD, Futian  
 District, Shenzhen  
 PHONE: +86-755-88313505  
 FAX: +86-755-88313515

#### SHARP ELECTRONIC COMPONENTS (TAIWAN) CORPORATION

8F-A, No. 16, Sec. 4, Nanking E. Rd.,  
 Taipei, Taiwan  
 PHONE: +886-2-2577-7341  
 FAX: +886-2-2577-7326/2-2577-7328

#### SHARP ELECTRONICS (SINGAPORE) PTE., LTD.

491B River Valley Road, #09-02/03/04  
 Valley Point, Singapore 248373  
 PHONE: +65-63042500  
 FAX: +65-63042598  
<http://www.sesl-sharp.com>

#### SHARP ELECTRONIC COMPONENTS (KOREA) CORPORATION

5F, Jeil Pharm B/D, 745-5, Banpo 1-dong,  
 Seocho-ku, Seoul 137-810 Korea  
 PHONE: +82-2-711-5813  
 FAX: +82-2-711-5819



The following facilities of Sharp Corporation have been certified under the ISO 14001 international standard for environmental management systems. In our products and manufacturing processes, we are actively engaged in environmental preservation efforts.

Facility	Certificate No.	Registration Date
Headquarters and Associated Companies Group	EC97J1037	June 24, 1997
Katsuragi Works	EC99J2006	June 25, 1996
Large-Scale IC Group (Fukuyama)	EC99J2016	September 24, 1996
Nara Plant	EC99J2021	September 24, 1996
Advanced Development and Planning Center	EC99J2038	December 3, 1996
Mie Factory	EC99J2051	January 28, 1997
Electronic Components (Elecrom Group) Mihara Plant	EC03J0180	November 17, 2003
AVC Liquid Crystal Display Group	EC04J0284	October 12, 2004
Communication Systems Group Hiroshima Plant	JQA-EM5312	April 14, 2006
Appliance Systems Group	JQA-EM5554	November 10, 2006
Audio-Visual Systems Group Tochigi Plant	JQA-EM0339	February 26, 1999



The following facilities of Sharp Corporation have been certified under the ISO 9001:2000 international standard for quality management systems.

Certifying organization: Japan Quality Assurance Organization (JQA) [JAB certified]

Facility	Certificate No.
Mobile Liquid Crystal Display Group	JQA-QM3776
AVC Liquid Crystal Display Group	JQA-QMA11778
Large-Scale IC Group	JQA-QM8688



The following facility of Sharp Corporation has been certified as a manufacturer under the IEC Quality Assessment System for Electronic Components.

Applicable standards: ISO 9001:2000 and JIS Q 9001:2000  
 Certifying organization: Reliability Center for Electronic Components of Japan (RCJ)

Facility	Certificate No.
Compound Semiconductor Systems Division	RCJ-94M-23J

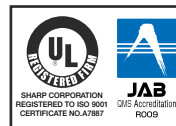

The following facility of Sharp Corporation has been certified under the ISO 9001:2000 international standard for quality management systems.

Certifying organization: IL Inc. [JAB certified]

Facility	Certificate No.
Compound Semiconductor Systems Division	A7887

Distributed by

The contents of this catalog are current as of June, 2007.